

ŠPINA®

KATALOG 2023



SADRŽAJ

Uvod	6				
Keramičke pločice	9				
Beton					
BLUSTYLE Concrete Jungle	10				
CAESAR Join	12				
CAESAR Materica	16				
CAESAR One	20				
CERAMICHEITALIANE Genesis Blok Out	22				
CERAMICHEITALIANE Materika	24				
CERAMICHEITALIANE More	26				
CERIM Maps	28				
COTTO D'ESTE X-Beton	30				
FLOOR GRES Industrial	32				
IMOLA Azuma	36				
IMOLA Azuma Up	40				
IMOLA Blox	42				
LEONARDO Waterfront	44				
LEA Concreto	46				
PRISSMACER Nunky	50				
PRISSMACER Start	52				
Mramor					
CAESAR Anima	56				
CAESAR Anima Ever	60				
CERIM Timeless	62				
COTTO D'ESTE Allure	66				
COTTO D'ESTE Vanity	68				
IMOLA The Room	70				
LEA Delight	74				
PRISSMACER	76				
PRISSMACER Opera	78				
REX Etoile de Rex	80				
REX Reves de Rex	84				
Modern					
CAESAR Alchemy	86				
CAESAR Relate Flame	90				
CERIM Match Up	92				
COTTO D'ESTE Metal	96				
IMOLA Tube	98				
LEONARDO Overcome	100				
Terrazzo					
CAESAR Autore	102				
Kamen					
BLUSTYLE Yosemite	104				
CAESAR Portraits	106				
CAESAR Shapes Of Italy	108				
CDC Sensi	112				
CERAMICHEITALIANE Ethik	116				
CERAMICHEITALIANE Pietra Ionica	118				
CERIM Rock Salt	120				
COTTO D'ESTE Blend Stone	124				
COTTO D'ESTE Limestone	128				
COTTO D'ESTE Lithos	132				
COTTO D'ESTE Secret Stone	136				
COTTO D'ESTE Pietra d'Iseo	138				
FLOOR GRES Airtech	140				
LEA Anthology	144				
LEA Nextone	146				
LEA Waterfall	150				
REX La Roche	154				
REX Matieres	158				
Whites					
PRISSMACER Blanco	162				
Dekorativa					
EQUIPE Arrow	164				
EQUIPE Art Nouveau	166				
EQUIPE Artisan	170				
EQUIPE Mallorca	172				
EQUIPE Chevron Wall	174				
EQUIPE Scale	176				
MUTINA Azulej	178				
MUTINA Dechirer	180				
Imitacija drva					
BLUSTYLE Barrique	182				
CAESAR Arthis	184				
CAESAR Fabula	186				
CAESAR Life	188				
CAESAR Meet	190				
LEA Bio Select	192				
PRISSMACER Miro	196				
PRISSMACER Outi	198				
Mozaik					
VIDREPUR	200				
Sanitarije	203				
CATALANO Horizon	204				
CATALANO Green Lux	206				
CATALANO Green	208				
CATALANO New Premium	210				
CATALANO Zero	212				
CATALANO Gold&Silver	214				
CATALANO Canova Royal	216				
CATALANO Namještaj	218				
CATALANO WC školjke i bidei	220				
IDEAL STANDARD Strada	222				
Kupaonski namještaj					
INDA Namještaj	224				
INDA	228				
ARCOM	230				

Ogledala		INDA Lea	297	Tuš kabine	
VANITA&CASA	232	INDA Mito	297	NOVELLINI Kali	326
<hr/>		INDA Divo	298	NOVELLINI	328
Miješalice	237	INDA Lea	298	DUKA	330
<hr/>		INDA One	299	UNIVERZALNO	332
HANSGROHE Focus	238	INDA	300	<hr/>	
HANSGROHE Talis S	240	GEESA Nemox	302	Radijatori - Mini bazeni - Parketi - Premaz	335
HANSGROHE Vivenis	242	HANSGROHE	304	<hr/>	
HANSGROHE Talis E	244	HANSGROHE AddStoris	305	Radijatori	
HANSGROHE Metropol	248	GEDY	306	CALEIDO Ulisse	336
HANSGROHE Pulsify	252	GEDY Edera Plus	307	TUBES	338
HANSGROHE Zona tuširanja	254	GEDY Pirenei	308	Mini bazeni	
PAFFONI Green	262	GEDY	309	NOVELLINI	340
PAFFONI Stick	264	<hr/>		Parketi	
PAFFONI Tango	265	Kade - Tuš kade - Kanalice - Tuš kabine	311	IPF	342
PAFFONI Light	266	<hr/>		Premazi	
PAFFONI Rock	268	Tuš kade		KERAKOLL Warm Collection	344
PAFFONI Tilt	269	BETTE BetteUltra	312	<hr/>	
PAFFONI Joker	270	BETTE BetteFloor	313	Vodokotlići i aktivacijske tipke - Ljepila - Hidroizolacija i grijanje	347
PAFFONI Joker	270	BETTE BetteFloor Side	314	<hr/>	
PAFFONI Jo	272	NOVELLINI Olympic Plus	315	Vodokotlići i aktivacijske tipke	
PAFFONI Ringo	274	NOVELLINI Custom	316	GEBERIT	348
PAFFONI Light	276	NOVELLINI Novosolid	317	TECE	352
PAFFONI Zona tuširanja	278	NOVELLINI Olympic / Victory	318	Ljepila	
IDEAL STANDARD Ceralina	282	GSI / IDEAL STANDARD	319	KERAKOLL	356
AXOR	284	Tuš kanalice		MAPEI	358
GESSI	286	EASY DRAIN	320	Hidroizolacija i grijanje	
Kuhinjske miješalice		GEBERIT	322	SCHLÜTER SYSTEMS	360
<hr/>		Ugradbene kade			
HANSGROHE Kuhinjske miješalice i sudoperi	288	KOLPA SAN / NOVELLINI / BETTE	323		
PAFFONI	290	Samostojeće kade			
Kuhinjske miješalice	290	FLAMINIA / JACUZZI	324		
UNIVERZALNO	292	KOLPA SAN	325		
<hr/>					
Galanterija	295				
<hr/>					
INDA	296				

UVOD

Naše poduzeće osnovano je 1990. godine kao mala obiteljska trgovina u Poreču. Od tada do danas, uvijek smo težili ka istom cilju – biti najbolji u poslu koji radimo. Do današnjeg dana, otvorili smo poslovnice diljem Hrvatske te nas se može pronaći u Poreču, Zagrebu, Rijeci, Puli, Varaždinu i Dugopolju. Tijekom dugog niza godina vrijedno smo radili i kontinuirano se educirali kako bismo našim klijentima mogli ponuditi najbolje od asortimana te najbolje od usluge. Pouzdan smo partner brojnim arhitektima i dizajnerima interijera, velikim investitorima i maloprodajnim kupcima. Kako bismo nudili samo najbolje, ostvarujemo suradnju s probranim dobavljačima koji su se na tržištu istaknuli kvalitetom te lijepim dizajnom. Smatramo kako je estetika vrlo važna

te iz tog razloga pazimo na svaki detalj prilikom odabira asortimana.

Špina je mjesto koje vam pruža uistinu širok spektar mogućnosti te pokriva gotovo sve ideje koje možete imati. Mi smo tu da s velikom strašću, ljubavi i pažnjom opremimo i oplemenimo vaš prostor. Bilo da se radi o interijeru ili eksterijeru, hotelu, wellnessu, privatnoj kući, stanu ili bilo kojem ambijentu, s jednakim entuzijazmom radimo na vašem projektu. Želja nam je da se u našim salonima, neovisno o lokaciji, osjećate ugodno i opušteno te da u širokom izboru asortimana pronađete točno ono što ste poželjeli uz pomoć našeg educiranog tima.

Robert Jurišević, direktor

Katalog sadrži samo dio cjelokupnog asortimana naših partnera.

U našoj ponudi nalazi se cjelokupan asortiman partnera s kojima surađujemo.

Iskazane cijene vrijede na dan izlaska kataloga. Asortiman i cijene u katalogu podložni su promjenama, s obzirom na promjene kod naših dobavljača te promjene na tržištu. Cijene mogu biti više ili niže. Svakako preporučamo provjeru cijena i ponude s našim prodajnim savjetnicima.

Rokove isporuka artikala po narudžbi potrebno je provjeriti kod naših prodajnih savjetnika.

Cijene lagerskih artikala umanjene su za maksimalni popust neovisno o načinu plaćanja te se pored svakog lagerskog artikla nalazi oznaka lagera.

Sve navedene cijene u katalogu su s uračunatim PDV-om.

Cijene u eurima (EUR) računane su prema fiksnom tečaju konverzije 7,53450.

Slike proizvoda su ilustrativne prirode te ne moraju odgovarati stvarnom izgledu proizvoda.

Postoji mogućnost tiskarske pogreške.

PIKTOGRAMI:

🕒 Dostupno na lageru

🌟 Preporuka

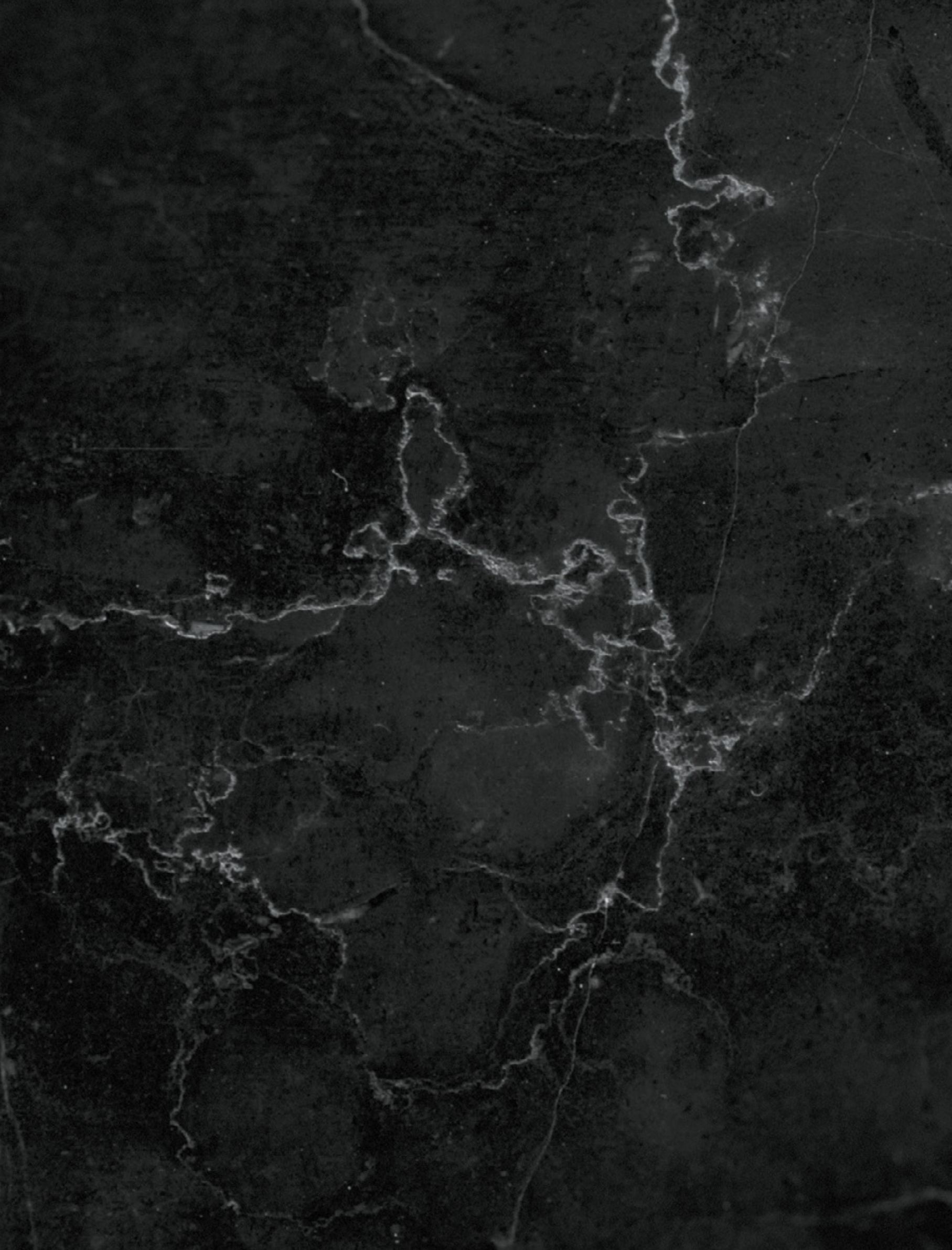



KERAMIČKE
PLOČICE

BLUSTYLE CONCRETE JUNGLE



BLUSTYLE Concrete Jungle | Factory 56 | 60x60 | Honed



Kolekcija je nadahnuta modernim gradovima, industrijskim prostorima i suvremenom arhitekturom.

Linija keramičkih podova u karakterističnim nijansama urbanog betona dolazi u tri boje i dvije završne obrade te je inovativnog dizajna.



Atelier 25

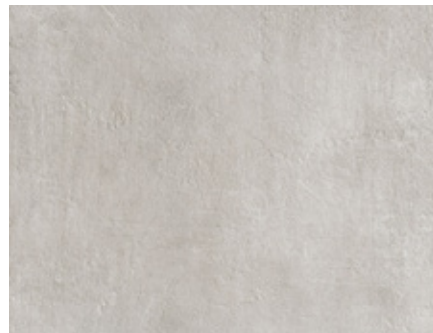

Factory 56

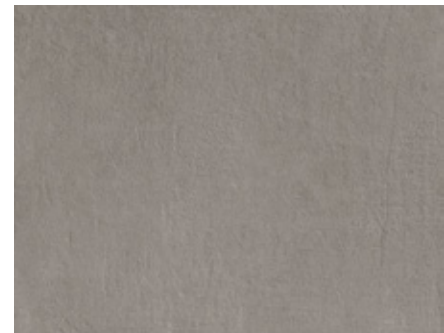

Store 18

BLUSTYLE CONCRETE JUNGLE

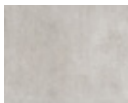
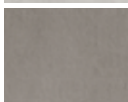
		30x60		60x60		90x90		60x60	Format (cm)
		9,5		9,5		9,5		20	Debljina (mm)
		Naturale	Honed	Naturale	Honed	Naturale	Honed	Grip	Završna obrada
		R10 B	R9	R10 B	R9	R10 B	R9	R11 C	Protukliznost
	Atelier 25	44,09	48,99	35,27	39,19	48,99	53,88	75,93	MPC (€/m ²)
		332,16	369,08	265,73	295,26	369,08	405,99	572,06	MPC (Kn/m ²)
		432643	432642	390316/Ⓛ	390317/Ⓛ	453918	453917	550605	Šif. / Dostupnost
	Factory 56	44,09	48,99	35,27	39,19	48,99	53,88	75,93	MPC (€/m ²)
		332,16	369,08	265,73	295,26	369,08	405,99	572,06	MPC (Kn/m ²)
		402753	402979	390321/Ⓛ	390322/Ⓛ	453920	453919	550611	Šif. / Dostupnost
	Store 18	44,09	48,99	44,09	48,99	48,99	53,88	75,93	MPC (€/m ²)
		332,16	369,08	332,16	369,08	369,08	405,99	572,06	MPC (Kn/m ²)
		453912	453911	453915	453916	453924	453923	550617	Šif. / Dostupnost



CAESAR JOIN



Pod CAESAR Join | Plume | 60x60 | Soft
Zid CAESAR Join | Verve Deco | 120x278

Prilikom narudžbe ploča velikih formata (120x278),
naplaćuje se paleta. Po povratu palete, vrši se povrat novca.

KERAMIČKE PLOČICE | BETON

Kolekcija kombinira modernost cementa s elegancijom smole u jednom proizvodu. Join pločice su vrhunske kvalitete, a površine su glatke te imaju svestrane uporabe.

Osim toga, Join se izdvaja po svojim izvanrednim tehničkim značajkama koje je čine savršenom za široku paletu primjena na podovima i zidovima, kako u zatvorenom tako i na otvorenom.

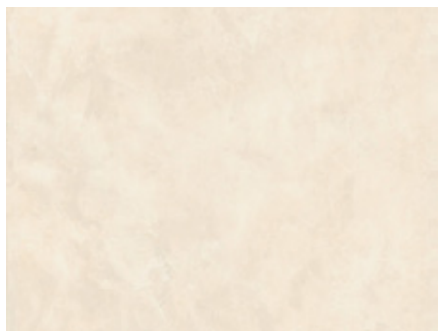

Candle

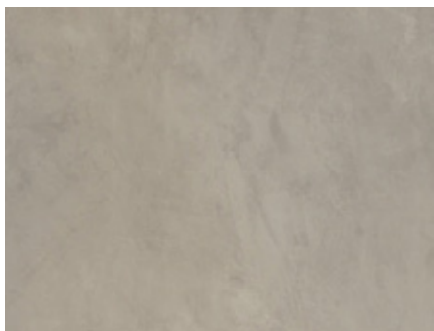

Wing

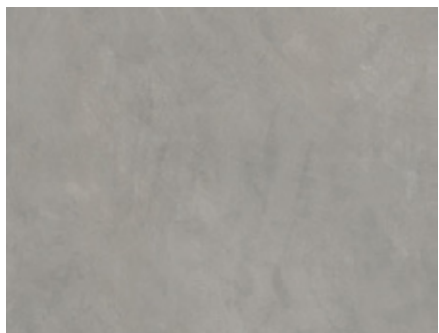

Levity

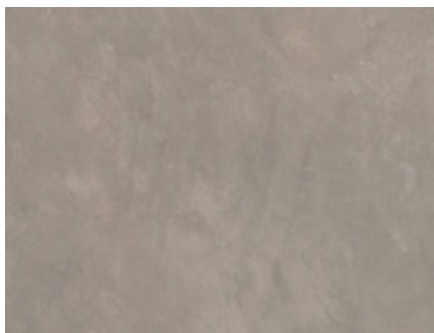

Manor



Pod CAESAR Join | Ink | 60x120 | Soft
Zid CAESAR Join | Spice Dusk | 120x278



Pod CAESAR Join | Levity | 120x120 | Naturale
Zid CAESAR Join | Levity | 60x120 | Soft; Ink | 60x120 / Soft



Plume



Glare

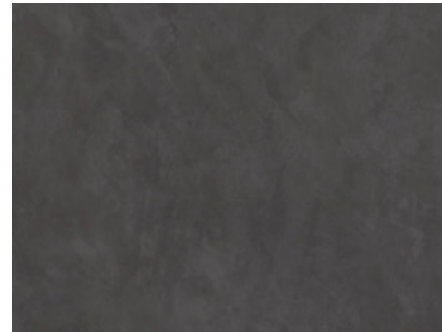

Chimney

CAESAR JOIN		30x60		60x60		60x120		Format (cm)
		9		9		9		Debljina (mm)
		Naturale	Soft	Naturale	Soft	Naturale	Soft	Završna obrada
		R10 B		R10 B		R10 B		Protukliznost
	Candle	40,25	40,25	45,41	45,41	38,00	38,00	MPC (€/m ²)
		303,24	303,24	342,14	342,14	286,28	286,27	MPC (Kn/m ²)
		828453	828426	828446	828416	828362/☼	828351/☼	Šif. / Dostupnost
	Wing	40,25	40,25	45,41	45,41	38,00	38,00	MPC (€/m ²)
		303,24	303,24	342,14	342,14	286,28	286,28	MPC (Kn/m ²)
		828451	828424	828444	828417	828359/☼	828352/☼	Šif. / Dostupnost
	Levity	40,25	40,25	45,41	45,41	38,00	38,00	MPC (€/m ²)
		303,24	303,24	342,14	342,14	286,28	286,28	MPC (Kn/m ²)
		828452	828425	828455	828414	828360/☼	828353/☼	Šif. / Dostupnost
	Manor	40,25	40,25	45,41	45,41	38,00	38,00	MPC (€/m ²)
		303,24	303,24	342,14	342,14	286,28	286,28	MPC (Kn/m ²)
		828454	828427	828447	828415	828361/☼	828354/☼	Šif. / Dostupnost
	Plume	40,25	40,25	45,41	45,41			MPC (€/m ²)
		303,24	303,24	342,14	342,14			MPC (Kn/m ²)
		828455	828428	828448	828418			Šif. / Dostupnost
	Glare	40,25	40,25	45,41	45,41	38,00	38,00	MPC (€/m ²)
		303,24	303,24	342,14	342,14	286,28	286,28	MPC (Kn/m ²)
		828456	828429	828449	828419	828363/☼	828355/☼	Šif. / Dostupnost
	Chimney	40,25	40,25	45,41	45,41			MPC (€/m ²)
		303,24	303,24	342,14	342,14			MPC (Kn/m ²)
		828457	828430	828450	828420			Šif. / Dostupnost
	Spice		50,84		45,41		45,41	MPC (€/m ²)
			383,04		342,14		342,14	MPC (Kn/m ²)
			828431		828421		828356/☼	Šif. / Dostupnost
	Verve		50,84		45,41		45,41	MPC (€/m ²)
			383,04		342,14		342,14	MPC (Kn/m ²)
			828432		828422		828357/☼	Šif. / Dostupnost
	Ink		50,84		45,41		45,41	MPC (€/m ²)
			383,04		342,14		342,14	MPC (Kn/m ²)
			828433		828423		828358/☼	Šif. / Dostupnost



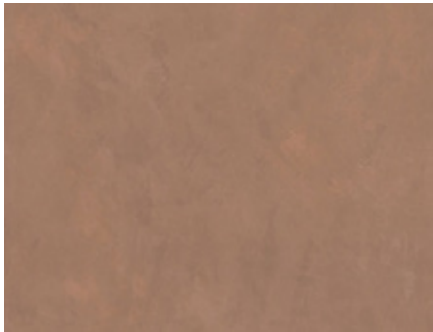



Spice

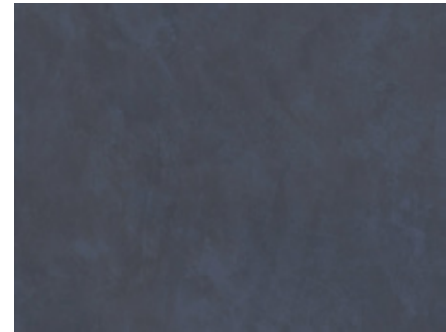

Verve

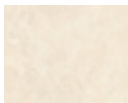
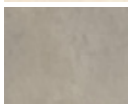
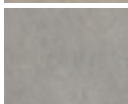
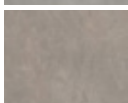

Ink

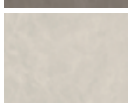
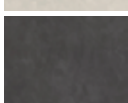
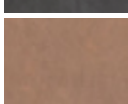
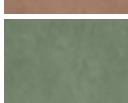
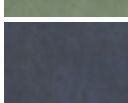
	80x80		120x120		120x278	60x60	Format (cm)
	9		9		6	20	Debljina (mm)
	Naturale	Soft	Naturale	Soft	Naturale	Strukturirana	Završna obrada
	R10 B		R10 B			R11 C	Protukliznost
	57,46	57,46	74,67	74,67			MPC (€/m ²)
	432,91	432,91	562,59	562,59			MPC (Kn/m ²)
	828440	828409	828464	828437			Šif. / Dostupnost
	57,46	57,46	74,67	74,67	98,50	71,76	MPC (€/m ²)
	432,91	432,91	562,59	562,59	742,14	540,65	MPC (Kn/m ²)
	828439	828410	828461	828434	828458	828488	Šif. / Dostupnost
	57,46	57,46	74,67	74,67	98,50	71,76	MPC (€/m ²)
	432,91	432,91	562,59	562,59	742,14	540,65	MPC (Kn/m ²)
	828441	828411	828462	828436	828459	828489	Šif. / Dostupnost
	57,46		74,67	74,67			MPC (€/m ²)
	432,91		562,59	562,59			MPC (Kn/m ²)
	828442		828463	828435			Šif. / Dostupnost
		57,46				71,76	MPC (€/m ²)
		432,91				540,65	MPC (Kn/m ²)
		828413				828490	Šif. / Dostupnost
	57,46		74,67	74,67	98,50		MPC (€/m ²)
	432,91		562,59	562,59	742,14		MPC (Kn/m ²)
	828443		828465	828438	828460		Šif. / Dostupnost
							MPC (€/m ²)
							MPC (Kn/m ²)
							Šif. / Dostupnost
							MPC (€/m ²)
							MPC (Kn/m ²)
							Šif. / Dostupnost
							MPC (€/m ²)
							MPC (Kn/m ²)
							Šif. / Dostupnost
							MPC (€/m ²)
							MPC (Kn/m ²)
							Šif. / Dostupnost

CAESAR MATERICA



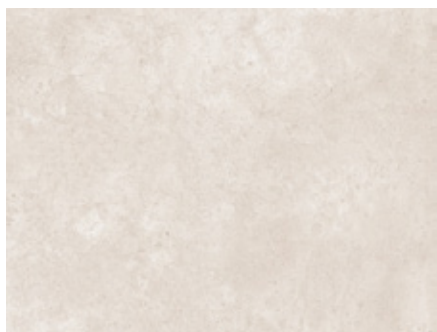

Bianco

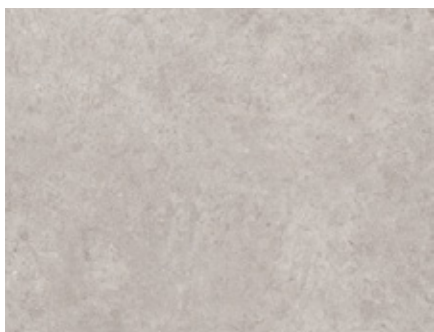

Grigio

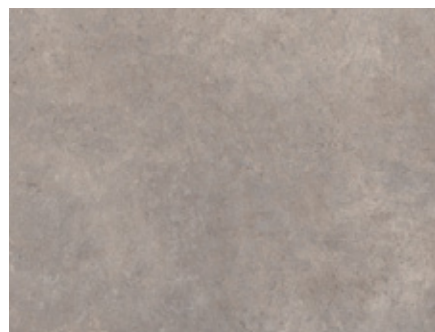

Polvere

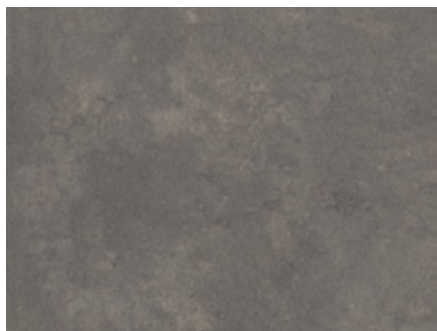

Antracite

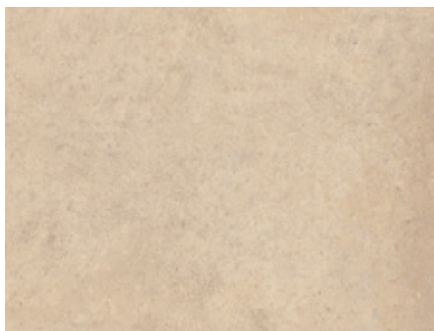

Corda

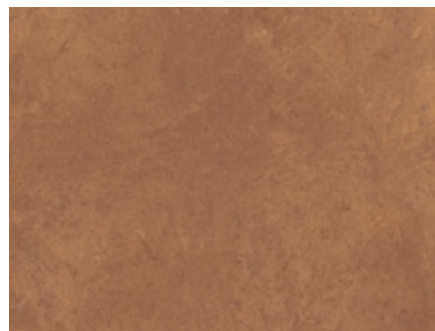

Terra

Materica prenosi na površinu pločice nesavršenosti u boji, što joj daje jedinstvenu umjetničku estetiku, dok tople i moderne boje pružaju urbani osjećaj.

Potpuno novi stil za prostore, bilo arhitektonske ili svakodnevne, nudi izbor boja za svačiji ukus.

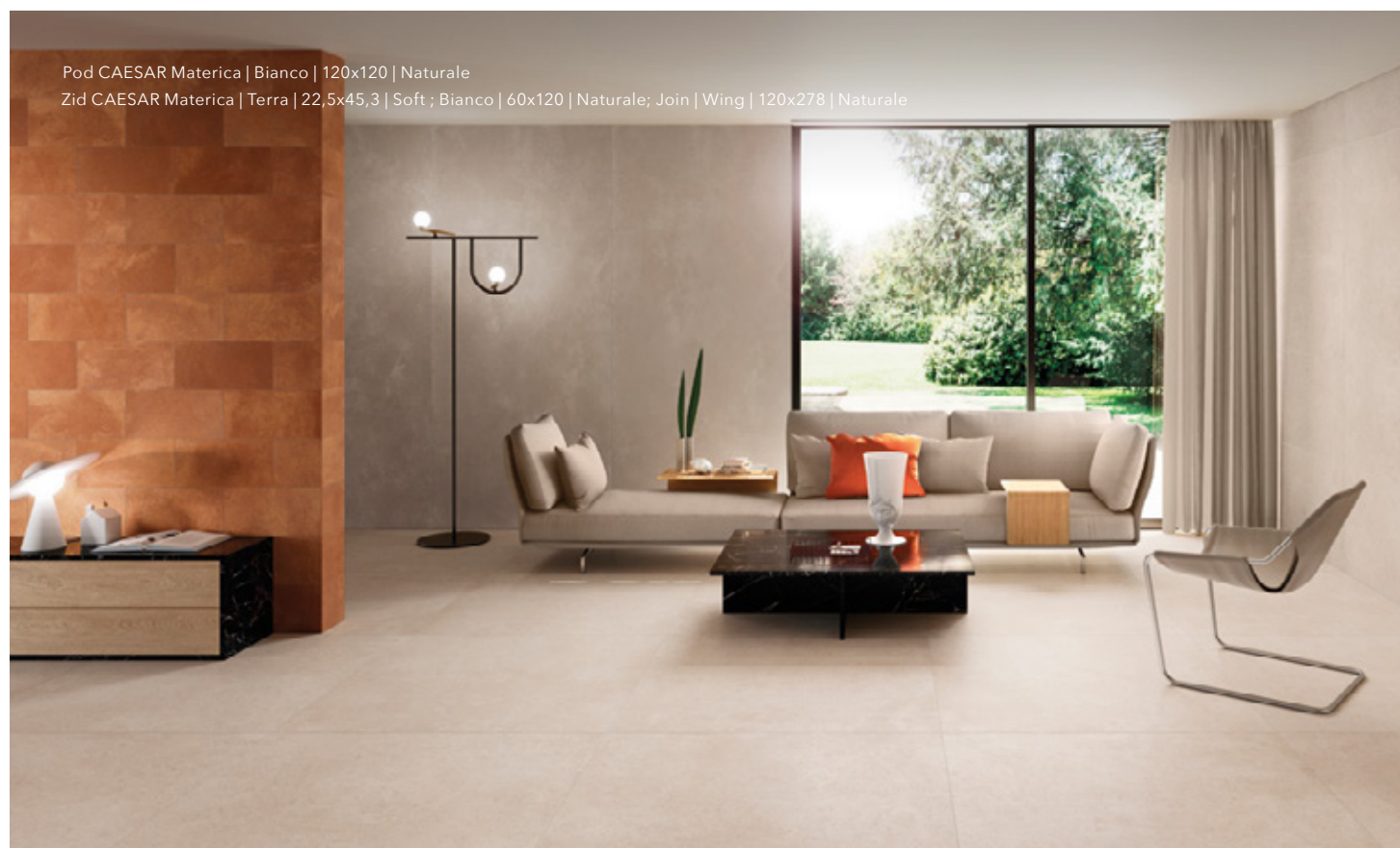









Pod CAESAR Materica | Corda | 80x80 | Naturale
Zid CAESAR Materica | Stile Corda/22,2x37 | Naturale; Meet | Allure Hazel | 20x120 | Naturale



Pod CAESAR Materica | Terra | 80x80 | Naturale; Corda | 80x80 | Strukturirana
Zid CAESAR Materica | Corda | 40x80

CAESAR MATERICA

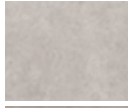
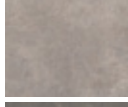
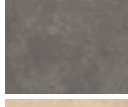
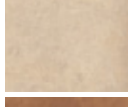
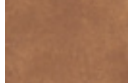
							
		40x80	80x80	60x120	120x120	80x80	Format (cm)
		9	9	9	9	20	Debljina (mm)
		Naturale	Naturale	Naturale	Naturale	Struktur.	Završna obrada
		R10 B	R10 B	R10 B	R10 B	R11 C	Protukliznost
	Bianco	59,97	57,46	38,00	74,67		MPC (€/m ²)
		451,86	432,91	286,29	562,59		MPC (Kn/m ²)
		887808	887795	887968/Ⓢ	886294		Šif. / Dostupnost
	Grigio	59,97	57,46	38,00	74,67		MPC (€/m ²)
		451,86	432,91	286,29	562,59		MPC (Kn/m ²)
		887810	887797	887970/Ⓢ	887838		Šif. / Dostupnost
	Polvere	59,97	57,46	38,00	74,67	83,80	MPC (€/m ²)
		451,86	432,91	286,29	562,59	631,41	MPC (Kn/m ²)
		887811	887798	887971/Ⓢ	887839	887069	Šif. / Dostupnost
	Antracite	59,97	57,46			83,80	MPC (€/m ²)
		451,86	432,91			631,41	MPC (Kn/m ²)
		887812	887799			887070	Šif. / Dostupnost
	Corda	59,97	57,46	38,00	74,67	83,80	MPC (€/m ²)
		451,86	432,91	286,29	562,59	631,41	MPC (Kn/m ²)
		887809	887796	887969/Ⓢ	887837	887068	Šif. / Dostupnost
	Terra	59,97	57,46				MPC (€/m ²)
		451,86	432,91				MPC (Kn/m ²)
		887814	886945				Šif. / Dostupnost

CAESAR ONE

Kolekcija porculanskih pločica ONE ima poseban cementni efekt koji je kombiniran s nježnim tonovima zemlje uz originalnost i modernost cementa.

Vašim interijerima ostavlja osjećaj topline, prirodnosti i elegancije koja ispunjava sve potrebe opremanja.

Ako volite toplinu i vintage izgled koji ova kolekcija sugerira, tada je ONE pravi odabir za vas.



CAESAR One | Cement | 60x60 | Naturale



Gesso



Rope



Cement

Prilikom narudžbe ploča velikih formata (120x278), naplaćuje se paleta. Po povratu palete, vrši se povrat novca.



Mud

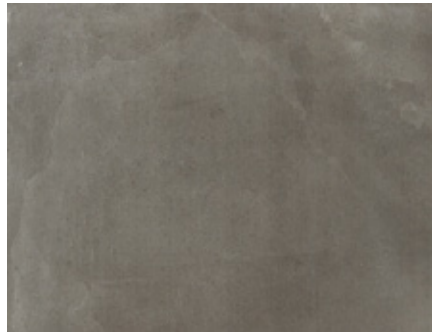

Ground

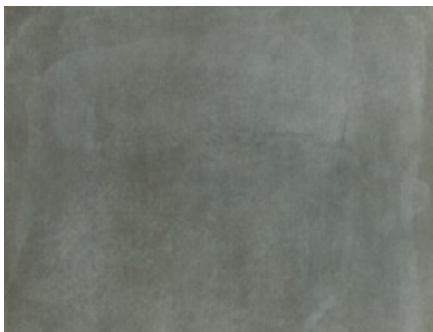

Indigo

















Mix Deco

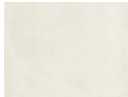

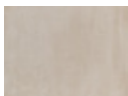
CAESAR One | Mix Deco | 30x30 | Naturale

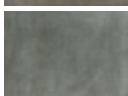
CAESAR ONE

											
		30x30	30x60	60x60		60x120	120x120	120x278	60x60		Format (cm)
		9	9	9		9	9	6	20		Debljina (mm)
		Naturale	Naturale	Naturale	Grip	Naturale	Naturale	Naturale	Grip		Završna obrada
		R10 A	R10 A	R10 A	R11 B	R10 A	R10 A	R10 A	R11 C	Protukliznost	
	Gesso		36,99	41,65	41,65	39,47	70,49			MPC (€/m ²)	
			278,70	313,81	313,81	297,40	531,08			MPC (Kn/m ²)	
			598202	598192	598196	368174/☆	457950			Šif. / Dostupnost	
	Rope		36,99	41,65	41,65				64,08	MPC (€/m ²)	
			278,70	313,81	313,81				482,79	MPC (Kn/m ²)	
			598200	597417	598194				401969	Šif. / Dostupnost	
	Cement		36,99	41,65	41,65	39,47	70,49	86,50	58,38	MPC (€/m ²)	
			278,70	313,81	313,81	297,40	531,08	651,76	439,86	MPC (Kn/m ²)	
			598199	597396	597924	368175/☆	457948	887902	401968	Šif. / Dostupnost	
	Mud		36,99	41,65	41,65					MPC (€/m ²)	
			278,70	313,81	313,81					MPC (Kn/m ²)	
			598201	598191	598195					Šif. / Dostupnost	
	Ground		36,99	41,65	41,65				64,08	MPC (€/m ²)	
			278,70	313,81	313,81				482,79	MPC (Kn/m ²)	
			598203	597909	598197				401970	Šif. / Dostupnost	
	Indigo		36,99	41,65	41,65					MPC (€/m ²)	
			278,70	313,81	313,81					MPC (Kn/m ²)	
			598204	598193	598198					Šif. / Dostupnost	
	Mix Deco		95,11		80,79					MPC (€/m ²)	
			716,60		608,68					MPC (Kn/m ²)	
			368212		598205					Šif. / Dostupnost	

CERAMICHEITALIANE

GENESIS

BLOK OUT



CERAMICHEITALIANE | Genesis | Blok Out Beige



Ice



Sand



Fog



Smoke



Blok Out White



Blok Out Beige













Blok Out Grey



Cementina Grey

Genesis kolekcija pronalazi inspiraciju u efektu cementa od koje su nastale četiri boje pločice. Dvije su boje u bež nijansama, a druge dvije u sivim nijansama. Boje su kompatibilne jedna s drugom te u sebi sadrže tople tonove pa se lako kombiniraju međusobno.

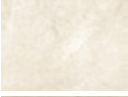
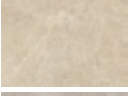
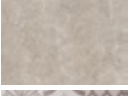
CERAMICHE ITALIANE
GENESIS
BLOK OUT

							Format (cm)	
		20x20	30x60		60x60	60x120	60x60	Debljina (mm)
		8,5	9,5	9,5	9,5	10	20	Završna obrada
		Naturale	Naturale	Grip	Naturale	Naturale	Grip	Protukliznost
		R9	R9	R11 Neret.	R9	R10	R11	MPC (€/m ²)
	Ice		29,13		29,13	36,12		MPC (€/m ²)
			219,45		219,45	272,12		MPC (Kn/m ²)
			611812/Ⓛ		611808/Ⓛ	584607/Ⓛ		Šif. / Dostupnost
	Sand		29,13		29,13	36,12	58,25	MPC (€/m ²)
			219,45		219,45	272,12	438,90	MPC (Kn/m ²)
			611814/Ⓛ		611810/Ⓛ	584608/Ⓛ	603403/Ⓛ	Šif. / Dostupnost
	Fog		29,13		29,13	36,12	58,25	MPC (€/m ²)
			219,45		219,45	272,12	438,90	MPC (Kn/m ²)
			611813/Ⓛ		611809/Ⓛ	550405/Ⓛ	603404/Ⓛ	Šif. / Dostupnost
	Smoke		29,13		29,13	36,12		MPC (€/m ²)
			219,45		219,45	272,12		MPC (Kn/m ²)
			611815/Ⓛ		611811/Ⓛ	584609/Ⓛ		Šif. / Dostupnost
	Blok Out White			25,63			58,25	MPC (€/m ²)
				193,12			438,90	MPC (Kn/m ²)
				830409/Ⓛ			966165/Ⓛ	Šif. / Dostupnost
	Blok Out Beige			25,63			58,25	MPC (€/m ²)
				193,12			438,90	MPC (Kn/m ²)
				830410/Ⓛ			966166/Ⓛ	Šif. / Dostupnost
	Blok Out Grey			25,63				MPC (€/m ²)
				193,12				MPC (Kn/m ²)
				830411/Ⓛ				Šif. / Dostupnost
	Cementina Grey		20,90					MPC (€/m ²)
			157,50					MPC (Kn/m ²)
			612182/Ⓛ					Šif. / Dostupnost

CERAMICHEITALIANE **MATERIKA**





CERAMICHEITALIANE | Materika | Sand | 60x120 | Naturale

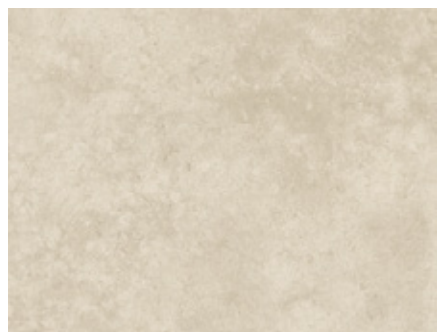

Sand

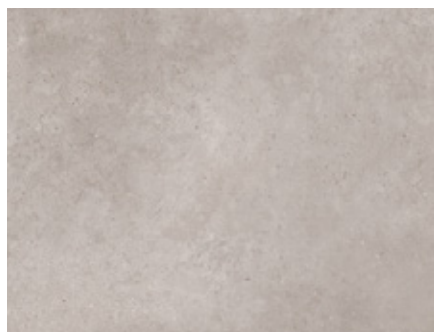





Silver

Šarmantna kolekcija Materika vraća prirodne tonove u vaš dom.

Kolekcija je pogodna za sve prostorije radi svoje jednostavnosti.

CERAMICHE ITALIANE MATERIKA

					
		30x60	60x60	60x120	Format (cm)
		9,5	9,5	10	Debljina (mm)
		Naturale	Naturale	Naturale	Završna obrada
		R10	R10	R10	Protukliznost
	Sand	29,13	29,13	36,12	MPC (€/m ²)
		219,45	219,45	272,12	MPC (Kn/m ²)
		966172/Ⓛ	966169/Ⓛ	966167/Ⓛ	Šif. / Dostupnost
	Silver	29,13	29,13	36,12	MPC (€/m ²)
		219,45	219,45	272,12	MPC (Kn/m ²)
		966171/Ⓛ	966170/Ⓛ	966168/Ⓛ	Šif. / Dostupnost

CERAMICHEITALIANE **MORE**





Ice



Ivory



Taupe

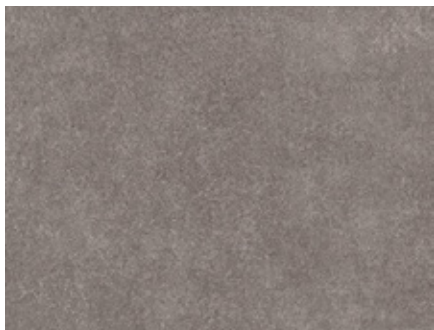

Dark







CEARAMCHEITALIANE More | Grey | 60x120 | Naturale



Grey

Diskretna, moderna kolekcija More pristaje gotovo svakom interijeru, a ponajviše onom koji sadržava dašak industrijskog stila. Pločice imitiraju efekte kakvi se viđaju na betonu, a osim sive, mogu se dobiti i u zemljanim tonovima.

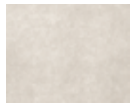
CERAMICHE ITALIANE MORE

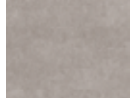
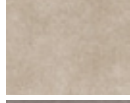
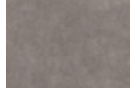
					
		30x60	60x60	60x120	Format (cm)
		9,5	9,5	10	Debljina (mm)
		Naturale	Naturale	Naturale	Završna obrada
		R10	R10	R10	Protukliznost
	Ice	29,13	29,13	36,12	MPC (€/m ²)
		219,45	219,45	272,12	MPC (Kn/m ²)
		612168/Ⓛ	612163/Ⓛ	828146/Ⓛ	Šif. / Dostupnost
	Ivory	29,13	29,13	36,12	MPC (€/m ²)
		219,45	219,45	272,12	MPC (Kn/m ²)
		612169/Ⓛ	612164/Ⓛ	966145/Ⓛ	Šif. / Dostupnost
	Grey	29,13	29,13	36,12	MPC (€/m ²)
		219,45	219,45	272,12	MPC (Kn/m ²)
		612170/Ⓛ	612165/Ⓛ	966146/Ⓛ	Šif. / Dostupnost
	Taupe	29,13	29,13	36,12	MPC (€/m ²)
		219,45	219,45	272,12	MPC (Kn/m ²)
		612171/Ⓛ	612166/Ⓛ	966147/Ⓛ	Šif. / Dostupnost
	Dark	29,13	29,13	36,12	MPC (€/m ²)
		219,45	219,45	272,12	MPC (Kn/m ²)
		612172/Ⓛ	612167/Ⓛ	828145/Ⓛ	Šif. / Dostupnost

CERIM MAPS

Maps of Cerim je kolekcija iz tvornice Florim koja objedinjuje sive boje i čiste, svijetle linije industrijskog cementa. Cerimove pločice prostorima daju kreativnost te su zamišljene gotovo kao ukras svakog kućnog okruženja.

Za svačiji stil i osobnost u velikom izboru formata, obrada i debljine, Cerim Maps nikoga neće razočarati.



CERIM Maps | Light Gray | 60x120 | Naturale

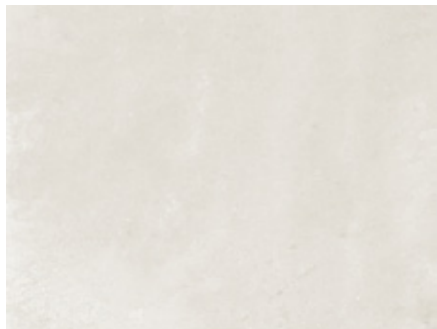

White



Beige

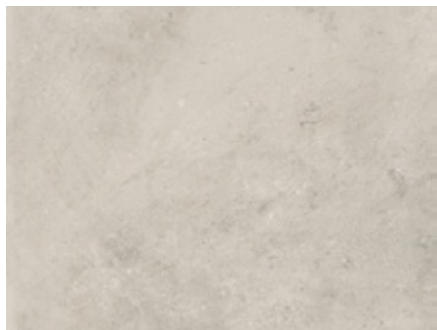

Light Gray

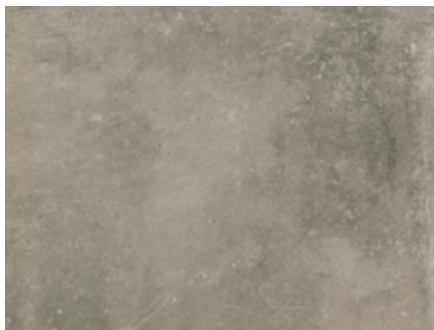

Dark Gray

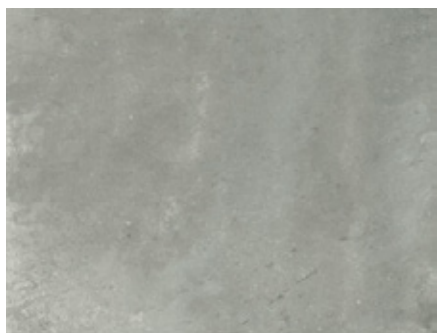







Graphite



CERIM Maps | Graphite | 60x60 | Naturale

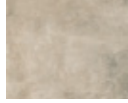
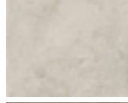
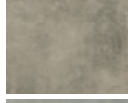
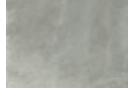

CERIM MAPS

							Format (cm)	
		30x60	60x60	60x120	80x80	60x60	Format (cm)	
		9	9	9	9	20	Debljina (mm)	
		Naturale	Bocciardato	Naturale	Naturale	Naturale	Bocciardato	Završna obrada
		R10 A	R11 C	R10 A	R10 A	R10 A	R11 B	Protukliznost
	White	39,33	39,33	42,89	60,64	60,64		MPC (€/m ²)
		296,33	296,33	323,13	456,87	456,87		MPC (Kn/m ²)
		437709	437704	437699	437687	494490		Šif. / Dostupnost
	Beige	39,33	39,33	42,89	60,64	60,64	61,60	MPC (€/m ²)
		296,33	296,33	323,13	456,87	456,87	464,15	MPC (Kn/m ²)
		437710	437705	437700	437688	494491	437714	Šif. / Dostupnost
	Light Gray	39,33	39,33	42,89	60,64	60,64	61,60	MPC (€/m ²)
		296,33	296,33	323,13	456,87	456,87	464,15	MPC (Kn/m ²)
		437711	437706	437701	437689	494493	437715	Šif. / Dostupnost
	Dark Gray	39,33	39,33	42,89	60,64	60,64		MPC (€/m ²)
		296,33	296,33	323,13	456,87	456,87		MPC (Kn/m ²)
		437712	437707	437702	437690	494492		Šif. / Dostupnost
	Graphite	39,33	39,33	42,89	60,64	60,64		MPC (€/m ²)
		296,33	296,33	323,13	456,87	456,87		MPC (Kn/m ²)
		437713	437708	437703	437691	494494		Šif. / Dostupnost

COTTO D'ESTE

X-BETON

X-Beton donosi površinu nadahnutu valjanim cementom. Tekstura i boje su u savršenom skladu s trendovima moderne arhitekture. Radi se o stilu koji oslobađa prostor, ali mu daje osobit pečat a pritom zadržava eleganciju i profinjenost.

X-Beton pločice su s karakterom.





DOT-30



DOT-50

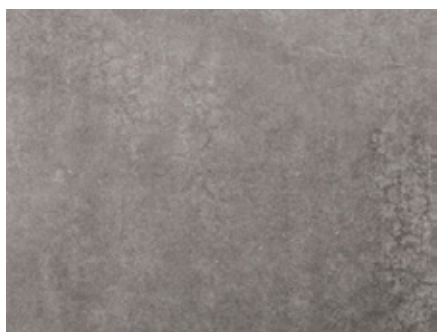

DOT-70



COTTO D'ESTE X-Beton | DOT-50 | 60x120 | Satinata

COTTO D'ESTE X-BETON

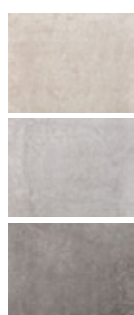

		60x60		60x120		90x90		90x90	Format (cm)
		14		14		14		20	Debljina (mm)
		Naturale	Satinata	Naturale	Satinata	Naturale	Satinata	Naturale	Završna obrada
		R11 C	R10 C	R11 C	R10 C	R11 C	R10 C	R11 C	Protukliznost
DOT-30		62,46	67,60	52,90	71,03	66,13	71,03	85,72	MPC (€/m ²)
		470,58	509,33	398,60	535,16	498,25	535,16	645,89	MPC (Kn/m ²)
		390613	434532	390612/Ⓢ	434535	390611	435562	604388	Šif. / Dostupnost
DOT-50		62,46	67,60	52,90	71,03	66,13	71,03	85,72	MPC (€/m ²)
		470,58	509,33	398,60	535,16	498,25	535,16	645,89	MPC (Kn/m ²)
		390621	434533	390620/Ⓢ	434536	390619	455571	603367	Šif. / Dostupnost
DOT-70		62,46	67,60	66,13	71,03	66,13	71,03	85,72	MPC (€/m ²)
		470,58	509,33	498,25	535,16	498,25	535,16	645,89	MPC (Kn/m ²)
		390629	434534	390628	434537	390627	455572	604389	Šif. / Dostupnost



FLOOR GRES INDUSTRIAL

Industrial kolekcija iz Floor Gresa se ističe širokim rasponom boja, modularnim veličinama, opcijama debljine te završne obrade. Ove pločice atraktivne su u bilo kojem arhitektonskom kontekstu. Također, inovativne veličine dizajna Magnum Oversize omogućavaju vam potpuno novu ideju o prostoru.

Moderna jednostavnost dvije su riječi koje najbolje opisuju ovu kolekciju.



Pod FLOOR GRES Industrial | Moka | 120x240 | Naturale
Zid LOOR GRES Industrial | Ivory | 120x240 | Naturale
Dekor A+B Taupe/Ivory 30x30

Prilikom narudžbe ploča velikih formata (160x160, 120x240, 120x280, 160x320), naplaćuje se paleta. Po povratu palete, vrši se povrat novca.

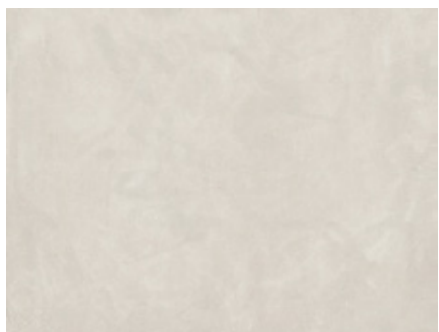

Ivory

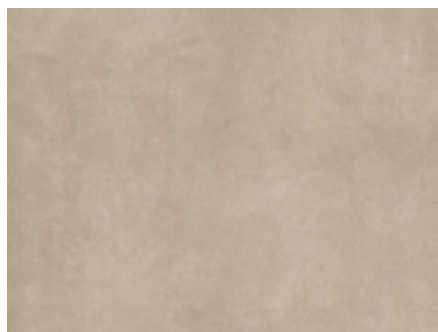

Taupe



Moka

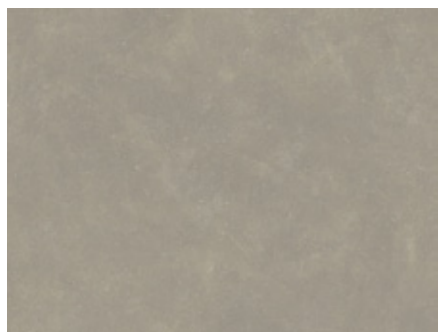

Sage

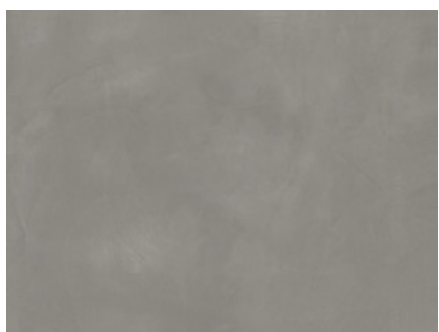

Steel

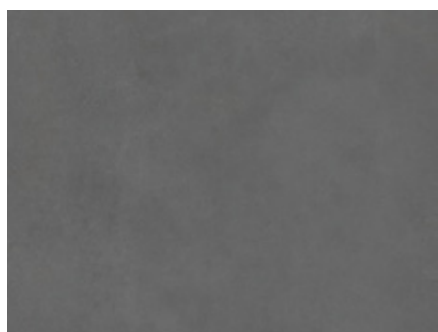

Plomb



Pod FLOOR GRES Industrial | Moka | 120x240 | Naturale
Zid FLOOR GRES Industrial | Ivory | 120x240 | Naturale













FLOOR GRES Industrial | Steel | 60x60 | Soft











FLOOR GRES Industrial | Steel | 80x80 | Naturale

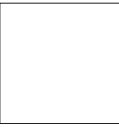
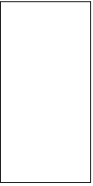

FLOOR GRES INDUSTRIAL

		 30x60			 60x60		 60x120		 40x80		Format (cm)
		9			9		9		9		Debljina (mm)
		Naturale	Soft	Bocciar.	Naturale	Soft	Naturale	Soft	Naturale	Soft	Završna obrada
		R10 B	R9 A	R11 C	R10 B	R9 A	R10 B	R9 A	R10 B	R9 A	Protukliznost
	Ivory	43,58	44,72	44,72	47,74	52,89	74,80	78,36	50,96	50,96	MPC (€/m ²)
		328,34	336,98	336,98	359,70	398,53	563,60	590,39	383,98	383,98	MPC (Kn/m ²)
		323096	323102	323108	323084	323090	323036	323042	323060	323066	Šif. / Dostupnost
	Taupe	43,58	44,72	44,72	47,74	52,89	74,80	78,36	50,96	50,96	MPC (€/m ²)
		328,34	336,98	336,98	359,70	398,53	563,60	590,39	383,98	383,98	MPC (Kn/m ²)
		323097	323103	323109	323085	323091	323037	323043	323061	323067	Šif. / Dostupnost
	Moka	43,58	44,72	44,72	47,74	52,89	74,80	78,36	50,96	50,96	MPC (€/m ²)
		328,34	336,98	336,98	359,70	398,53	563,60	590,39	383,98	383,98	MPC (Kn/m ²)
		323098	323104	323110	323086	323092	323038	323044	323062	323068	Šif. / Dostupnost
	Sage	43,58	44,72	44,72	47,74	52,89	74,80	78,36	50,96	50,96	MPC (€/m ²)
		328,34	336,98	336,98	359,70	398,53	563,60	590,39	383,98	383,98	MPC (Kn/m ²)
		323099	323105	323111	323087	323093	323039	323045	323063	323069	Šif. / Dostupnost
	Steel	43,58	44,72	44,72	47,74	52,89	74,80	78,36	50,96	50,96	MPC (€/m ²)
		328,34	336,98	336,98	359,70	398,53	563,60	590,39	383,98	383,98	MPC (Kn/m ²)
		323100	323106	323112	323088	323094	323040	323046	323064	323070	Šif. / Dostupnost
	Plomb	43,58	44,72	44,72	47,74	52,89	74,80	78,36	50,96	50,96	MPC (€/m ²)
		328,34	336,98	336,98	359,70	398,53	563,60	590,39	383,98	383,98	MPC (Kn/m ²)
		323101	323107	323113	323089	323095	323041	323047	323065	323071	Šif. / Dostupnost

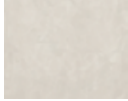
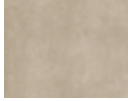
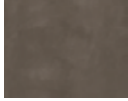
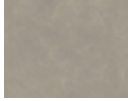
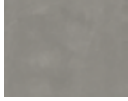
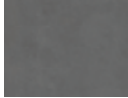
										Format (cm)	
	80x80	60x120	80x80	120x120	160x160	120x240	120x280	160x320	60x60	Format (cm)	
	9	6	6	6	6	6	6	6	20	Debljina (mm)	
	Naturale	Soft	Naturale	Naturale	Naturale	Naturale	Naturale	Naturale	Bocciar.	Završna obrada	
	R10 B	R9 A	R9	R9	R9	R9	R9	R9	R11 C	Protukliznost	
	71,58	74,80	80,17	73,42	96,11	124,17	118,69	125,13	152,44	97,04	MPC (€/m ²)
	539,30	563,60	604,02	553,15	724,14	935,55	894,23	942,82	1.148,53	731,17	MPC (Kn/m ²)
	323048	323054	435990	435998	435979	435962	435969	548199	435956	323114	Šif. / Dostupnost
	71,58	74,80	80,17	73,42	96,11	124,17	118,69	125,13	152,44	97,04	MPC (€/m ²)
	539,30	563,60	604,02	553,15	724,14	935,55	894,23	942,82	1.148,53	731,17	MPC (Kn/m ²)
	323049	323055	435986	436002	435980	435966	435967	548200	435957	323115	Šif. / Dostupnost
	71,58	74,80	80,17	73,42	96,11	124,17	118,69	125,13	152,44	97,04	MPC (€/m ²)
	539,30	563,60	604,02	553,15	724,14	935,55	894,23	942,82	1.148,53	731,17	MPC (Kn/m ²)
	323050	323056	435989	435997	435981	435963	435968	548201	435958	323116	Šif. / Dostupnost
	71,58	74,80	80,17	73,42	96,11	124,17	118,69	125,13	152,44	97,04	MPC (€/m ²)
	539,30	563,60	604,02	553,15	724,14	935,55	894,23	942,82	1.148,53	731,17	MPC (Kn/m ²)
	323051	323057	435987	436000	435984	435961	574604	548202	435960	323117	Šif. / Dostupnost
	71,58	74,80	80,17	73,42	96,11	124,17	118,69	125,13	152,44	97,04	MPC (€/m ²)
	539,30	563,60	604,02	553,15	724,14	935,55	894,23	942,82	1.148,53	731,17	MPC (Kn/m ²)
	323052	323058	435985	435999	435983	435964	435971	548203	435959	323118	Šif. / Dostupnost
	71,58	74,80	80,17	73,42	96,11	124,17	118,69	125,13	152,44	97,04	MPC (€/m ²)
	539,30	563,60	604,02	553,15	724,14	935,55	894,23	942,82	1.148,53	731,17	MPC (Kn/m ²)
	323053	323059	435988	436001	435982	435965	435972	548204	435955	323119	Šif. / Dostupnost

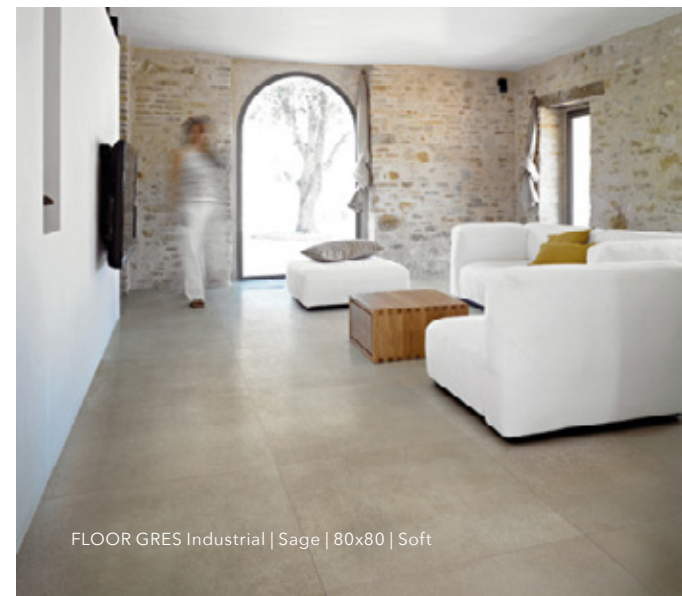

IMOLA AZUMA

Na temelju materijala koji sačinjavaju beton, Imola je ponudila pet boja pločica unutar kolekcije Azuma. Inovativne pločice imaju dašak vintage stila radi nježnih mrlja na površini.

Neka vam Azuma posluži kao izvor inspiracije za uređenje vašeg prostora, a širok spektar formata pomoći će vam pri tome.



Pod IMOLA Azuma | AG | 120x120 | Naturale
Zid IMOLA Azuma | AG | 60x120, 120x260 | Naturale

Prilikom narudžbe ploča velikih formata (120x260), naplaćuje se paleta za koju se ne vrši povrat novca.

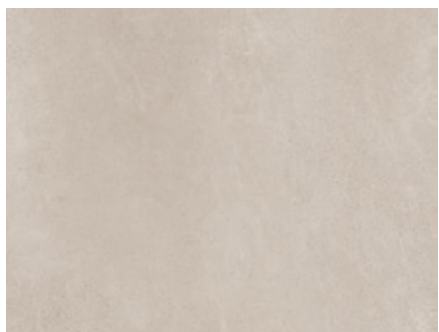

CG

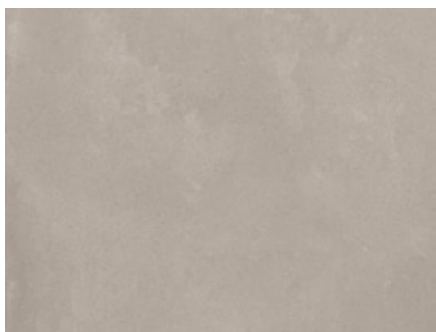

AG

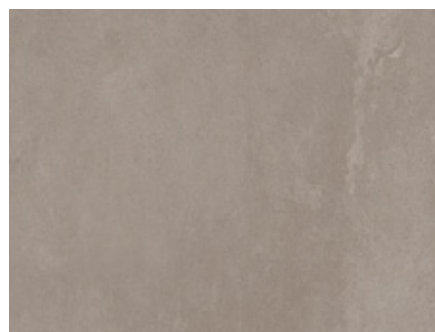

G



DG

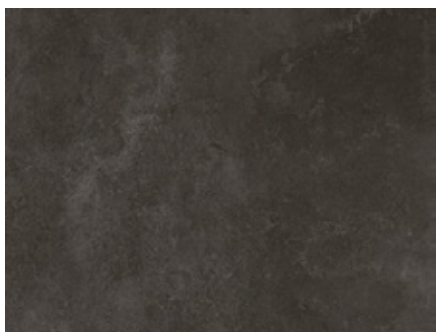









N







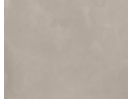
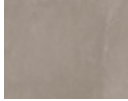

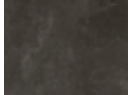



Pod IMOLA Azuma | AG | 60x120, 120x120 | Naturale
Zid IMOLA Azuma | AG | 120x260 | Naturale

IMOLA AZUMA

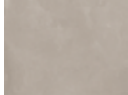
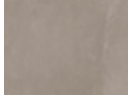
								
		30x60	60x60	60x120	45x90	90x90	Format (cm)	
		10	10	10	10	10	Debljina (mm)	
		Naturale	Naturale	Naturale	Grip	Naturale	Naturale	Završna obrada
		R10 A	R10 A	R10 A	R11 C	R10 A	R10 A	Protukliznost
	CG	47,98	47,29	54,73	57,64	50,52	54,73	MPC (€/m ²)
		361,50	356,31	412,36	434,31	380,65	412,36	MPC (Kn/m ²)
		551622	551607	551597	551602	551612	551592	Šif. / Dostupnost
	AG	47,98	47,29	54,73	57,64	50,52	54,73	MPC (€/m ²)
		361,50	356,31	412,36	434,31	380,65	412,36	MPC (Kn/m ²)
		551621	551606	551596	551601	551611	551591	Šif. / Dostupnost
	G	47,98	47,29	54,73	57,64	50,52	54,73	MPC (€/m ²)
		361,50	356,31	412,36	434,31	380,65	412,36	MPC (Kn/m ²)
		551624	551609	551599	551604	551614	551594	Šif. / Dostupnost
	DG	47,98	47,29	54,73	57,64	50,52	54,73	MPC (€/m ²)
		361,50	356,31	412,36	434,31	380,65	412,36	MPC (Kn/m ²)
		551623	551608	551598	551603	551613	551593	Šif. / Dostupnost
	N	47,98	47,29	54,73	57,64	50,52	54,73	MPC (€/m ²)
		361,50	356,31	412,36	434,31	380,65	412,36	MPC (Kn/m ²)
		551625	551610	551600	551605	551615	551595	Šif. / Dostupnost

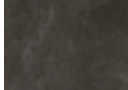
							Format (cm)
	120x120	60x120	120x120	120x260	60x60	90x90	Format (cm)
	10	6,5	6,5	6,5	20	20	Debljina (mm)
	Naturale	Naturale	Naturale	Naturale	Grip	Grip	Završna obrada
	R10 A	R10 A	R10 A	R10 A	R11 C	R11 C	Protukliznost
	72,76	55,60	71,44	99,98	67,62	92,20	MPC (€/m ²)
	548,23	418,95	538,25	753,31	509,53	694,66	MPC (Kn/m ²)
	551582	847243	551587	551577	847247	847239	Šif. / Dostupnost
	72,76	55,60	71,44	99,98			MPC (€/m ²)
	548,23	418,95	538,25	753,31			MPC (Kn/m ²)
	551581	847242	551586	551576			Šif. / Dostupnost
	72,76	55,60	71,44	99,98	67,62	92,20	MPC (€/m ²)
	548,23	418,95	538,25	753,31	509,53	694,66	MPC (Kn/m ²)
	551584	847245	551589	551579	847249	847241	Šif. / Dostupnost
	72,76	55,60	71,44	99,98	67,62	92,20	MPC (€/m ²)
	548,23	418,95	538,25	753,31	509,53	694,66	MPC (Kn/m ²)
	551583	847244	551588	551578	847248	847240	Šif. / Dostupnost
	72,76	55,60	71,44	99,98			MPC (€/m ²)
	548,23	418,95	538,25	753,31			MPC (Kn/m ²)
	551585	847246	551590	551580			Šif. / Dostupnost



Pod IMOLA Azuma | CG | 60x120 | Naturale
 Zid IMOLA Azuma | Dekor | DG | 120x260 | Naturale

IMOLA

AZUMA UP

Azuma Up nastavak je popularne Imoline kolekcije Azuma. Kolekcija koja, iako imitira površinu betona, ostavlja dojam prirode radi divnih sivih i zemljanih tonova od kojih je napravljena.

Nježna, a opet sa čvrstim karakterom, Azuma Up unosi svojevrsan apstraktni minimalizam. Za razliku od Azume, Azuma Up poprimila je mekše nijanse poput slonovače te boje lješnjaka.



IMOLA Azuma Up | AV | 120x120 | Natural



W

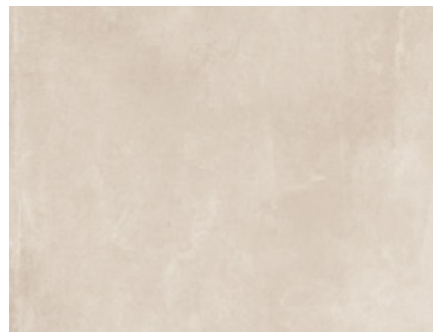

AV

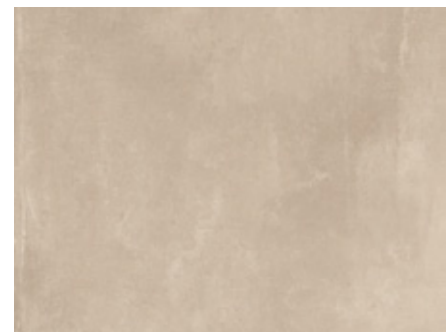

S

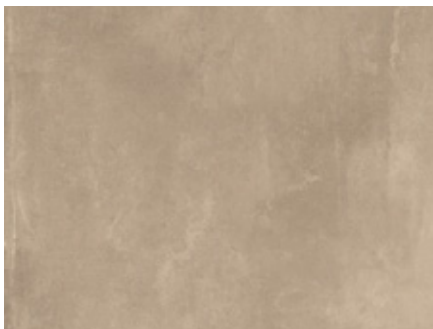

NO

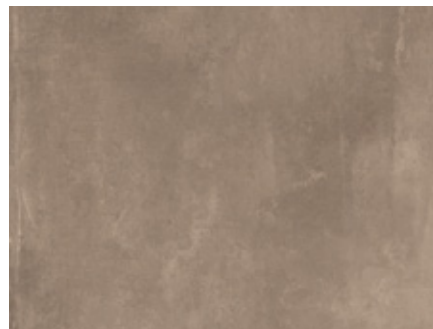













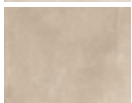
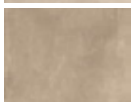
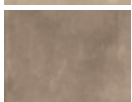

TP

Prilikom narudžbe ploča velikih formata (120x260), naplaćuje se paleta za koju se ne vrši povrat novca.

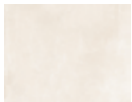
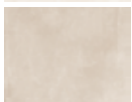
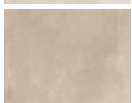
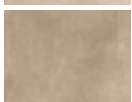

**IMOLA
AZUMA UP**

						Format (cm)	
		30x60	60x60	90x90	60x120	Format (cm)	
		10	10	10	10	Debljina (mm)	
		Naturale	Naturale	Naturale	Naturale	Grip	Završna obrada
		R10 A	R10 A	R10 A	R10 A	R11 C	Protukliznost
	W	47,98	47,29	54,73	54,73	57,64	MPC (€/m ²)
		361,50	356,31	412,36	412,36	434,31	MPC (Kn/m ²)
		991960	991952	991934	991942	991947	Šif. / Dostupnost
	AV	47,98	47,29	54,73	54,73	57,64	MPC (€/m ²)
		361,50	356,31	412,36	412,36	434,31	MPC (Kn/m ²)
		991956	991948	991930	991938	991943	Šif. / Dostupnost
	S	47,98	47,29	54,73	54,73	57,64	MPC (€/m ²)
		361,50	356,31	412,36	412,36	434,31	MPC (Kn/m ²)
		991958	991950	991932	991940	991945	Šif. / Dostupnost
	NO	47,98	47,29	54,73	54,73	57,64	MPC (€/m ²)
		361,50	356,31	412,36	412,36	434,31	MPC (Kn/m ²)
		991957	991949	991931	991968	991944	Šif. / Dostupnost
	TP	47,98	47,29	54,73	54,73	57,64	MPC (€/m ²)
		361,50	356,31	412,36	412,36	434,31	MPC (Kn/m ²)
		991959	991951	991933	991941	991946	Šif. / Dostupnost

								Format (cm)
		120x120	60x120	120x120	120x260	60x60	90x90	Format (cm)
		10	6,5	6,5	6,5	20	20	Debljina (mm)
		Naturale	Naturale	Naturale	Naturale	Grip	Grip	Završna obrada
		R10 A	R10 A	R10 A	R10 A	R11 C	R11 C	Protukliznost
		72,76	55,60	71,44	99,98			MPC (€/m ²)
		548,23	418,95	538,25	753,31			MPC (Kn/m ²)
		991929	994360	994355	991924			Šif. / Dostupnost
		694,66	55,60	71,44	99,98	67,63	92,20	MPC (€/m ²)
		548,23	418,95	538,25	753,31	509,53	694,66	MPC (Kn/m ²)
		008338	994356	994351	991920	991953	991935	Šif. / Dostupnost
		694,66	55,60	71,44	99,98	67,63	92,20	MPC (€/m ²)
		548,23	418,95	538,25	753,31	509,53	694,66	MPC (Kn/m ²)
		991927	994358	994353	991922	991955	991937	Šif. / Dostupnost
		694,66	55,60	71,44	99,98	67,63	92,20	MPC (€/m ²)
		548,23	418,95	538,25	753,31	509,53	694,66	MPC (Kn/m ²)
		991926	994357	994352	991921	991954	991936	Šif. / Dostupnost
		694,66	55,60	71,44	99,98			MPC (€/m ²)
		548,23	418,95	538,25	753,31			MPC (Kn/m ²)
		991928	994359	994354	991923			Šif. / Dostupnost

IMOLA BLOX

Mljevene sedimentne stijene i glina pomiješani s pijeskom i vodom tvore kompaktnu ljepljivu tvar koja se koristi u građevinskoj industriji za spajanje cigle, kamena te blokova.

Upravo iz spajanja ovih građevinskih materijala dolazi inspiracija za kolekciju Blox koju je moguće dobiti u šest različitih boja i pet formata.



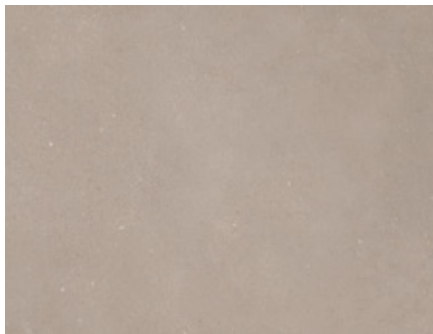

B



W

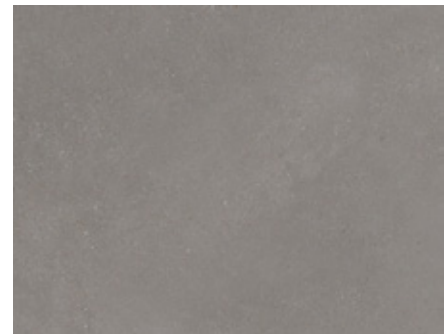

G



BS

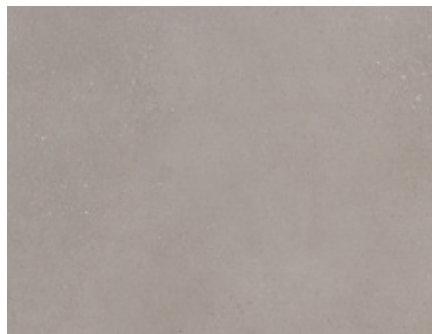



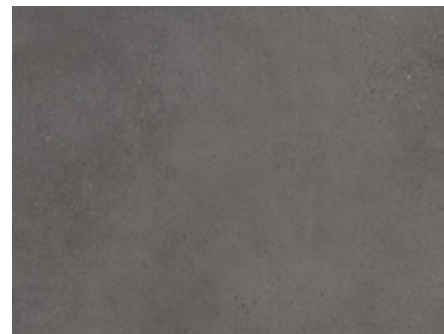









AG

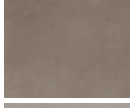
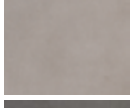

DG

IMOLA
BLOX

										
		30x60	60x60		90x90	60x120	120x120	60x60	90x90	Format (cm)
		10	10		10	6,5	6,5	20	20	Debljina (mm)
		Naturale	Naturale	Grip	Naturale	Naturale	Naturale	Grip	Grip	Završna obrada
		R10 B	R10 B	R11 C	R10 B	R10 B	R10 B	R11 C	R11 C	Protukliznost
	B	43,19	47,29	50,41	54,73	55,60	71,44	67,66	92,20	MPC (€/m ²)
		325,39	356,31	379,85	412,36	418,95	538,25	509,53	694,66	MPC (Kn/m ²)
		868590	868570	868579	868554	868563	868549	868575	868559	Šif. / Dostupnost
	W	43,19	47,29	50,41	54,73	55,60	71,44			MPC (€/m ²)
		325,39	356,31	379,85	412,36	418,95	538,25			MPC (Kn/m ²)
		868594	866929	868582	859298	866928	868359			Šif. / Dostupnost
	G	43,19	47,29	50,41	54,73	55,60	71,44	67,66	92,20	MPC (€/m ²)
		325,39	356,31	379,85	412,36	418,95	538,25	509,53	694,66	MPC (Kn/m ²)
		868593	868573	868581	868557	868566	868552	868577	868561	Šif. / Dostupnost
	BS	43,19	47,29	50,41	54,73	55,60	71,44	67,66	92,20	MPC (€/m ²)
		325,39	356,31	379,85	412,36	418,95	538,25	509,53	694,66	MPC (Kn/m ²)
		868591	868571	868580	868555	868564	868550	868576	868560	Šif. / Dostupnost
	AG	43,19	47,29	50,41	54,73	55,60	71,44	67,66	92,20	MPC (€/m ²)
		325,39	356,31	379,85	412,36	418,95	538,25	509,53	694,66	MPC (Kn/m ²)
		868589	868569	868578	868553	868562	868548	868574	868558	Šif. / Dostupnost
	DG	43,19	47,29	50,41	54,73	55,60	71,44			MPC (€/m ²)
		325,39	356,31	379,85	412,36	418,95	538,25			MPC (Kn/m ²)
		868592	868572	866930	868556	868565	868551			Šif. / Dostupnost

LEONARDO **WATERFRONT**



LEONARDO Waterfront | G | 90x90 | Naturale



W



B



CP



G

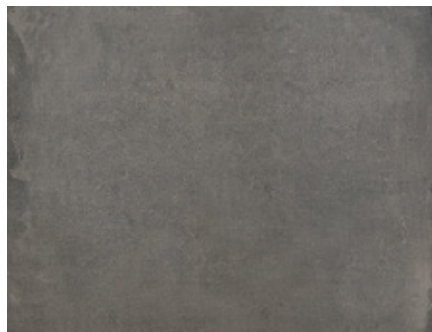







N



Dva su stila u jednoj pločici: tradicionalno i moderno. Zanosna kolekcija Waterfront prostorima daje klasičan stil s dodirrom suvremenog prostora te u potpunosti odgovara ukusu onih koji traže minimalizam.

LEONARDO WATERFRONT

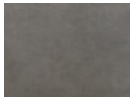
				
		60x60	90x90	Format (cm)
		10	10	Debljina (mm)
		Naturale	Naturale	Završna obrada
		R10 A	R10 A	Protukliznost
	W	47,29	51,87	MPC (€/m ²)
		356,30	390,81	MPC (Kn/m ²)
		440595	440590	Šif. / Dostupnost
	B	47,29	51,87	MPC (€/m ²)
		356,30	390,81	MPC (Kn/m ²)
		440591	440586	Šif. / Dostupnost
	CP	47,29	51,87	MPC (€/m ²)
		356,30	390,81	MPC (Kn/m ²)
		440592	440587	Šif. / Dostupnost
	G	47,29	51,87	MPC (€/m ²)
		356,30	390,81	MPC (Kn/m ²)
		440593	440588	Šif. / Dostupnost
	N	47,29	51,87	MPC (€/m ²)
		356,30	390,81	MPC (Kn/m ²)
		440594	440589	Šif. / Dostupnost

LEA CONCRETO

Concreto je kolekcija koju je dizajnirao talijanski arhitekt i dizajner Fabio Novembre, a inspiraciju je pronašao u kapljici vode i njezinom ponašanju na površinama.

Ova kolekcija će svaki prostor učiniti impresivnim. Nadahnuće je u cementu iz kojega proizlaze nijanse boja; od svijetlo sive do tamno sive čime se na kraju postiže glamurozan izgled prostora.



LEA Concreto | Light | 120x120 | Naturale

Prilikom narudžbe ploča velikih formata (120x260), naplaćuje se paleta. Po povratu palete, vrši se povrat novca.

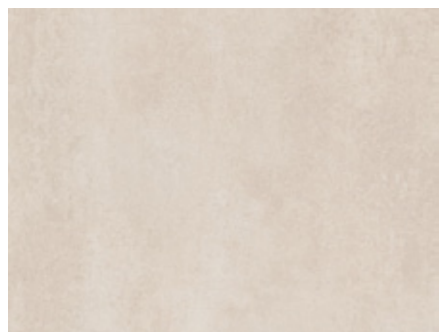

Extra Light

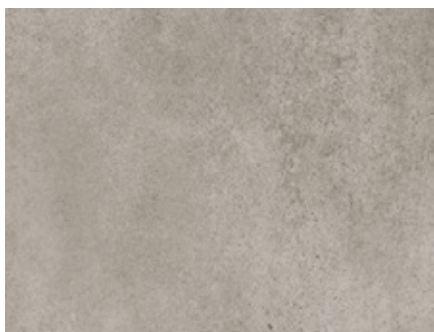

Light

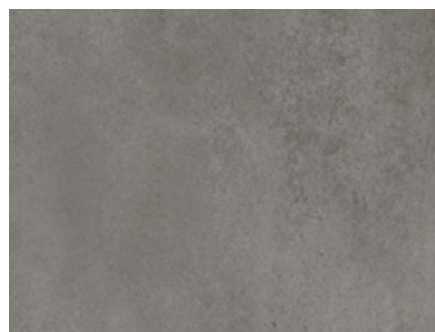

Medium

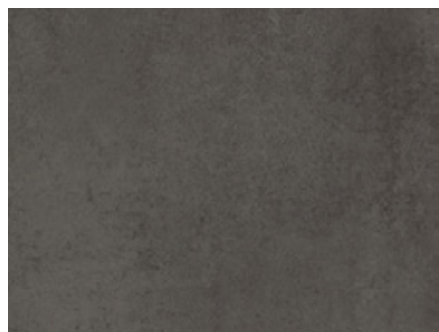

Dark

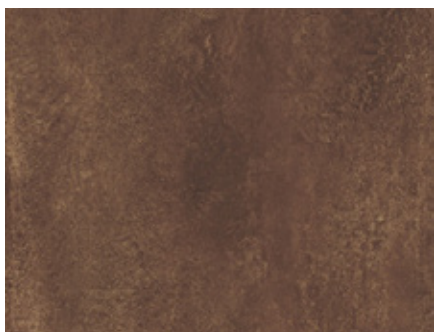

Rust

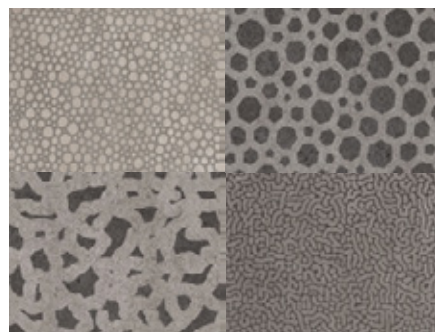







Zoom Mix





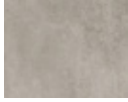
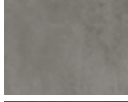
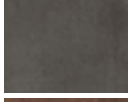







LEA Concreto | Light | 90x90 | Naturale

LEA CONCRETO

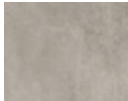
									
		20x20	30x60	60x60	45x90	Format (cm)			
		9,5	9,5	9,5	9,5	Debljina (mm)			
		Naturale	Naturale	Naturale	Naturale	Naturale	Naturale	Završna obrada	
		R10 B	R10 B	R10 B	R10 B	R10 B	R10 B	Protukliznost	
	Extra Light		46,54	50,21	46,54	50,21	53,88	56,33	MPC (€/m ²)
			350,63	378,30	350,63	378,30	405,99	424,44	MPC (Kn/m ²)
			823707	823703	823727	823723	823715	823711	Šif. / Dostupnost
	Light		46,54	50,21	46,54	50,21	53,88	56,33	MPC (€/m ²)
			350,63	378,30	350,63	378,30	405,99	424,44	MPC (Kn/m ²)
			823709	823705	823729	823725	823717	823713	Šif. / Dostupnost
	Medium		46,54	50,21	46,54	50,21	53,88	56,33	MPC (€/m ²)
			350,63	378,30	350,63	378,30	405,99	424,44	MPC (Kn/m ²)
			823708	823704	823728	823724	823716	823712	Šif. / Dostupnost
	Dark		46,54	50,21	46,54	50,21	53,88	56,33	MPC (€/m ²)
			350,63	378,30	350,63	378,30	405,99	424,44	MPC (Kn/m ²)
			823710	823706	823730	823726	823718	823714	Šif. / Dostupnost
	Rust								MPC (€/m ²)
									MPC (Kn/m ²)
									Šif. / Dostupnost
	Zoom Mix		82,43		46,31				MPC (€/m ²)
			621,04		348,93				MPC (Kn/m ²)
			823702		823697				Šif. / Dostupnost

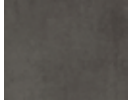

						Format (cm)	
	90x90	60x120	120x120	120x260	90x90	Format (cm)	
	9,5	6	6	6	20	Debljina (mm)	
	Naturale	Lappato	Naturale	Naturale	Naturale	Završna obrada	
	R10 B		R10	R10	R11 C	Protukliznost	
	53,88	56,33	74,70	74,70	85,72	86,95	MPC (€/m ²)
	405,99	424,44	562,84	562,84	645,89	655,11	MPC (Kn/m ²)
	823735	823731	603542	603540	603541	823751	Šif. / Dostupnost
	53,88	56,33	74,70	74,70	85,72	86,95	MPC (€/m ²)
	405,99	424,44	562,84	562,84	645,89	655,11	MPC (Kn/m ²)
	823737	823733	603551	603552	603550	823754	Šif. / Dostupnost
	53,88	56,33	74,70	74,70	85,72	86,95	MPC (€/m ²)
	405,99	424,44	562,84	562,84	645,89	655,11	MPC (Kn/m ²)
	823736	823732	603556	603557	603555	823752	Šif. / Dostupnost
	53,88	56,33	74,70	74,70	85,72	86,95	MPC (€/m ²)
	405,99	424,44	562,84	562,84	645,89	655,11	MPC (Kn/m ²)
	823738	823734	603546	603547	603545	823753	Šif. / Dostupnost
			74,70	74,70	85,72		MPC (€/m ²)
			562,84	562,84	645,89		MPC (Kn/m ²)
			603561	603562	603560		Šif. / Dostupnost
							MPC (€/m ²)
							MPC (Kn/m ²)
							Šif. / Dostupnost



LEA Concreto Zoom Mix | 20x20 | Naturale

PRISSMACER **NUNKY**





Blanco



Arena



Gris



Dekor Mix

Prissmacer Nunky je još jedna kolekcija koja imitira beton, no ono što je čini drugačijom i posebnom su dekori.

Čak četiri različita dekora poslužit će kao savršeni parovi baznim bojama što ovu kolekciju čini izuzetno zanimljivom i laganom za kombiniranje.



PRISSMACER NUNKY

		30x90	Format (cm)
		10,5	Debljina (mm)
		Satinato	Završna obrada
			Protukliznost
	Blanco	23,60	MPC (€/m ²)
		177,84	MPC (Kn/m ²)
		583170/L	Šif. / Dostupnost
	Arena	23,60	MPC (€/m ²)
		177,84	MPC (Kn/m ²)
		583167/L	Šif. / Dostupnost
	Gris	23,60	MPC (€/m ²)
		177,84	MPC (Kn/m ²)
		583171/L	Šif. / Dostupnost
	Dekor Mix	24,21	MPC (€/m ²)
		182,40	MPC (Kn/m ²)
		583216/L	Šif. / Dostupnost

PRISSMACER **START**



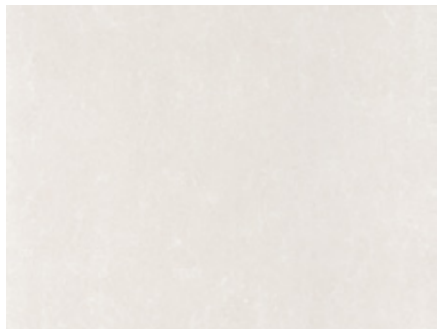

Light



Mud

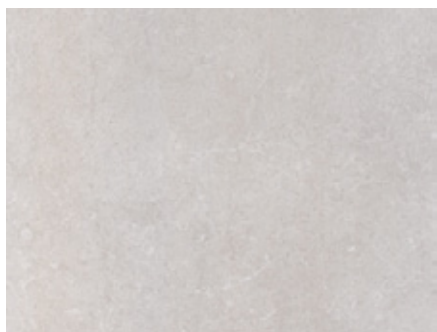

Silver



Topo

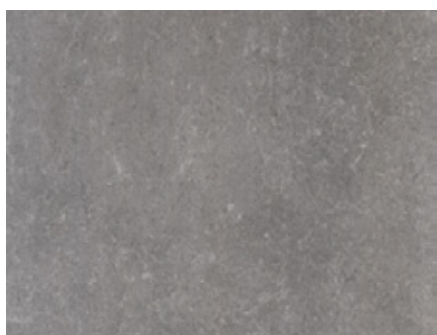

Argent

Kolekcija Start nudi beskrajno mnogo kombinacija boja, tekstura i mjera te se unutar kolekcije mogu pronaći boje koje su prikladne za unutarnje i vanjske prostore.

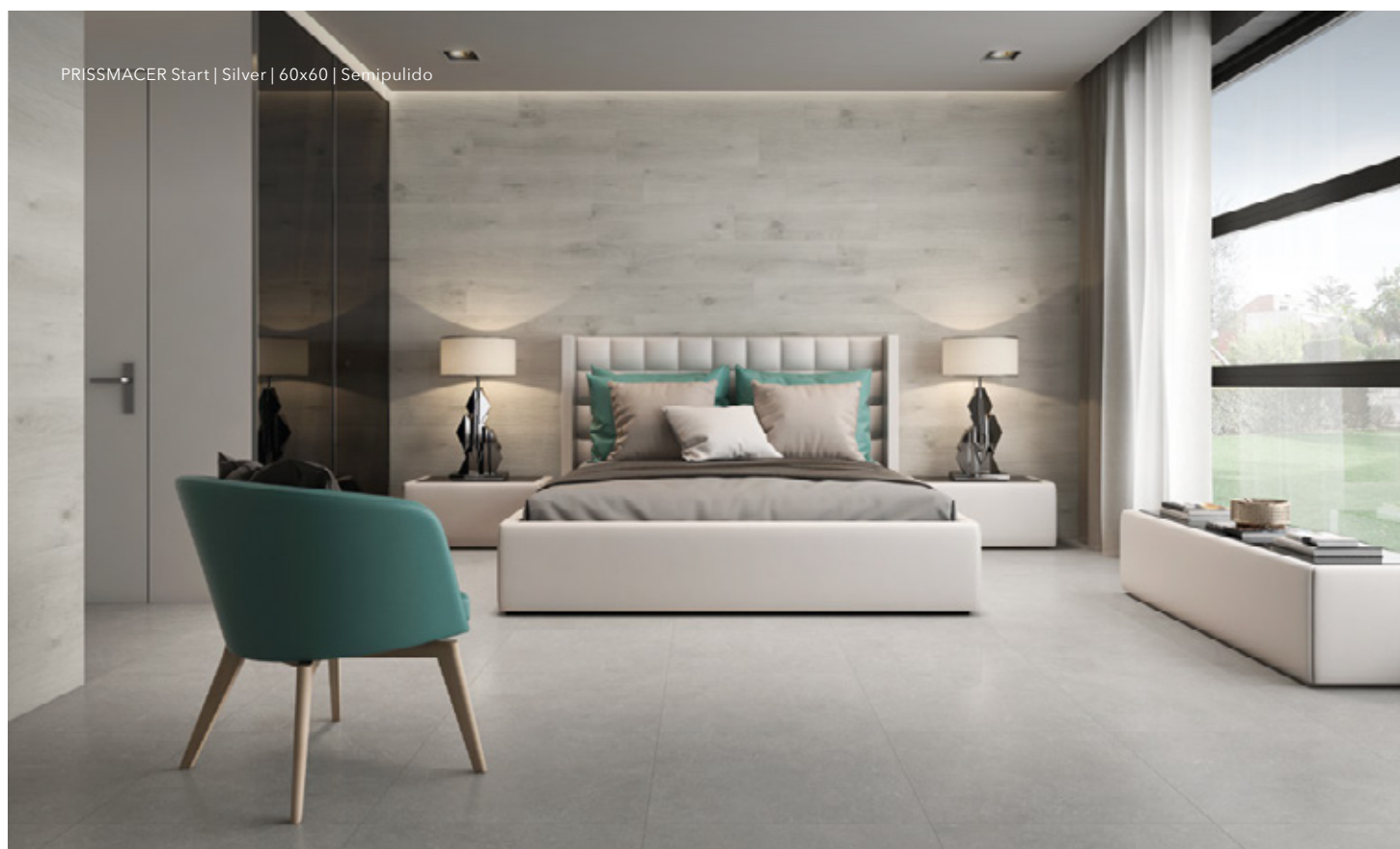

Urbanost betona i pomalo industrijski stil i ovdje su poslužili kao glavna nit vodilja.





Pod PRISMACER Start | Mud | 60x60 | Naturale
Zid PRISMACER Start | Mud | 45x90 | Naturale

PRISMACER START

		 30x60			 60x60			 60x120		Format (cm)
		10			10			11		Debljina (mm)
		Naturale	Semipul.	Grip	Naturale	Semipul.	Grip	Naturale	Semipul.	Završna obrada
		R9		R11	R9		R11	R9		Protukliznost
Light		23,00	28,45	24,21	34,80	28,45	36,31	42,36	46,90	MPC (€/m ²)
		173,28	214,32	182,40	262,19	214,32	273,59	319,19	353,39	MPC (Kn/m ²)
		553132/Ⓛ	553763/Ⓛ	553766/Ⓛ	584625	553769/Ⓛ	583914	889315	604644	Šif. / Dostupnost
Mud		23,00	28,45	24,21	34,80	28,45	36,31	42,36	46,90	MPC (€/m ²)
		173,28	214,32	182,40	262,19	214,32	273,59	319,19	353,39	MPC (Kn/m ²)
		553762/Ⓛ	553765/Ⓛ	553768/Ⓛ	584628	553771/Ⓛ	824795	889316	866907	Šif. / Dostupnost
Silver		23,00	28,45	24,21	34,80	28,45	36,31	42,36	46,90	MPC (€/m ²)
		173,28	214,32	182,40	262,19	214,32	273,59	319,19	353,39	MPC (Kn/m ²)
		553061/Ⓛ	553764/Ⓛ	553767/Ⓛ	553059	553770/Ⓛ	553060	604645	867715	Šif. / Dostupnost
Topo		34,80	41,61	36,31	34,80	41,61	36,31	42,36	46,90	MPC (€/m ²)
		262,21	313,50	273,59	262,19	313,50	273,59	319,19	353,39	MPC (Kn/m ²)
		603763	603762	584760	584678	583912	889313	889318	889320	Šif. / Dostupnost
Argent		34,80	41,61	36,31	34,80	41,61	36,31	42,36	46,90	MPC (€/m ²)
		262,21	313,50	273,59	262,19	313,50	273,59	319,19	353,39	MPC (Kn/m ²)
		584682	584679	573714	584680	583913	889314	889319	889321	Šif. / Dostupnost



45x90			75x75			120x120		75x150		Format (cm)
11			11			11		11		Debljina (mm)
Naturale	Semipul.	Grip	Naturale	Semipul.	Grip	Naturale	Semipul.	Naturale	Semipul.	Završna obrada
R9		R11	R9		R11	R9		R9		Protukliznost
36,31	42,36	37,82	40,85	45,39	42,36	59,01	65,06	49,17	55,98	MPC (€/m ²)
273,60	319,19	284,99	307,79	342,00	319,19	444,59	490,20	370,50	421,80	MPC (Kn/m ²)
889322	889325	889329	889332	889337	578471	889346	889351	889354	889363	Šif. / Dostupnost
36,31	42,36	37,82	40,85	45,39	42,36	59,01	65,06	49,17	55,98	MPC (€/m ²)
273,60	319,19	284,99	307,79	342,00	319,19	444,59	490,20	370,50	421,80	MPC (Kn/m ²)
824843	824845	824846	889333	889338	889342	824793	889364	889355	889362	Šif. / Dostupnost
36,31	42,36	37,82	40,85	45,39	42,36	59,01	65,06	49,17	55,98	MPC (€/m ²)
273,60	319,19	284,99	307,79	342,00	319,19	444,59	490,20	370,50	421,80	MPC (Kn/m ²)
824100	889326	889330	889334	889339	889343	889347	889352	889356	889361	Šif. / Dostupnost
36,31	42,36	37,82	40,85	45,39	42,36	59,01	65,06	49,17	55,98	MPC (€/m ²)
273,60	319,19	284,99	307,79	342,00	319,19	444,59	490,20	370,50	421,80	MPC (Kn/m ²)
889323	889327	889331	889335	889340	889344	889348	889353	889357	889360	Šif. / Dostupnost
36,31	42,36	37,82	40,85	45,39	42,36	59,01	65,06	49,17	55,98	MPC (€/m ²)
273,60	319,19	284,99	307,79	342,00	319,19	444,59	490,20	370,50	421,80	MPC (Kn/m ²)
889324	889328	586761	889336	889341	889345	889349	889350	889358	889359	Šif. / Dostupnost



CAESAR ANIMA



CAESAR Anima | Calacatta Oro | 160x320 | Lucidato

Prilikom narudžbe ploča velikih formata (120x278, 160x320), naplaćuje se paleta. Po povratu palete, vrši se povrat novca.



Statuario Venato

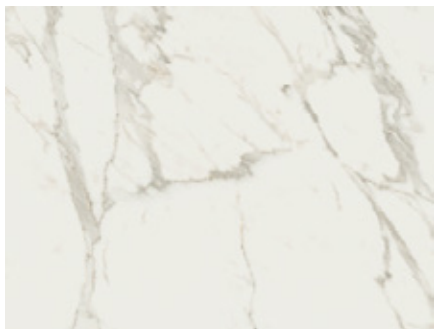

Calacatta Oro

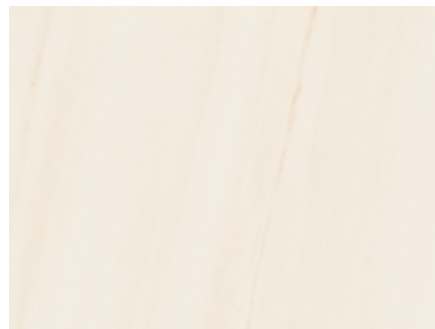

Bianco Alpino

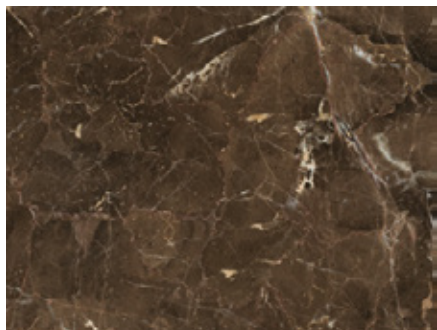

Dark Emperador

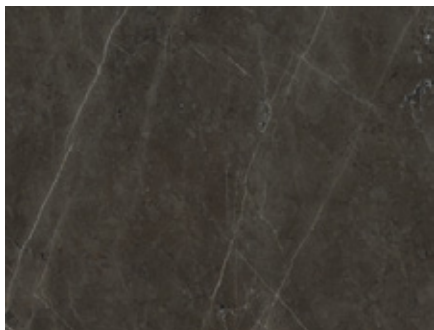

Graphite



Nero Atlante

Pločice koje imitiraju najcjenjeniji mramor i transformiraju vaš ambijent. Stvaraju plemenit ugođaj radi svojih nježnih linija i lijepih, ugodnih boja.







Ako volite izgled mramora koji nije pretjerano upadljiv, Anima kolekcija nepogrešiv je izbor. Tu su i ploče velikog formata kojima se postiže prostranost i kontinuitet.



Pod CAESAR Anima | Graphite | 120x120 | Naturale
Zid CAESAR Anima | Calacatta Oro | 60x120 | Lucidato
Dekor Composizione F | Calacatta Oro | 30x30

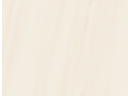

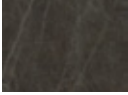





CAESAR ANIMA

		30x60		60x60		60x120		Format (cm)
		9		9		9		Debljina (mm)
		Naturale	Lucidato	Naturale	Lucidato	Naturale	Lucidato	Završna obrada
		R9		R9		R9		Protukliznost
	Statuario Venato	47,40	69,90		76,79	41,80	57,27	MPC (€/m ²)
		357,10	526,68		578,55	314,92	431,52	MPC (Kn/m ²)
		554029	597943		401440	401654/☼	443416/☼	Šif. / Dostupnost
	Calacatta Oro	47,40	69,90	50,84	76,79	41,80	57,27	MPC (€/m ²)
		357,10	526,68	383,04	578,55	314,92	431,52	MPC (Kn/m ²)
		554028	597942	597931	401671	401655/☼	443415/☼	Šif. / Dostupnost
	Bianco Alpino		69,90		76,79		57,27	MPC (€/m ²)
			526,68		578,55		431,52	MPC (Kn/m ²)
			597968		554047		554051/☼	Šif. / Dostupnost
	Dark Emperador				76,79			MPC (€/m ²)
					578,55			MPC (Kn/m ²)
					401669			Šif. / Dostupnost
	Graphite	47,40	69,90	50,84	76,79	41,80	57,27	MPC (€/m ²)
		357,10	526,68	383,04	578,55	314,92	431,52	MPC (Kn/m ²)
		554026	597941	597926	401668	401652/☼	457859/☼	Šif. / Dostupnost
	Nero Atlante	47,40	69,90	50,84	76,79	41,80	57,27	MPC (€/m ²)
		357,10	526,68	383,04	578,55	314,92	431,52	MPC (Kn/m ²)
		597955	597966	597950	554049	554041/☼	554053/☼	Šif. / Dostupnost



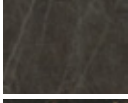

CAESAR Anima | Statuario Venato | 60x120 | Lucidato

	120x120		120x278		160x320		Format (cm)
	9		6		6		Debljina (mm)
	Naturale	Lucidato	Lucidato	Silk	Lucidato	Silk	Završna obrada
	R9						Protukliznost
	74,40	98,76		95,45	142,98		MPC (€/m ²)
			897,75	719,20	1.077,30	897,75	MPC (Kn/m ²)
	597939	457864	597948	828370	554031	597933	Šif. / Dostupnost
	74,40	98,76	119,15	95,45	142,98	119,15	MPC (€/m ²)
			897,75	719,20	1.077,30	897,75	MPC (Kn/m ²)
	597938	457863	597947	828371	554030	597934	Šif. / Dostupnost
		98,76					MPC (€/m ²)
		744,14					MPC (Kn/m ²)
		554062					Šif. / Dostupnost
							MPC (€/m ²)
							MPC (Kn/m ²)
							Šif. / Dostupnost
	74,40			95,45			MPC (€/m ²)
	560,60			719,20			MPC (Kn/m ²)
	887786			887785			Šif. / Dostupnost
			119,15		142,98	119,15	MPC (€/m ²)
			897,75		1.077,30	897,75	MPC (Kn/m ²)
			597977		597971	597959	Šif. / Dostupnost

CAESAR

ANIMA EVER

Za one koji vole izražajne linije, kolekcija Anima Ever ispunit će sva očekivanja. Guste vene sa snažnim karakterom ovu kolekciju pločica stavljaju u prvi plan svake prostorije.

Osim vizualnog dojma, Anima Ever kolekcija svaku prostoriju čini glamuroznom i nezaboravnom. Izbor olakšava i široka ponuda dimenzija, a tu su i ploče velikog formata.



Pod CAESAR Anima Ever | Apuan Gold | 80x80 | Naturale
Zid CAESAR Anima Ever | Sage Green | 60x120, 120x278 | Lucidato

Prilikom narudžbe ploča velikih formata (120x278, 160x320), naplaćuje se paleta. Po povratu palete, vrši se povrat novca.



Magnificent White

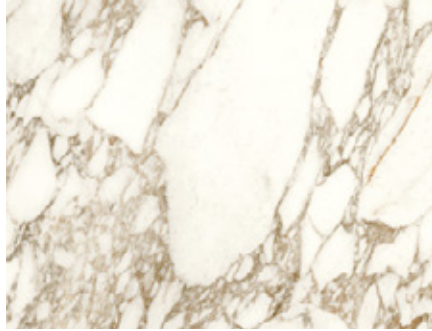

Luxury Arabesque



Apuan Gold



Sage Green



Royal Onyx

CAESAR
ANIMA EVER



		80x80	60x120		120x120	120x278	160x320	Format (cm)
		9	9		9	6	6	Debljina (mm)
		Lucidato	Naturale	Lucidato	Lucidato	Lucidato	Silk	Završna obrada
			R9					Protukliznost
	Magnificent White					119,15		MPC (€/m ²)
						897,75		MPC (Kn/m ²)
						828391		Šif. / Dostupnost
	Luxury Arabesque	80,63	41,80	57,27	98,76	119,15		MPC (€/m ²)
		607,48	314,91	431,52	744,14	897,75		MPC (Kn/m ²)
		828179	828344/☼	828348/☼	828398	828388		Šif. / Dostupnost
	Apuan Gold	80,63	41,80	57,27	98,76	119,15	119,15	MPC (€/m ²)
		607,48	314,91	431,52	744,14	897,75	897,75	MPC (Kn/m ²)
		828183	828343/☼	828347/☼	828397	828387	828376	Šif. / Dostupnost
	Sage Green			57,27	98,76	119,15		MPC (€/m ²)
				431,52	744,14	897,75		MPC (Kn/m ²)
				828350/☼	828400	828392		Šif. / Dostupnost
	Royal Onyx	80,63		57,27	98,76	119,15		MPC (€/m ²)
		607,48		431,52	744,14	897,75		MPC (Kn/m ²)
		828180		828349/☼	828399	828389		Šif. / Dostupnost

CERIM TIMELESS



Pod CERIM Timeless | Amani Grey | 80x80 | Naturale
Zid CERIM Timeless | Amani Grey | 80x240 | Lucido

Prilikom narudžbe ploča velikih formata (80x240),
naplaćuje se paleta. Po povratu palete, vrši se povrat novca.

Bezvremenska kolekcija, kao što i sam naziv glasi, vraća stil besmrtnne ljepote koji se izražava kroz šest boja i širok izbor formata.

Mramor nikada ne izlazi iz mode jer njegova ljepota proizlazi iz prirode. Upravo vječnost i bezvremenski stil prezentiraju nam pločice iz Timelessa.



CERIM Timeless | Black Deep | 60x60, 30x60 | Lucido



Pod CERIM Timeless | Calacatta | 60x120 | Naturale
Zid CERIM Timeless | Calacatta | Naturale
Mozaik CERIM Timeless | Calacatta | 30x30 | Naturale

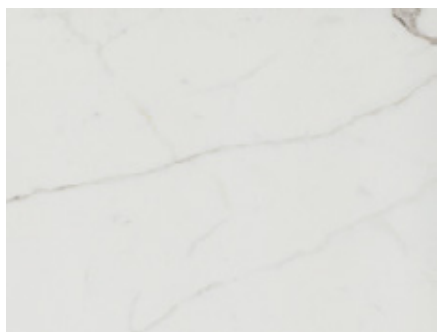

Calacatta

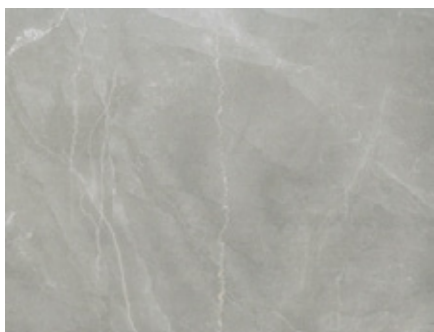

Amani Grey



Cappel di Gre



Black Deep











Travertino



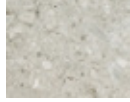



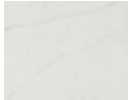

Marfil

CERIM TIMELESS

		 30x60			 60x60		 60x120		Format (cm)
		9			9		9		Debljina (mm)
		Naturale	Lucido	Grip	Naturale	Lucido	Naturale	Lucido	Završna obrada
		R9		R11 B	R9		R9		Protukliznost
	Calacatta	42,89	23,76	42,89	46,44	60,61	60,64	75,13	MPC (€/m ²)
		323,13	179,00	323,13	349,92	456,70	456,87	566,09	MPC (Kn/m ²)
		437807	437797/Ⓛ	437789	437783	□□□□□	437750	437737	Šif. / Dostupnost
	Amani Grey	42,89	57,08	42,89	46,44	60,64	60,64	75,13	MPC (€/m ²)
		323,13	430,08	323,13	349,92	456,87	456,87	566,09	MPC (Kn/m ²)
		437798	437790	437799	437776	437768	437744	437742	Šif. / Dostupnost
	Cappel di Gre	42,89	57,08	42,89	46,44	60,64	60,64	75,13	MPC (€/m ²)
		323,13	430,08	323,13	349,92	456,87	456,87	566,09	MPC (Kn/m ²)
		437803	437793	437785	437779	437771	437746	437739	Šif. / Dostupnost
	Black Deep	42,89	57,08	42,89	46,44	60,64	60,64	75,13	MPC (€/m ²)
		323,13	430,08	323,13	349,92	456,87	456,87	566,09	MPC (Kn/m ²)
		437802	437792	437784	437778	437770	437748	437741	Šif. / Dostupnost
	Travertino	42,89	57,08	42,89	46,44	60,64	60,64	75,13	MPC (€/m ²)
		323,13	430,08	323,13	349,92	456,87	456,87	566,09	MPC (Kn/m ²)
		437805	437795	437787	437781	437773	437747	437738	Šif. / Dostupnost
	Marfil	42,89	57,08	42,89	46,44	60,64	60,64	75,13	MPC (€/m ²)
		323,13	430,08	323,13	349,92	456,87	456,87	566,09	MPC (Kn/m ²)
		437806	437796	437788	437782	437774	437749	437736	Šif. / Dostupnost



	80x80		80x80		80x240		Format (cm)
	9		6		6		Debljina (mm)
	Naturale	Lucido	Naturale	Lucido	Naturale	Lucido	Završna obrada
	R9		R9		R9		Protukliznost
	64,16	78,69	67,72	94,84	88,09	118,56	MPC (€/m ²)
	483,43	592,89	510,23	714,60	663,74	893,31	MPC (Kn/m ²)
	494663	494670	437903	437895	437887	437879	Šif. / Dostupnost
	64,16	78,69	67,72	94,84	88,09	118,56	MPC (€/m ²)
	483,43	592,89	510,23	714,60	663,74	893,31	MPC (Kn/m ²)
	494657	494664	437896	437888	437880	437872	Šif. / Dostupnost
	64,16	78,69	67,72	94,84	88,09	118,56	MPC (€/m ²)
	483,43	592,89	510,23	714,60	663,74	893,31	MPC (Kn/m ²)
	494659	494666	437899	437891	437883	437875	Šif. / Dostupnost
	64,16	78,69	67,72	94,84			MPC (€/m ²)
	483,43	592,89	510,23	714,60			MPC (Kn/m ²)
	494658	494665	437898	437890			Šif. / Dostupnost
	64,16	78,69	67,72	94,84	88,09	118,56	MPC (€/m ²)
	483,43	592,89	510,23	714,60	663,74	893,31	MPC (Kn/m ²)
	494661	494668	437901	437893	437885	437877	Šif. / Dostupnost
	64,16	78,69	67,72	94,84			MPC (€/m ²)
	483,43	592,89	510,23	714,60			MPC (Kn/m ²)
	494662	494669	437902	437894			Šif. / Dostupnost



COTTO D'ESTE

ALLURE

Allure kolekcija inspirirana je plemenitim i lijepim mramorom. Kolekcija objedinjuje dizajn mramora koji je pročišćen, nježan i savršen u svojoj ljepoti klasične estetike te moderan, veličanstven stil koji se pronalazi u zadivljujućim bojama te upečatljivim uzorcima.

Iz kolekcije Allure zadovoljit će se različiti stilski zahtjevi, od uređenja doma, do uređenja objekata.



COTTO D'ESTE Allure | Orobitco | 120x120 | Glossy

Prilikom narudžbe ploča velikih formata (120x278), naplaćuje se paleta. Po povratu palete, vrši se povrat novca.

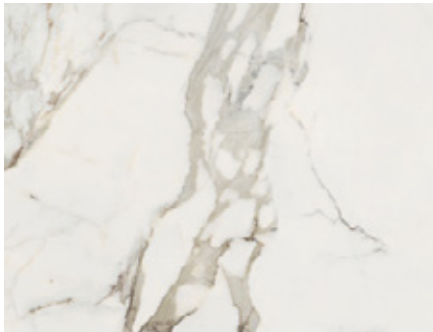

Calacatta

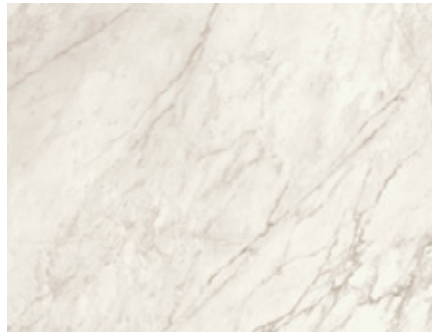

Paonazetto



Tundra J.

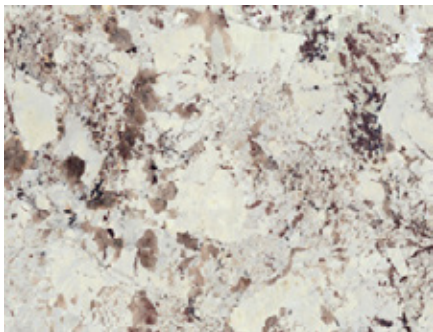

Alaska



Riviera

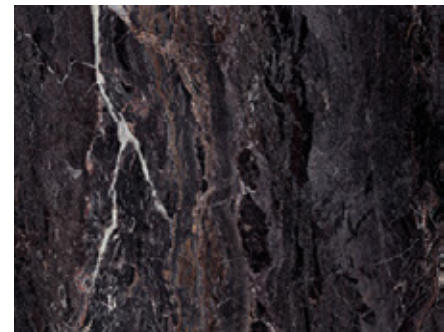

Orbico

**COTTO D'ESTE
ALLURE**

		60x120			120x120			120x278			Format (cm)
		6,5			6,5			6,5			Debljina (mm)
		Smooth	Glossy	Touch	Smooth	Glossy	Touch	Smooth	Glossy	Touch	Završna obrada
											Protukliznost
	Calacatta	86,95	115,11		86,95	115,11		91,85	120,01		MPC (€/m ²)
		655,11	867,33		655,11	867,33		692,01	904,24		MPC (Kn/m ²)
		985942	985947		985954	985959		985966	985971		Šif. / Dostupnost
	Paonazetto	86,95	115,11		86,95	115,11		91,85	120,01		MPC (€/m ²)
		655,11	867,33		655,11	867,33		692,01	904,24		MPC (Kn/m ²)
		985943	985950		985955	985962		985967	985974		Šif. / Dostupnost
	Tundra J.	86,95	115,11		86,95	115,11		91,85	120,01		MPC (€/m ²)
		655,11	867,33		655,11	867,33		692,01	904,24		MPC (Kn/m ²)
		985944	985953		985956	985965		985968	985977		Šif. / Dostupnost
	Alaska		121,24	121,24		121,24	121,24		127,36	127,36	MPC (€/m ²)
			913,46	913,46		913,46	913,46		959,60	959,60	MPC (Kn/m ²)
			985945	985946		985957	985958		985969	985970	Šif. / Dostupnost
	Riviera		121,24	121,24		121,24	121,24		127,36	127,36	MPC (€/m ²)
			913,46	913,46		913,46	913,46		959,60	959,60	MPC (Kn/m ²)
			985951	985952		985963	985964		985975	985976	Šif. / Dostupnost
	Orbico		124,91	124,91		124,91	124,91		129,81	129,81	MPC (€/m ²)
			941,14	941,14		941,14	941,14		978,05	978,05	MPC (Kn/m ²)
			985948	985949		985960	985961		985972	985973	Šif. / Dostupnost



COTTO D'ESTE

VANITY

Suptilni uzorci i lagane vene koje su nježno zasjenjene, čine dizajn ove kolekcije posebnim.

Vanity pronalazi inspiraciju u kamenu koji se koristio za skulpture u renesansi, stoga stvara pločicu koja djeluje poput umjetničkog djela.



COTTO D'ESTE Vanity | Macchia Vecchia Bookmatch A+B | 120x260 | Glossy

Prilikom narudžbe ploča velikih formata (120x260), naplaćuje se paleta. Po povratu palete, vrši se povrat novca.

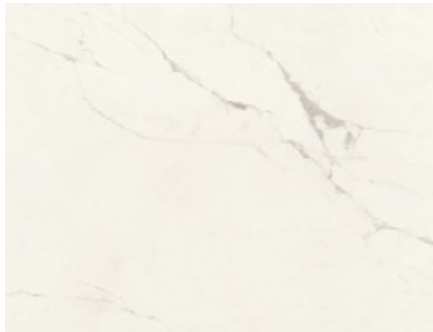

Bianco Luce

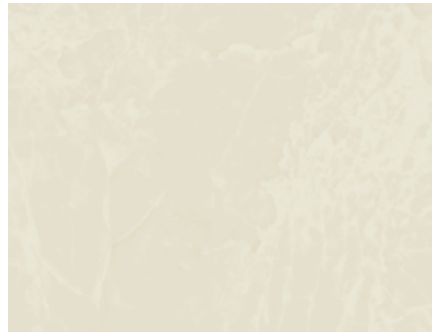

Onice Royal



Bianco Statuario



Macchia Vecchia

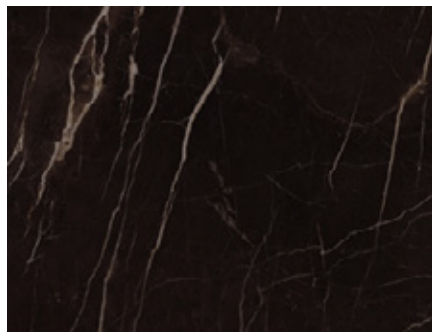

Dark Brown

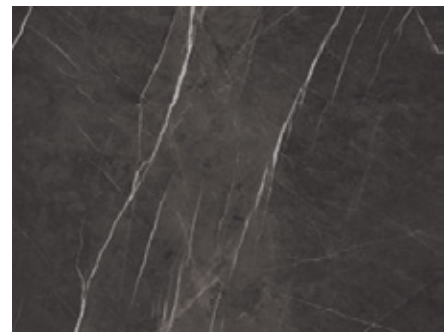

Pietra Grey

**COTTO D'ESTE
VANITY**



60x120







120x120

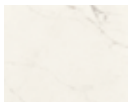

120x260



	60x120		120x120		120x260		Format (cm)	
	6,5		6,5		6,5		Debljina (mm)	
	Glossy	Touch	Glossy	Touch	Glossy	Touch	Završna obrada	
							Protukliznost	
	Bianco Luce	104,09	104,09	104,09	104,09	117,56	117,56	MPC (€/m ²)
		784,29	784,29	784,29	784,29	885,78	885,78	MPC (Kn/m ²)
		866719	866713	604294	604291	604300	604297	Šif. / Dostupnost
	Onice Royal	104,09	104,09	104,09	104,09	117,56	117,56	MPC (€/m ²)
		784,29	784,29	784,29	784,29	885,78	885,78	MPC (Kn/m ²)
		866723	866717	866728	866726	866733	866731	Šif. / Dostupnost
	Bianco Statuario	104,09	104,09	104,09	104,09	117,56	117,56	MPC (€/m ²)
		784,29	784,29	784,29	784,29	885,78	885,78	MPC (Kn/m ²)
		866720	866714	604293	604290	604299	604296	Šif. / Dostupnost
	Macchia Vecchia	104,09	104,09	104,09	104,09	117,56	117,56	MPC (€/m ²)
		784,29	784,29	784,29	784,29	885,78	885,78	MPC (Kn/m ²)
		866722	866716	858597	866725	859325	866730	Šif. / Dostupnost
	Dark Brown	104,09	104,09	104,09	104,09	117,56	117,56	MPC (€/m ²)
		784,29	784,29	784,29	784,29	885,78	885,78	MPC (Kn/m ²)
		866721	866715	604295	604292	604301	604298	Šif. / Dostupnost
	Pietra Grey	104,09	104,09	104,09	104,09	117,56	117,56	MPC (€/m ²)
		784,29	784,29	784,29	784,29	885,78	885,78	MPC (Kn/m ²)
		866724	866718	866729	866727	866734	866732	Šif. / Dostupnost

IMOLA THE ROOM

Imola the Room savršeno prikazuje kvalitetan mramor i njegovu prirodnu kreativnost. Ova kolekcija nudi četiri prijedloga dimenzija, ovisno o vašim preferencijama.

Radi se o osam različitih "mramora", kako izgledom tako i podrijetlom. Jedinstvena kolekcija sposobna je udovoljiti najsofisticiranijim ukusima, za vrhunsko moderno i originalno okruženje.



IMOLA The Room | INV WH | 120x120 | Glossy

Prilikom narudžbe ploča velikih formata (120x260), naplaćuje se paleta za koju se ne vrši povrat novca.



ABS WH

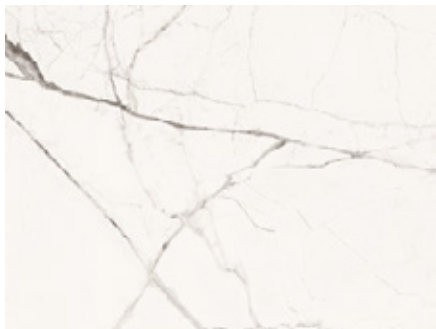

STA VP



INV WH



PAN WH



PAT WH

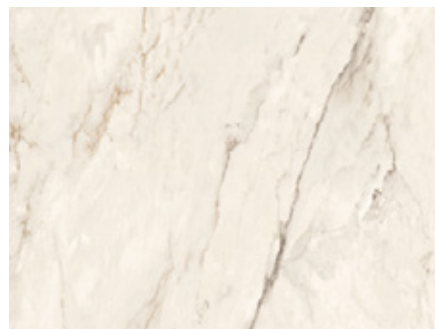

CRE DL



SAN PE



BLA DA

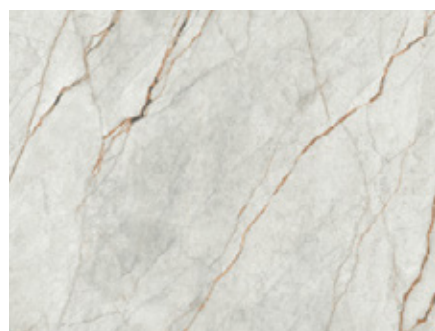

GRE RO

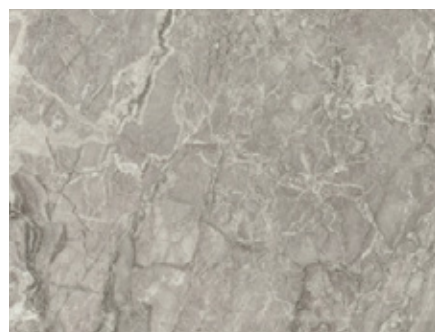

BRE DU

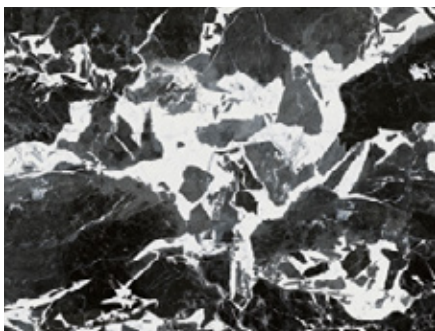

GRA AN



INF BR



BLU AQ

IMOLA THE ROOM



60x60



60x120



120x120

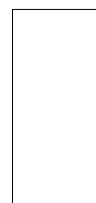

120x260



		60x60		60x120		120x120		120x260		Format (cm)
		6,5		6,5		6,5		6,5		Debljina (mm)
		Naturale	Glossy	Naturale	Glossy	Naturale	Glossy	Naturale	Glossy	Završna obrada
		R9 A		R9 A		R9 A		R9 A		Protukliznost
	ABS WH			68,82	90,50	83,94	105,62		144,28	MPC (€/m ²)
				518,50	681,89	632,41	795,80		1.087,08	MPC (Kn/m ²)
				992029	992033	992022	992025		992019	Šif. / Dostupnost
	STA VP	55,60	77,32	68,82	90,50	83,94	105,62	114,07	144,28	MPC (€/m ²)
		418,95	582,54	518,50	681,89	632,41	795,80	859,45	1.087,08	MPC (Kn/m ²)
		597326	597330	596788	596789	597314	597317	597308	597312	Šif. / Dostupnost
	INV WH			68,82	90,50	83,94	105,62		144,28	MPC (€/m ²)
				518,50	681,89	632,41	795,80		1.087,08	MPC (Kn/m ²)
				847387	847391	847379	847383		847375	Šif. / Dostupnost
	PAN WH			68,82	90,50	83,94	105,62		144,28	MPC (€/m ²)
				518,50	681,89	632,41	795,80		1.087,08	MPC (Kn/m ²)
				847388	847392	847380	847384		847376	Šif. / Dostupnost
	PAT WH			68,82	90,50	83,94	105,62			MPC (€/m ²)
				518,50	681,89	632,41	795,80			MPC (Kn/m ²)
				992030	992034	986158	992026			Šif. / Dostupnost
	CRE DL	55,60	77,32	68,82	90,50	83,94	105,62	114,07	144,28	MPC (€/m ²)
		418,95	582,54	518,50	681,89	632,41	795,80	859,45	1.087,08	MPC (Kn/m ²)
		597325	597329	597320	597322	597313	597316	597307	597311	Šif. / Dostupnost
	SAN PE	49,94	71,62	50,54	84,86	77,32	99,00	107,50	137,66	MPC (€/m ²)
		376,26	539,65	380,81	639,40	582,54	745,93	809,98	1.037,20	MPC (Kn/m ²)
		597328	597332	586737/Ⓛ	597324	597315	597319	597310	586736	Šif. / Dostupnost
	BLA DA			63,18	84,86	77,32	99,00		137,66	MPC (€/m ²)
				476,01	639,40	582,54	745,93		1.037,20	MPC (Kn/m ²)
				847389	847393	847381	847385		847377	Šif. / Dostupnost
	GRE RO			50,54	84,86	77,32	99,00		137,66	MPC (€/m ²)
				380,81	639,40	582,54	745,93		1.037,20	MPC (Kn/m ²)
				992032/Ⓛ	992037	991187	986330		992021	Šif. / Dostupnost
	BRE DU			63,18	84,86	77,32	99,00		137,66	MPC (€/m ²)
				476,01	639,40	582,54	745,93		1.037,20	MPC (Kn/m ²)
				992031	992036	992024	992028		992020	Šif. / Dostupnost
	GRA AN			63,18	84,86	77,32	99,00		137,66	MPC (€/m ²)
				476,01	639,40	582,54	745,93		1.037,20	MPC (Kn/m ²)
				847390	847394	847382	847386		847378	Šif. / Dostupnost
	INF BR	49,94	71,62	63,18	84,86	77,32	99,00	107,50	137,66	MPC (€/m ²)
		376,26	539,65	476,01	639,40	582,54	745,93	809,98	1.037,20	MPC (Kn/m ²)
		597327	597331	597321	597323	586735	597318	597309	586734	Šif. / Dostupnost
	BLU AQ			63,18	84,86	77,32	99,00		137,66	MPC (€/m ²)
				476,01	639,40	582,54	745,93		1.037,20	MPC (Kn/m ²)
				986081	992035	992023	992027		986325	Šif. / Dostupnost

LEA DELIGHT



Pod LEA Delight | Calacatta Oro | 120x120 | Levigato
Zid LEA Delight | Calacatta Oro | Chain 120x260 | Levigato

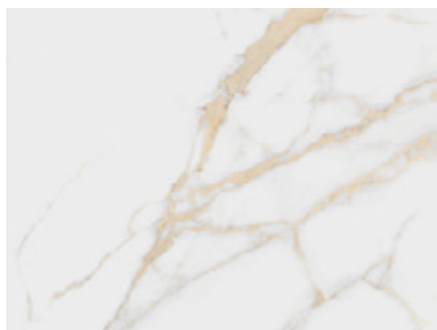

Calacatta Oro



Venato Bianco

Delight kolekcija sastoji se od četiri pomno birane boje te četiri različite završne obrade koje pružaju posebno taktilno iskustvo.

Ploče je moguće dobiti i u nekoliko različitih velikih formata, a unutar kolekcije svako pronalazi nešto za sebe: od suptilnih i nježnih vena, do onih gustih, snažnog karaktera.

Prilikom narudžbe ploča velikih formata (120x260), naplaćuje se paleta. Po povratu palete, vrši se povrat novca.



Invisible Light



Marquina Nero



**LEA
DELIGHT**

		30x60		60x60		60x120		90x90	Format (cm)
		9,5		9,5		9,5		9,5	Debljina (mm)
		Naturale	Lux	Naturale	Lux	Naturale	Lux	Naturale	Završna obrada
		R9		R9		R9		R9	Protukliznost
	Calacatta Oro	39,07	54,96	39,07	54,96	47,15	64,66	48,50	MPC (€/m ²)
		294,34	414,10	294,34	414,10	355,24	487,18	365,39	MPC (Kn/m ²)
		853529	853525	853545	853541	853537	853533	853553	Šif. / Dostupnost
	Venato Bianco		54,96		54,96		64,66		MPC (€/m ²)
			414,10		414,10		487,18		MPC (Kn/m ²)
			853528		853544		853536		Šif. / Dostupnost
	Invisible Light		54,96		54,96		64,66		MPC (€/m ²)
			414,10		414,10		487,18		MPC (Kn/m ²)
			853526		853542		853534		Šif. / Dostupnost
	Marquina Nero		54,96		54,96		64,66		MPC (€/m ²)
			414,10		414,10		487,18		MPC (Kn/m ²)
			853527		853543		853535		Šif. / Dostupnost

		60x120			120x120			120x260			Format (cm)
		6			6			6			Debljina (mm)
		Naturale	Levigato	Touch	Naturale	Levigato	Touch	Naturale	Levigato	Touch	Završna obrada
		R9			R9			R9			Protukliznost
	Calacatta Oro	79,60	101,64	101,64	79,60	101,64	101,64	93,07	117,56	117,56	MPC (€/m ²)
		599,75	765,83	765,83	599,75	765,83	765,83	701,24	885,78	885,78	MPC (Kn/m ²)
		603711	603699	603703	603707	603687	603691	603695	603679	603683	Šif. / Dostupnost
	Venato Bianco		101,64	101,64		101,64	101,64		117,56	117,56	MPC (€/m ²)
			765,83	765,83		765,83	765,83		885,78	885,78	MPC (Kn/m ²)
			603702	603706		603690	603694		603682	603686	Šif. / Dostupnost
	Invisible Light		101,64	101,64		101,64	101,64		117,56	117,56	MPC (€/m ²)
			765,83	765,83		765,83	765,83		885,78	885,78	MPC (Kn/m ²)
			603700	603704		603688	603692		603680	603684	Šif. / Dostupnost
	Marquina Nero		101,64	101,64		101,64	101,64		117,56	117,56	MPC (€/m ²)
			765,83	765,83		765,83	765,83		885,78	885,78	MPC (Kn/m ²)
			603701	603705		603689	603693		603681	603685	Šif. / Dostupnost

PRISSMACER

Unutar kategorije Prissmacer nalazi se nekoliko kolekcija koje imitiraju mramor i međusobno se savršeno slažu.

Sve pločice dolaze u dvije obrade, a ove mini kolekcije su idealan izbor za ljubitelje minimalizma. Nježne žile ne dolaze u prvi plan i lijepe su upravo radi svoje decentnosti.



Pod PRISSMACER | Calacatta | 60x120 | Glossy
Zid PRISSMACER | Venus | 30x90 | Glossy; Isis Dekor | 30x90 | Naturale



Venus



Venus Dekor

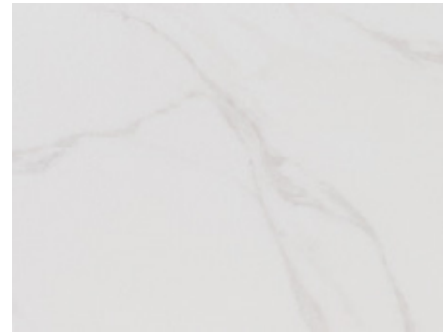

Isis



Isis Dekor

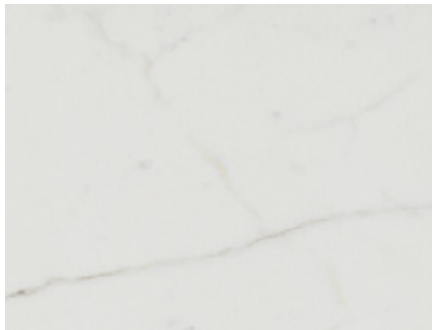









Calacatta



Statuario

PRISSMACER

		 60x60 10		 30x90 10,5		 60x120 9		Format (cm)
								Debljina (mm)
		Naturale	Glossy	Naturale	Glossy	Naturale	Glossy	Završna obrada
								Protukliznost
	Venus	19,97		23,60				MPC (€/m ²)
		150,48		177,84				MPC (Kn/m ²)
		889370/Ⓛ		889369/Ⓛ				Šif. / Dostupnost
	Venus Dekor			24,21				MPC (€/m ²)
				182,40				MPC (Kn/m ²)
				889368/Ⓛ				Šif. / Dostupnost
	Isis	19,97		23,60				MPC (€/m ²)
		150,48		177,84				MPC (Kn/m ²)
		889373/Ⓛ		889372/Ⓛ				Šif. / Dostupnost
	Isis Dekor			24,21				MPC (€/m ²)
				182,40				MPC (Kn/m ²)
				889371/Ⓛ				Šif. / Dostupnost
	Calacatta	27,84				29,05 33,29		MPC (€/m ²)
		209,76				218,88 250,80		MPC (Kn/m ²)
		887715/Ⓛ				889367/Ⓛ 606057/Ⓛ		Šif. / Dostupnost
	Statuario					24,81 25,42		MPC (€/m ²)
						186,96 191,52		MPC (Kn/m ²)
						612319/Ⓛ 612318/Ⓛ		Šif. / Dostupnost

PRISSMACER

OPERA

Kolekcija Opera nudi vam imitaciju mramora u svijetlim bojama, decentna je te se u prostoriji stapa s drugim zemljanim tonovima.

Za one koji žele nešto drugačije, Opera nudi posebne dekore.

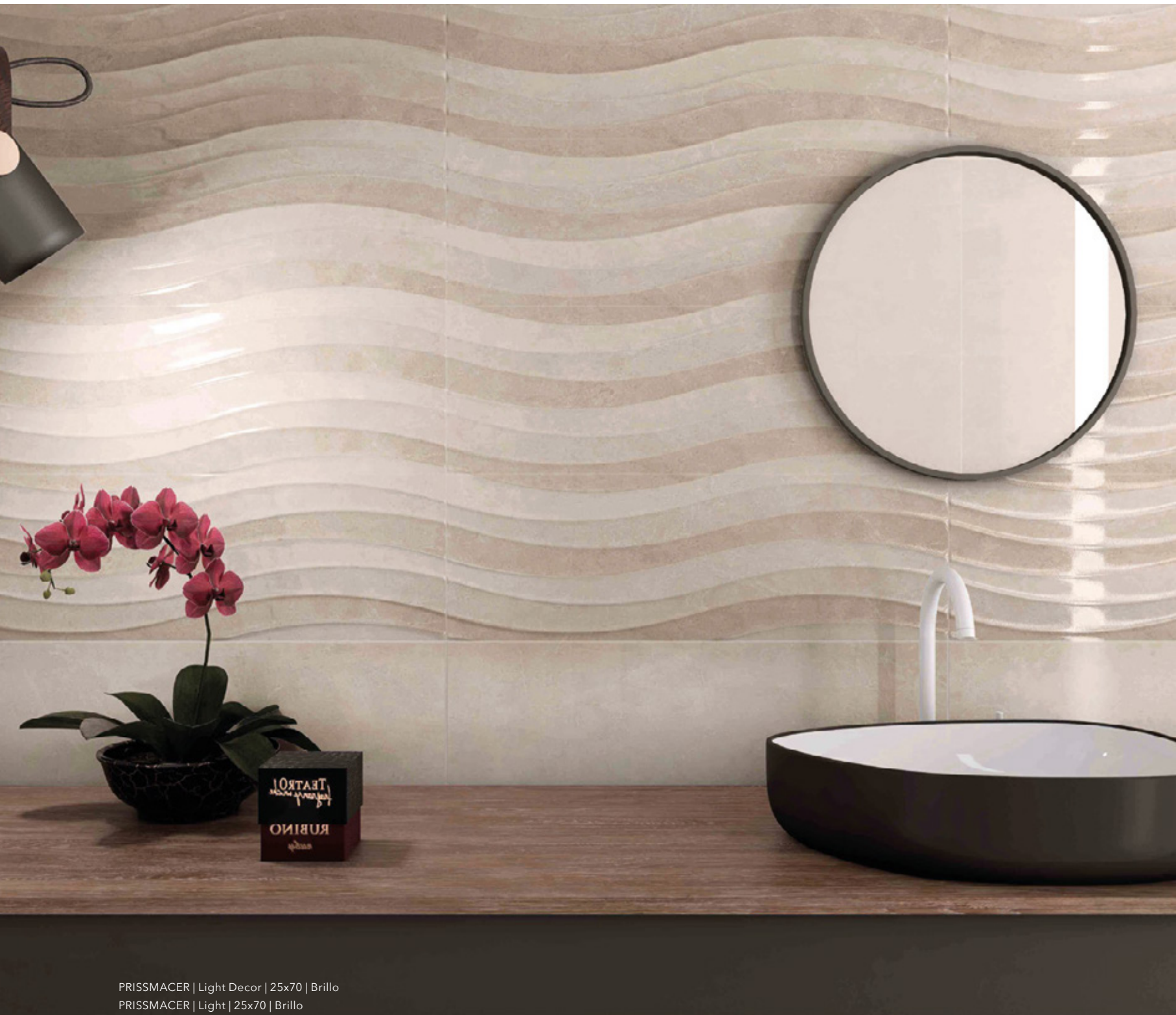



Perla



Light



Perla Dekor



Light Dekor





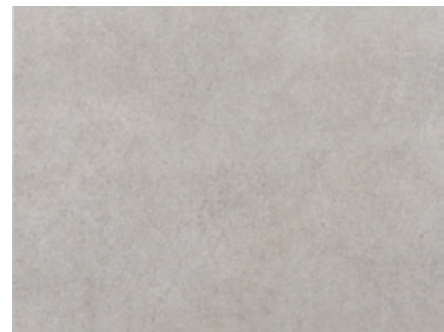

Reine Taupe

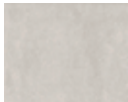
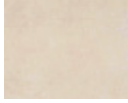

Reine Gris

**PRISSMACER
OPERA**

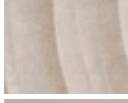
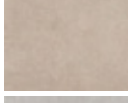
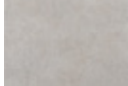
				
		25x70	45x45	Format (cm)
		8,5	8,5	Debljina (mm)
		Brillo	Satinato	Završna obrada
				Protukliznost
	Perla	16,34		MPC (€/m ²)
		123,12		MPC (Kn/m ²)
		583201/Ⓛ		Šif. / Dostupnost
	Light	16,34		MPC (€/m ²)
		123,12		MPC (Kn/m ²)
		583203/Ⓛ		Šif. / Dostupnost
	Perla Dekor	16,95		MPC (€/m ²)
		127,68		MPC (Kn/m ²)
		583205/Ⓛ		Šif. / Dostupnost
	Light Dekor	16,95		MPC (€/m ²)
		127,68		MPC (Kn/m ²)
		583206/Ⓛ		Šif. / Dostupnost
	Reine Taupe		15,13	MPC (€/m ²)
			114,00	MPC (Kn/m ²)
			597361/Ⓛ	Šif. / Dostupnost
	Reine Gris		15,13	MPC (€/m ²)
			114,00	MPC (Kn/m ²)
			597360/Ⓛ	Šif. / Dostupnost

REX

ETOILE DE REX



REX Etoile de Rex | Creme | 120x280 | Naturale

Étoile de Rex kolekcija je koja proizlazi iz nevjerojatne raznolikosti kakva se može pronaći jedino u prirodi.

Savršena elegancija mramora može sadržavati žile u raznovrsnim bojama: od bijele i sive, pa sve do zelene. Ove posebno lijepe pločice donose vam dašak otmjenosti.

Prilikom narudžbe ploča velikih formata (120x240, 160x160, 120x280, 160x320), naplaćuje se paleta. Po povratu palete, vrši se povrat novca.

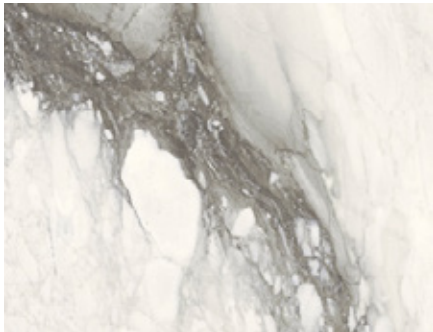

Renoir



Creme



Gris



Tropical



Symphonie



Illusion

REX
ETOILE DE REX



60x60









60x120

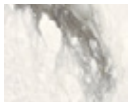

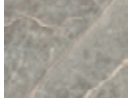





80x80

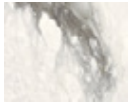

		60x60		60x120		80x80		Format (cm)
		9		9		9		Debljina (mm)
		Naturale	Glossy	Naturale	Glossy	Naturale	Glossy	Završna obrada
								Protukliznost
	Renoir	57,71	68,05	84,81	95,15	81,58	91,60	MPC (€/m ²)
		434,84	512,73	638,98	716,88	614,69	690,09	MPC (Kn/m ²)
		605371	605375	597433	605359	605363	605367	Šif. / Dostupnost
	Creme	57,71	68,05	84,81	95,15	81,58	91,60	MPC (€/m ²)
		434,84	512,73	638,98	716,88	614,69	690,09	MPC (Kn/m ²)
		605373	605377	605357	605361	605365	605369	Šif. / Dostupnost
	Gris	57,71	68,05	84,81	95,15	81,58	91,60	MPC (€/m ²)
		434,84	512,73	638,98	716,88	614,69	690,09	MPC (Kn/m ²)
		605372	605376	605356	605360	605364	605368	Šif. / Dostupnost
	Tropical	57,71	68,05	84,81	95,15	81,58	91,60	MPC (€/m ²)
		434,84	512,73	638,98	716,88	614,69	690,09	MPC (Kn/m ²)
		605374	605378	605358	605362	605366	605370	Šif. / Dostupnost
	Symphonie							MPC (€/m ²)
								MPC (Kn/m ²)
								Šif. / Dostupnost
	Illusion							MPC (€/m ²)
								MPC (Kn/m ²)
								Šif. / Dostupnost







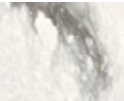

REX Etoile de Rex | Illusion | 120x240 | Glossy

80x180		60x120		120x120		120x240		Format (cm)	
9		6		6		6		Debljina (mm)	
Naturale	Glossy	Naturale	Glossy	Naturale	Glossy	Naturale	Glossy	Završna obrada	
								Protukliznost	
	109,49	124,17	94,84	118,56	96,11	115,46	118,69	134,81	MPC (€/m ²)
	824,95	935,55	714,60	893,31	724,14	869,93	894,23	1.015,70	MPC (Kn/m ²)
	605348	605352	605514	605521	605500	605507	605479	584522	Šif. / Dostupnost
	109,49	124,17	94,84	118,56	96,11	115,46	118,69	134,81	MPC (€/m ²)
	824,95	935,55	714,60	893,31	724,14	869,93	894,23	1.015,70	MPC (Kn/m ²)
	605350	605354	605516	605523	605502	605509	605481	605485	Šif. / Dostupnost
	109,49	124,17	94,84	118,56	96,11	115,46	118,69	134,81	MPC (€/m ²)
	824,95	935,55	714,60	893,31	724,14	869,93	894,23	1.015,70	MPC (Kn/m ²)
	605349	605353	605515	605522	605501	605508	605480	605484	Šif. / Dostupnost
	109,49	124,17	94,84	118,56	96,11	115,46	118,69	134,81	MPC (€/m ²)
	824,95	935,55	714,60	893,31	724,14	869,93	894,23	1.015,70	MPC (Kn/m ²)
	605351	605355	605517	605524	605503	605510	605482	605486	Šif. / Dostupnost
			94,84	118,56	96,11	115,46	118,69	134,81	MPC (€/m ²)
			714,60	893,31	724,14	869,93	894,23	1.015,70	MPC (Kn/m ²)
			605518	605525	605504	605511	605483	584524	Šif. / Dostupnost
			94,84	118,56	96,11	115,46	118,69	134,81	MPC (€/m ²)
			714,60	893,31	724,14	869,93	894,23	1.015,70	MPC (Kn/m ²)
			605519	605526	605505	605512	603359	584523	Šif. / Dostupnost



Pod REX Etoile de Rex | Gris | 120x240 | Glossy
 Zid REX Etoile de Rex | Symphonie | 120x240 | Naturale

	160x160		120x280		160x320		Format (cm)
	6		6		6		Debljina (mm)
	Naturale	Glossy	Naturale	Glossy	Naturale	Glossy	Završna obrada
							Protukliznost
	141,14	169,31	125,13	144,48	163,71	197,58	MPC (€/m ²)
	1.063,39	1.275,70	942,82	1.088,59	1.233,47	1.488,70	MPC (Kn/m ²)
	605471	605475	605463	605467	605455	605459	Šif. / Dostupnost
	141,14	169,31	125,13	144,48	163,71	197,58	MPC (€/m ²)
	1.063,39	1.275,70	942,82	1.088,59	1.233,47	1.488,70	MPC (Kn/m ²)
	605473	605477	605465	605469	605457	605461	Šif. / Dostupnost
	141,14	169,31	125,13	144,48	163,71	197,58	MPC (€/m ²)
	1.063,39	1.275,70	942,82	1.088,59	1.233,47	1.488,70	MPC (Kn/m ²)
	605472	605476	605464	605468	605456	605460	Šif. / Dostupnost
	141,14	169,31	125,13	144,48	163,71	197,58	MPC (€/m ²)
	1.063,39	1.275,70	942,82	1.088,59	1.233,47	1.488,70	MPC (Kn/m ²)
	605474	605478	605466	605470	605458	605462	Šif. / Dostupnost
							MPC (€/m ²)
							MPC (Kn/m ²)
							Šif. / Dostupnost
							MPC (€/m ²)
							MPC (Kn/m ²)
							Šif. / Dostupnost

REX

REVES DE REX

Inspirirana drevnom i profinjenom ljepotom alabastera, kolekcija Rêves de Rex spaja nježne nijanse boja i unosi dašak luksuza u prostor.

Pločice iz ove kolekcije same po sebi djeluju kao dekoracija na zidu ili podu i savršeno se uklapaju u bilo koju prostoriju doma.



REX Reves de Rex | Noisette | 120x240 | Naturele



Perle

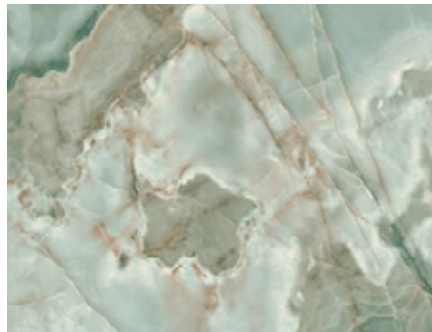

Jade

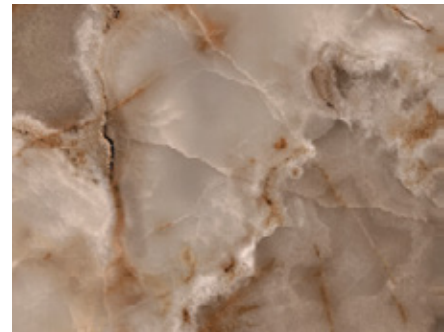

Choco



Noisette













Rose













Bleu

Prilikom narudžbe ploča velikih formata (120x240, 120x280, 160x320), naplaćuje se paleta. Po povratu palete, vrši se povrat novca.

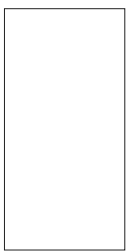
REX
REVES DE REX

										Format (cm)
		30x60		60x60		60x120		80x180		Debljina (mm)
		9		9		9		9		Završna obrada
		Naturale	Glossy	Naturale	Glossy	Naturale	Glossy	Naturale	Glossy	Protukliznost
	Perle	64,34	80,17	57,71	68,05	84,81	95,15	109,49	124,17	MPC (€/m ²)
		484,80	604,02	434,84	512,73	638,98	716,88	824,95	935,55	MPC (Kn/m ²)
		869007	869004	868955	868954	868974	868970	868999	868997	Šif. / Dostupnost
	Noisette	64,34	80,17	57,71	68,05	84,81	95,15	109,49	124,17	MPC (€/m ²)
		484,80	604,02	434,84	512,73	638,98	716,88	824,95	935,55	MPC (Kn/m ²)
		869008	869006	868958	868952	868971	868967	869000	868996	Šif. / Dostupnost
	Jade							109,54	124,13	MPC (€/m ²)
								825,31	935,25	MPC (Kn/m ²)
								1049551	1049549	Šif. / Dostupnost
	Rose							109,54	124,13	MPC (€/m ²)
								825,31	935,25	MPC (Kn/m ²)
								1049552	1049550	Šif. / Dostupnost
	Choco	64,34	80,17	57,71	68,05	84,81	95,15	109,49	124,17	MPC (€/m ²)
		484,80	604,02	434,84	512,73	638,98	716,88	824,95	935,55	MPC (Kn/m ²)
		869009	869003	868957	868953	868972	868968	869002	868995	Šif. / Dostupnost
	Bleu	64,34	80,17	57,71	68,05	84,81	95,15	109,49	124,17	MPC (€/m ²)
		484,80	604,02	434,84	512,73	638,98	716,88	824,95	935,55	MPC (Kn/m ²)
		869010	869005	868956	868479	868973	868969	869001	868998	Šif. / Dostupnost



												Format (cm)
		60x120		120x120		120x240		120x280		160x320		Debljina (mm)
		6		6		6		6		6		Završna obrada
		Naturale	Glossy	Naturale	Glossy	Naturale	Glossy	Naturale	Glossy	Naturale	Glossy	Protukliznost
	Perle	94,84	118,56	96,11	115,46	118,69	134,81	125,13	144,48	163,71	197,58	MPC (€/m ²)
		714,60	893,31	724,14	869,93	894,23	1.015,70	942,82	1.088,59	1.233,47	1.488,70	MPC (Kn/m ²)
		868925	868923	868899	868893	868907	868902	868910	860426	868919	868915	Šif. / Dostupnost
	Noisette	94,84	118,56	96,11	115,46	118,69	134,81	125,13	144,48	163,71	197,58	MPC (€/m ²)
		714,60	893,31	724,14	869,93	894,23	1.015,70	942,82	1.088,59	1.233,47	1.488,70	MPC (Kn/m ²)
		868924	868922	868897	868894	868906	868901	868912	868908	868920	868917	Šif. / Dostupnost
	Jade	94,84	118,61	95,51	114,86	118,11	134,21	124,55	143,90	163,76	197,56	MPC (€/m ²)
		714,54	893,65	719,63	865,43	889,93	1.011,21	938,42	1.084,23	1.233,84	1.488,49	MPC (Kn/m ²)
		1049543	1049541	1049527	1049525	1049531	1049529	1049535	1049533	1049539	1049537	Šif. / Dostupnost
	Rose	94,84	118,61	95,51	114,86	118,10	134,21	124,55	143,90	163,76	197,56	MPC (€/m ²)
		714,60	893,65	719,63	865,43	889,83	1.011,21	938,42	1.084,23	1.233,84	1.488,49	MPC (Kn/m ²)
		1049548	1049542	1049528	1049526	1049532	1049530	1049536	1049534	1049540	1049538	Šif. / Dostupnost
	Choco	94,84	118,56	96,11	115,46	118,69	134,81	125,13	144,48	163,71	197,58	MPC (€/m ²)
		714,60	893,31	724,14	869,93	894,23	1.015,70	942,82	1.088,59	1.233,47	1.488,70	MPC (Kn/m ²)
		868926	866674	868898	868895	868905	868903	868913	868909	868918	868916	Šif. / Dostupnost
	Bleu	94,84	118,56	96,11	115,46	118,69	134,81	125,13	144,48	163,71	197,58	MPC (€/m ²)
		714,60	893,31	724,14	869,93	894,23	1.015,70	942,82	1.088,59	1.233,47	1.488,70	MPC (Kn/m ²)
		868927	868514	868896	868892	868904	868900	868911	866922	868921	868914	Šif. / Dostupnost

CAESAR ALCHEMY



Pod CAESAR Alchemy | Navy | 80x80 | Naturale
Zid CAESAR Alchemy | Navy | 120x278 | Naturale

Prilikom narudžbe ploča velikih formata (120x278, 160x320),
naplaćuje se paleta. Po povratu palete, vrši se povrat novca.



Frozen



Argent

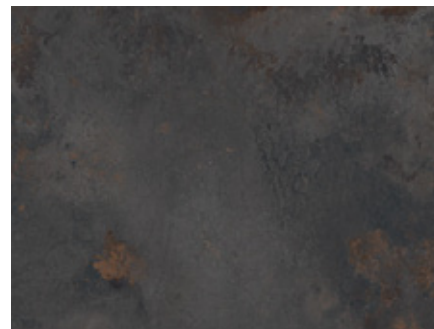

Magnet



Mint

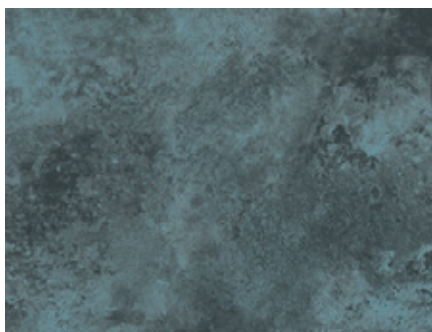

Navy

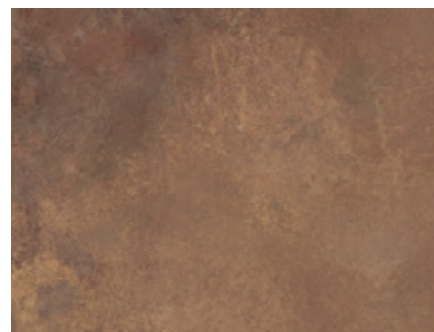

Copper

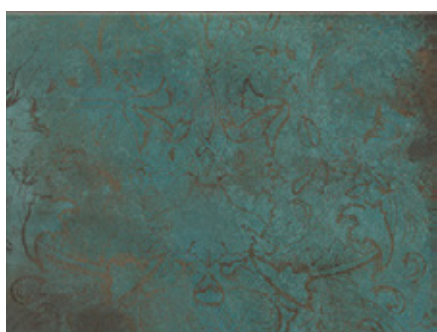

Mint Deco















Zanosna kolekcija Alchemy donosi pločice u bojama metala i njegovim oksidacijama nastalim zubom vremena.

Inspirirana je nepredvidivim širenjem mrlja na površini i iznenađujućim nijansama koje oksidacija stvara. Među njima se posebno ističe boja Mint.









CAESAR ALCHEMY

							
		30x30	30x60	60x60	40x80	80x80	Format (cm)
		9	9	9	9	9	Debljina (mm)
		Naturale	Naturale	Naturale	Naturale	Naturale	Završna obrada
		R9 A	R9 A	R9 A	R9 A	R9 A	Protukliznost
	Frozen				59,97	57,46	MPC (€/m ²)
					451,86	432,91	MPC (Kn/m ²)
						869134	887733
	Argent				59,97	57,46	MPC (€/m ²)
					451,86	432,91	MPC (Kn/m ²)
						887735	866817
	Magnet				59,97	57,46	MPC (€/m ²)
					451,86	432,91	MPC (Kn/m ²)
						868481	887643
	Mint	77,58	50,84	56,00	70,56	68,05	MPC (€/m ²)
		584,54	383,04	421,94	531,66	512,71	MPC (Kn/m ²)
		401880	549348	598330	860376	866838	Šif. / Dostupnost
	Navy				70,56	68,05	MPC (€/m ²)
					531,66	512,71	MPC (Kn/m ²)
						866816	869169
	Copper				70,56	68,05	MPC (€/m ²)
					531,66	512,71	MPC (Kn/m ²)
						887736	887734
	Mint Deco	107,99		97,09			MPC (€/m ²)
		813,63		731,50			MPC (Kn/m ²)
		401936		598334			Šif. / Dostupnost

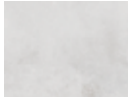

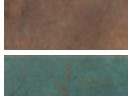

CAESAR Alchemy | Mint | 120x278 | Naturale

	60x120		120x120		120x278	160x320	60x60	Format (cm)
	9		9		6	6	20	Debljina (mm)
	Naturale	Lucidato	Naturale	Lucidato	Naturale	Naturale	Grip	Završna obrada
	R9 A		R9 A		R9	R9	R11 C	Protukliznost
	38,00	75,62	74,67	108,03				MPC (€/m ²)
	286,29	569,77	562,59	813,96				MPC (Kn/m ²)
	993739/☺	993745/☺	867692	993782				Šif. / Dostupnost
	38,00		74,67					MPC (€/m ²)
	286,29		562,59					MPC (Kn/m ²)
	993740/☺		869157					Šif. / Dostupnost
	38,00	75,62	74,67	108,03				MPC (€/m ²)
	286,29	569,77	562,59	813,96				MPC (Kn/m ²)
	993741/☺	993746/☺	860327	993783				Šif. / Dostupnost
	45,41	75,62	85,26	108,03	98,50	119,15	71,76	MPC (€/m ²)
	342,15	569,77	642,39	813,96	742,14	897,75	540,65	MPC (Kn/m ²)
	993744/☺	993748/☺	454084	993785	598333	598331	828491	Šif. / Dostupnost
	45,41	75,62	85,26	108,03	98,50			MPC (€/m ²)
	342,15	569,77	642,39	813,96	742,14			MPC (Kn/m ²)
	993743/☺	993747/☺	859650	993784	859351			Šif. / Dostupnost
	45,41		85,26		98,50			MPC (€/m ²)
	342,15		642,39		742,14			MPC (Kn/m ²)
	993742/☺		868480		887737			Šif. / Dostupnost
								MPC (€/m ²)
								MPC (Kn/m ²)
								Šif. / Dostupnost

CAESAR

RELATE FLAME



Zid CAESAR Relate Flame | Reef | 120x278 | Naturale

Prilikom narudžbe ploča velikih formata (120x278), naplaćuje se paleta. Po povratu palete, vrši se povrat novca.



Blizzard



Veil



Mine



Reef



Moss



Blaze

Inspiriran trendovima suvremene arhitekture, Relate Flame prikazuje transformacije materijala.

Zagasiće boje koje ova kolekcija nudi, ne mogu ostati nezamijećene bilo da se nalaze u vanjskim ili unutarnjim okruženjima. Prepustite se mašti uz Relate.

CAESAR RELATE FLAME								
		30x30	30x60	60x60	60x120	120x120	120x278	
		9	9	9	9	9	6	Debljina (mm)
		Naturale	Naturale	Naturale	Naturale	Naturale	Naturale	Završna obrada
		R10 A	R10 A	R10 A	R10 A	R10 A	R9	Protukliznost
	Blizzard		40,25	45,41	38,00	74,67	98,50	MPC (€/m ²)
			303,24	342,14	286,29	562,59	742,14	MPC (Kn/m ²)
			598250	598229	598240/☺	598260	598264	Šif. / Dostupnost
	Veil		40,25	45,41	38,00	74,67		MPC (€/m ²)
			303,24	342,14	286,29	562,59		MPC (Kn/m ²)
			598251	598230	598242/☺	598261		Šif. / Dostupnost
	Mine		40,25	45,41	38,00	74,67	98,50	MPC (€/m ²)
			303,24	342,14	286,29	562,59	742,14	MPC (Kn/m ²)
			598255	598233	598245/☺	598262	598265	Šif. / Dostupnost
	Reef	77,58		56,00	38,00	85,26	98,50	MPC (€/m ²)
		584,54		421,94	286,29	642,39	742,14	MPC (Kn/m ²)
		598258		584528	887975/☺	887903	586714	Šif. / Dostupnost
	Moss	77,58		56,00			98,50	MPC (€/m ²)
		584,54		421,94			742,14	MPC (Kn/m ²)
		598259		598235			598266	Šif. / Dostupnost
	Blaze	77,58		56,00			98,50	MPC (€/m ²)
		584,54		421,94			742,14	MPC (Kn/m ²)
		598257		598236			586713	Šif. / Dostupnost

CERIM MATCH-UP



Pod CERIM Match Up | Decoro Shapes
Zid CERIM Match Up | Earl Grey Mix | 120x280 | Glossy

Prilikom narudžbe ploča velikih formata (120x240, 120x280), naplaćuje se paleta. Po povratu palete, vrši se povrat novca.

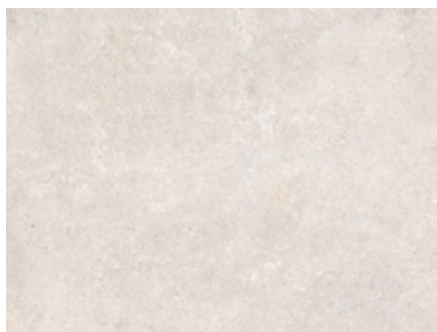

Sugar



Cookie

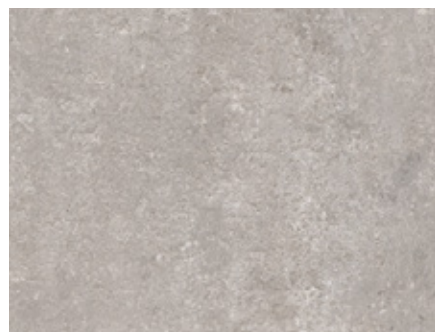

Earl grey

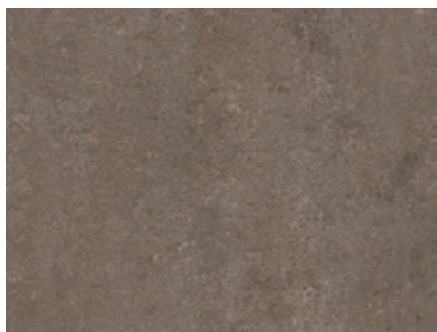

Coffee



Cinnamon

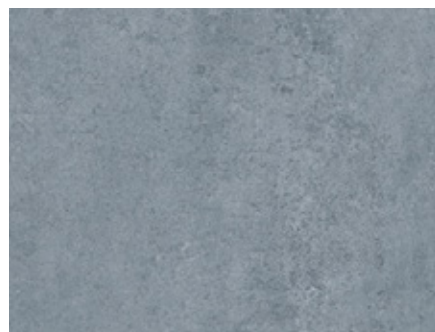

Blueberry

Match Up je kolekcija koja se ističe po različitim kontrastima boja. Kolekcija ima namjerne fleke čija boja može varirati, ovisno o pozadinskoj boji.

Ova je kolekcija pravi primjer moderne pločice koja će svojim zanimljivim vizualom upotpuniti svaki prostor.

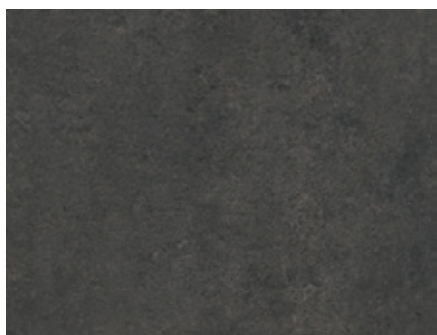

Liquorice

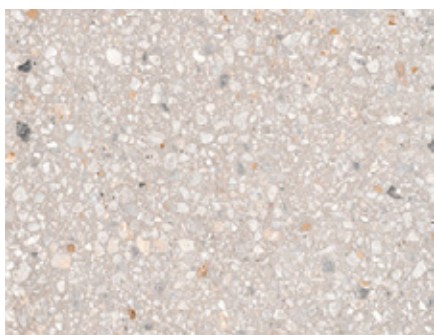

Sugar Mix



Cookie Mix

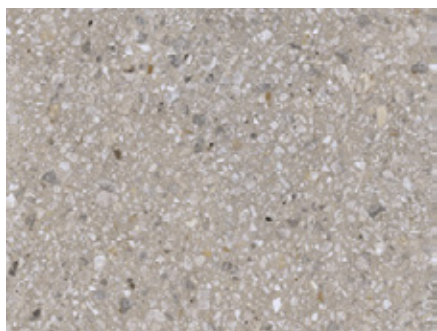

Earl grey Mix

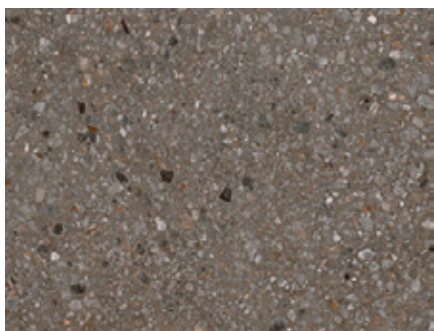



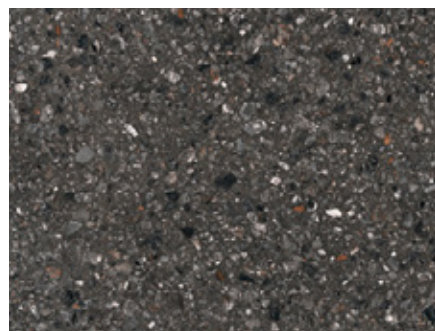









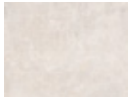
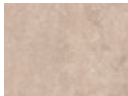
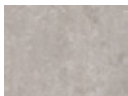

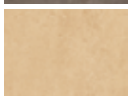

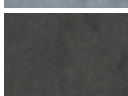





Coffee Mix

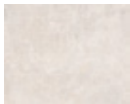

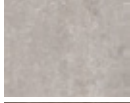
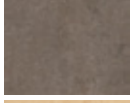
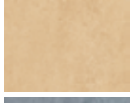
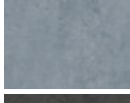
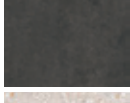
Liquorice Mix

CERIM MATCH-UP

								
		30x60	60x60	60x120		Format (cm)		
		9	9	9		6	Debljina (mm)	
		Comfort	Comfort	Comfort	Grip	Comfort	Glossy	Završna obrada
		R10 B	R10 B	R10 B	R11 B	R10 B		Protukliznost
	Sugar	42,89	48,70	71,28	71,28	69,95		MPC (€/m ²)
		323,13	366,96	537,04	537,04	527,03		MPC (Kn/m ²)
		888312	888278	888302	888290	888272		Šif. / Dostupnost
	Cookie	42,89	48,70	71,28	71,28	69,95		MPC (€/m ²)
		323,13	366,96	537,04	537,04	527,03		MPC (Kn/m ²)
		888313	888279	888303	888291	888273		Šif. / Dostupnost
	Earl grey	42,89	38,96	57,02	71,28	69,95		MPC (€/m ²)
		323,13	293,57	429,63	537,04	527,03		MPC (Kn/m ²)
		888315	888281/L	888305/L	888293	888274		Šif. / Dostupnost
	Coffee	42,89	48,70	71,28	71,28			MPC (€/m ²)
		323,13	366,96	537,04	537,04			MPC (Kn/m ²)
		888314	888280	888304	888292			Šif. / Dostupnost
	Cinnamon	42,89	48,70	71,28	71,28			MPC (€/m ²)
		323,13	366,96	537,04	537,04			MPC (Kn/m ²)
		888317	888283	888307	888295			Šif. / Dostupnost
	Blueberry	42,89	48,70	71,28	71,28			MPC (€/m ²)
		323,13	366,96	537,04	537,04			MPC (Kn/m ²)
		888318	888284	888308	888296			Šif. / Dostupnost
	Liquorice	42,89	48,70	71,28	71,28			MPC (€/m ²)
		323,13	366,96	537,04	537,04			MPC (Kn/m ²)
		888316	888282	888306	888294			Šif. / Dostupnost
	Sugar Mix	42,89	48,70	71,28	71,28	69,95	90,29	MPC (€/m ²)
		323,13	366,96	537,04	537,04	527,03	680,30	MPC (Kn/m ²)
		888319	888285	887156	888297	888275	888271	Šif. / Dostupnost
	Cookie Mix	42,89	48,70	71,28	71,28	69,95	90,29	MPC (€/m ²)
		323,13	366,96	537,04	537,04	527,03	680,30	MPC (Kn/m ²)
		888320	888286	888309	888298	888276	888269	Šif. / Dostupnost
	Earl grey Mix	42,89	48,70	57,02	71,28	69,95	90,29	MPC (€/m ²)
		323,13	366,96	429,63	537,04	527,03	680,30	MPC (Kn/m ²)
		888322	888288	887717/L	888300	888277	888270	Šif. / Dostupnost
	Coffee Mix	42,89	48,70	71,28	71,28			MPC (€/m ²)
		323,13	366,96	537,04	537,04			MPC (Kn/m ²)
		888321	888287	888310	888299			Šif. / Dostupnost
	Liquorice Mix	42,89	48,70	71,28	71,28			MPC (€/m ²)
		323,13	366,96	537,04	537,04			MPC (Kn/m ²)
		888323	888289	888311	888301			Šif. / Dostupnost

	120x120		120x240		120x280		60x120	Format (cm)
	6		6		6		20	Debljina (mm)
	Comfort	Glossy	Comfort	Glossy	Comfort	Glossy	Grip	Završna obrada
	R10 B		R10 B		R10 B		R11 C	Protukliznost
	96,11		118,69		125,13		95,15	MPC (€/m ²)
	724,14		894,23		942,82		716,88	MPC (Kn/m ²)
	888245		888254		888263		888324	Šif. / Dostupnost
	96,11		118,69		125,13		95,15	MPC (€/m ²)
	724,14		894,23		942,82		716,88	MPC (Kn/m ²)
	888246		888255		888264		888325	Šif. / Dostupnost
	96,11		118,69		125,13		95,15	MPC (€/m ²)
	724,14		894,23		942,82		716,88	MPC (Kn/m ²)
	888247		888256		888265		888326	Šif. / Dostupnost
								MPC (€/m ²)
								MPC (Kn/m ²)
								Šif. / Dostupnost
								MPC (€/m ²)
								MPC (Kn/m ²)
								Šif. / Dostupnost
								MPC (€/m ²)
								MPC (Kn/m ²)
								Šif. / Dostupnost
								MPC (€/m ²)
								MPC (Kn/m ²)
								Šif. / Dostupnost
	96,11	115,46	118,69	134,81	125,13	144,48	95,15	MPC (€/m ²)
	724,14	869,93	894,23	1.015,70	942,82	1.088,59	716,88	MPC (Kn/m ²)
	888248	888242	888257	888251	888266	888260	888327	Šif. / Dostupnost
	96,11	115,46	118,69	134,81	125,13	144,48	95,15	MPC (€/m ²)
	724,14	869,93	894,23	1.015,70	942,82	1.088,59	716,88	MPC (Kn/m ²)
	888249	888243	888258	888252	888267	888261	888328	Šif. / Dostupnost
	96,11	115,46	118,69	134,81	125,13	144,48	95,15	MPC (€/m ²)
	724,14	869,93	894,23	1.015,70	942,82	1.088,59	716,88	MPC (Kn/m ²)
	888250	888244	888259	888253	888268	888262	888329	Šif. / Dostupnost
								MPC (€/m ²)
								MPC (Kn/m ²)
								Šif. / Dostupnost
								MPC (€/m ²)
								MPC (Kn/m ²)
								Šif. / Dostupnost

COTTO D'ESTE METAL



COTTO D'ESTE Metal | Corten | 100x300 | Naturale

Prilikom narudžbe ploča velikih formata (100x300),
naplaćuje se paleta. Po povratu palete, vrši se povrat novca.



COTTO D'ESTE Metal | Iron | 100x100 | Naturale

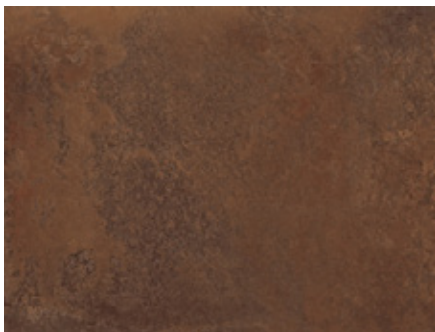

Corten

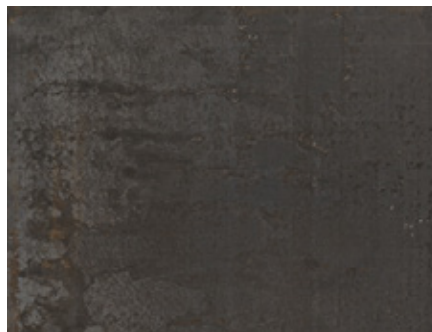



Iron

Snažan identitet metala predstavljen je u dvije boje i dvije dimenzije. Na površini pločica imitirani su sitni detalji koji se mogu pronaći samo na hrđi i željezu.

Obje dimenzije omogućavaju kontinuitet i ljepotu površine koja nije prekinuta fugom.

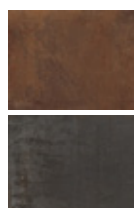
COTTO D'ESTE METAL



				
		100x100	100x300	Format (cm)
		5,5	5,5	Debljina (mm)
		Naturale	Naturale	Završna obrada
		R9	R9	Protukliznost
Corten		93,07	93,07	MPC (€/m ²)
		701,24	701,24	MPC (Kn/m ²)
		390579	390580	Šif. / Dostupnost
Iron		93,07	93,07	MPC (€/m ²)
		701,24	701,24	MPC (Kn/m ²)
		390581	390582	Šif. / Dostupnost



IMOLA TUBE



IMOLA Tube | N | 60x120 | Naturale

Prilikom narudžbe ploča velikih formata (120x260), naplaćuje se paleta za koju se ne vrši povrat novca.

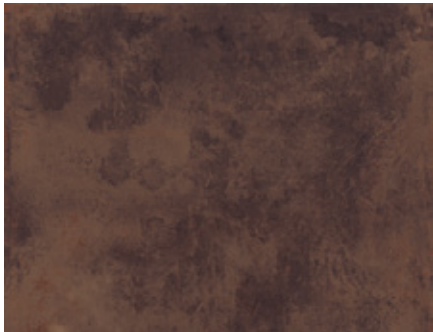

T



W



G

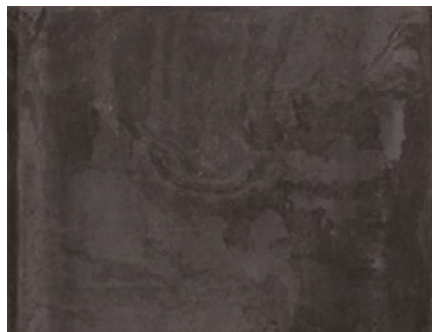

N











Imola Tube daje osjećaj prostora
suvremenih metropola.

Prepoznatljive boje metala i šest dimenzija
u kojima dolaze, savršen su izbor za
ljubitelje industrijskog, modernog stila.

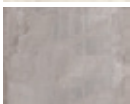

IMOLA Tube | Dekor Camden | 120x260

IMOLA TUBE

								
		60x60	60x120	120x120	60x120	120x120	120x260	Format (cm)
		10	10	10	6,5	6,5	6,5	Debljina (mm)
		Naturale	Naturale	Naturale	Naturale	Naturale	Naturale	Završna obrada
		R9 A	R9 A	R9 A	R9 A	R9 A	R9 A	Protukliznost
	T	48,91	62,65	87,59	70,56	86,00	107,50	MPC (€/m ²)
		368,48	472,01	659,95	531,66	647,98	809,98	MPC (Kn/m ²)
		551778	551774	551766	847413	551770	551762	Šif. / Dostupnost
	W	48,91	62,65	87,59	70,56	86,00	107,50	MPC (€/m ²)
		368,48	472,01	659,95	531,66	647,98	809,98	MPC (Kn/m ²)
		551779	551775	551767	847414	551771	551763	Šif. / Dostupnost
	G	48,91	62,65	87,59	70,56	86,00	107,50	MPC (€/m ²)
		368,48	472,01	659,95	531,66	647,98	809,98	MPC (Kn/m ²)
		551776	551772	551764	847411	551768	551760	Šif. / Dostupnost
	N	48,91	62,65	87,59	70,56	86,00	107,50	MPC (€/m ²)
		368,48	472,01	659,95	531,66	647,98	809,98	MPC (Kn/m ²)
		551777	551773	551765	847412	551769	551761	Šif. / Dostupnost

LEONARDO **OVERCOME**





W



GB



G

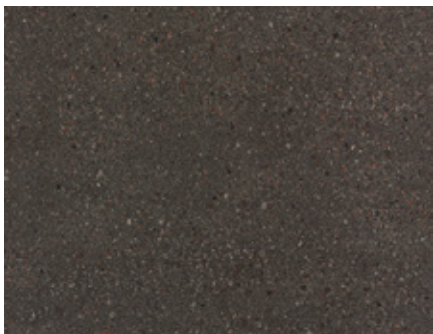

DG

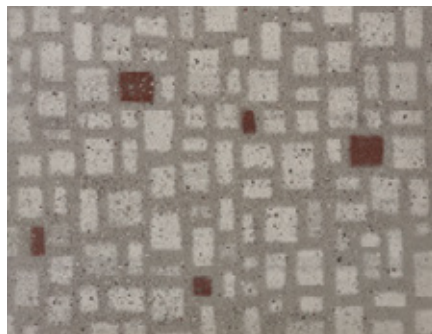

MAP RED









LETTERS

Overcome kolekcija ima dašak industrijskog stila, a posebno kod nje je što su na površini pločice razbacana nasumična zrnca i točkice koje se pojavljuju u rasponu od svijetlih do tamnih nijansi i ističu se u odnosu na boju pozadine.

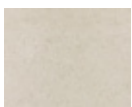
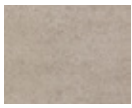
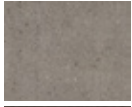
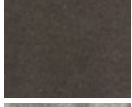

LEONARDO OVERCOME

											
		30x60	60x60		60x120		120x120		Format (cm)		
		10,5	10,5		10,5		10,5		Debljina (mm)		
		Naturale	Naturale	Lev.Luc.L	Grip	Naturale	Lev.Luc.L	Grip	Naturale	Lev.Luc.L	Završna obrada
		R10 A	R10 A		R10 A	R10 A		R11 C	R10 A		Protukliznost
	W	61,75	60,69	84,34	63,78	73,75	98,25	76,80	99,98	126,83	MPC (€/m ²)
		465,24	457,30	635,45	480,56	555,65	740,28	578,61	753,31	955,60	MPC (Kn/m ²)
		847126	847114	847122	847118	847100	847110	847106	847090	847096	Šif. / Dostupnost
	GB	54,86	54,52	78,40	57,65	67,69	92,27	70,74	92,06	119,13	MPC (€/m ²)
		413,36	410,78	590,69	434,34	510,01	695,23	532,98	693,66	897,55	MPC (Kn/m ²)
		847129	847117	847125	847121	847103	847113	847109	847093	847099	Šif. / Dostupnost
	G	54,86	54,52	78,40	57,65	67,69	92,27	70,74	92,06	119,13	MPC (€/m ²)
		413,36	410,78	590,69	434,34	510,01	695,23	532,98	693,66	897,55	MPC (Kn/m ²)
		847128	847116	847124	847120	847102	847112	847108	847092	847098	Šif. / Dostupnost
	DG	54,86	54,52	78,40	57,65	67,69	92,27	70,74	92,06	119,13	MPC (€/m ²)
		413,36	410,78	590,69	434,34	510,01	695,23	532,98	693,66	897,55	MPC (Kn/m ²)
		847127	847115	847123	847119	847101	847111	847107	847091	847097	Šif. / Dostupnost
	MAP RED					75,22			92,06		MPC (€/m ²)
						566,78			693,66		MPC (Kn/m ²)
						847105			847095		Šif. / Dostupnost
	LETTERS					75,22			92,06		MPC (€/m ²)
						566,78			693,66		MPC (Kn/m ²)
						847104			847094		Šif. / Dostupnost

CAESAR AUTORE



CAESAR Autore | Giudecca | 30x60,60x60 | Naturale



Trevi

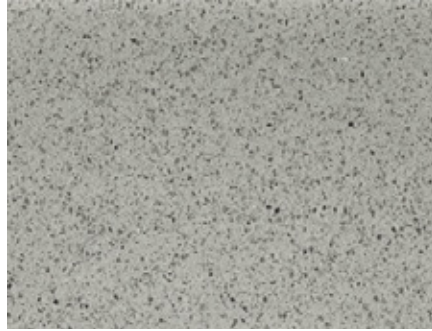

Giudecca



Rimini

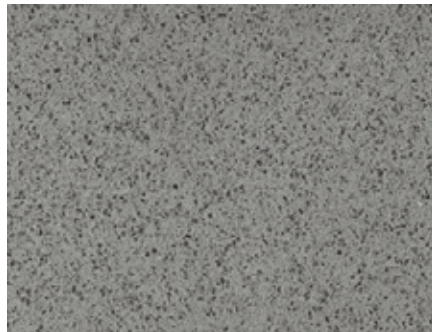

Rivoli







Iz ljubavi prema materijalima, nastaje kolekcija Autore.

Bogatstvo detalja terazza plijeni poglede te ove pločice postaju neizbježni klasik suvremenog dizajna.

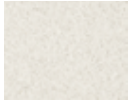
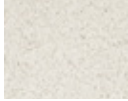

CAESAR Autore | Rivoli | 60x60 | Naturale

**CAESAR
AUTORE**

					
		30x60	60x60	120x120	Format (cm)
		9	9	9	Debljina (mm)
		Naturale	Naturale	Naturale	Završna obrada
		R9	R9	R9	Protukliznost
	Trevi	40,25	45,41	74,67	MPC (€/m ²)
		303,24	342,14	562,59	MPC (Kn/m ²)
		597991	584148	554154	Šif. / Dostupnost
	Rimini	40,25	45,41		MPC (€/m ²)
		303,24	342,14		MPC (Kn/m ²)
		597988	597375		Šif. / Dostupnost
	Giudecca	40,25	45,41		MPC (€/m ²)
		303,24	342,14		MPC (Kn/m ²)
		597990	597984		Šif. / Dostupnost
	Rivoli	40,25	45,41		MPC (€/m ²)
		303,24	342,14		MPC (Kn/m ²)
		597989	597985		Šif. / Dostupnost

BLUSTYLE **YOSEMITE**



BLUSTYLE Yosemite | Lake | 60x60 | Naturale

Kolekcija Yosemite željela je čovjeka ponovno povezati s prirodom i učiniti da se uvijek osjeća kao da je u kontaktu s njom, ovoga puta preko kamena. Inspirirana vapnenačkim stijenama, Yosemite donosi pločice s izraženim žilama i prekrasnim nijansama. Ove pločice mogu jednako dobro pristajati u rustikalnim i modernim uređenjima.



BLUSTYLE Yosemite | Rock | 90x90 | Fiammata



Lake





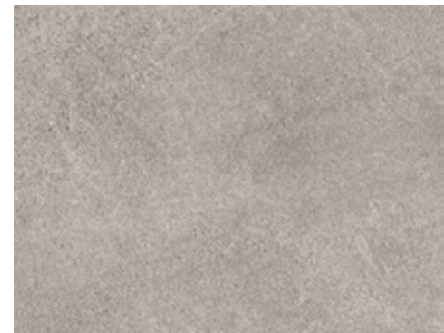



Park



Rock

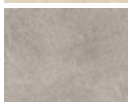

**BLUSTYLE
YOSEMITE**

		 30x60 9,5			 60x60 9,5			 90x90 9,5		 60x60 20	Format (cm)
		Naturale	Lappata	Fiammata	Naturale	Lappata	Fiammata	Naturale	Lappata	Bocciard.	Debljina (mm)
		R10 B		R11 C	R10 B		R11 C	R10 B		R11 C	Završna obrada
	Lake	45,65	51,02	36,84	36,84	51,02	36,84	50,21	51,43	80,83	MPC (€/m ²)
		346,93	384,39	277,54	277,54	384,39	277,54	378,30	387,53	608,98	MPC (Kn/m ²)
		603212	603217	603213/Ⓛ	597423/Ⓛ	603226	597421/Ⓛ	603234	603237	597872	Šif. / Dostupnost
	Park	43,60	48,57	34,88	34,88	48,57	34,88	50,21	51,43	78,38	MPC (€/m ²)
		328,48	365,94	262,78	262,78	365,94	262,78	378,30	387,53	590,53	MPC (Kn/m ²)
		603214	603218	603215/Ⓛ	603223/Ⓛ	603227	603224/Ⓛ	603235	603238	603232	Šif. / Dostupnost
	Rock	43,60	48,57	34,88	34,88	48,57	34,88	50,21	51,43	78,38	MPC (€/m ²)
		328,48	365,94	262,78	262,78	365,94	262,78	378,30	387,53	590,53	MPC (Kn/m ²)
		584532	603219	603216/Ⓛ	584531/Ⓛ	603228	603225/Ⓛ	603236	603239	603233	Šif. / Dostupnost

CAESAR PORTRAITS

Boje prirodnog kamena, proširene s nijansama plave, glavna su vodilja ove kolekcije.

Svaki kamen se razlikuje jedan od drugoga, no ono što im je zajedničko je njihova ljepota. Kolekcija Portraits vjerno prenosi dojam kamena u bilo koji prostor.



CAESAR Portraits | Comblanchien, Kirkby | 30x60 | Naturale

Prilikom narudžbe ploča velikih formata (120x278, 160x320), naplaćuje se paleta. Po povratu palete, vrši se povrat novca.



Comblanchien



Faro



Tozeur



Versilia

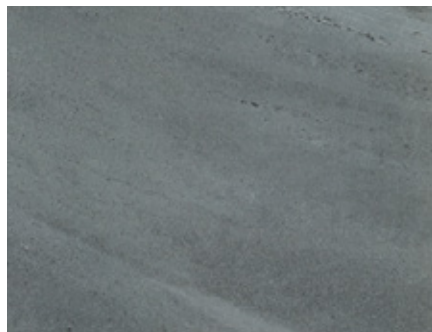

Kirkby



Stromboli

**CAESAR
PORTRAITS**

		30x60	60x60	60x120	120x120	120x278	160x320	60x60	60x120	Format (cm)	
		9	9	9	9	6	6	20	20	Debljina (mm)	
		Naturale	Naturale	Struktur.	Naturale	Naturale	Naturale	Struktur.	Struktur.	Završna obrada	
		R9	R9	R11 C	R9	R9	R9	R11 C	R11 C	Protukliznost	
	Comblanchien	40,25	45,41	45,41	38,00	74,67	98,50		71,76	83,80	MPC (€/m ²)
		303,24	342,14	342,14	286,29	562,59	742,14		540,65	631,41	MPC (Kn/m ²)
		492959	597397	598220	492954/☆	492973	598225		598355	598356	Šif. / Dostupnost
	Faro	40,25	45,41	45,41	38,00	74,67	98,50	108,56	71,76	83,80	MPC (€/m ²)
		303,24	342,14	342,14	286,29	562,59	742,14	817,95	540,65	631,41	MPC (Kn/m ²)
		492956	596720	598217	492951/☆	492971	598223	554356	492900	492905	Šif. / Dostupnost
	Tozeur	40,25	45,41								MPC (€/m ²)
		303,24	342,14								MPC (Kn/m ²)
		492960	598214								Šif. / Dostupnost
	Versilia	40,25	45,41		38,00				71,76	83,80	MPC (€/m ²)
		303,24	342,14		286,29				540,65	631,41	MPC (Kn/m ²)
		492958	598212		492952/☆				492901	492903	Šif. / Dostupnost
	Kirkby	40,25	45,41		38,00	74,67	98,50	108,56		83,80	MPC (€/m ²)
		303,24	342,14		286,29	562,59	742,14	817,95		631,41	MPC (Kn/m ²)
		492957	598213		492953/☆	492972	598224	554357		492904	Šif. / Dostupnost
	Stromboli	40,25	45,41								MPC (€/m ²)
		303,24	342,14								MPC (Kn/m ²)
		492961	598215								Šif. / Dostupnost

CAESAR SHAPES OF ITALY



Pod CAESAR Shapes Of Italy | Iulia | 80x80 | Naturale
Zid CAESAR Shapes Of Italy | Iulia | 120x278 | Naturale
Dekor Iulia Trama | 30x30 | Naturale

Prilikom narudžbe ploča velikih formata (120x278),
naplaćuje se paleta. Po povratu palete, vrši se povrat novca.



Beola Reale

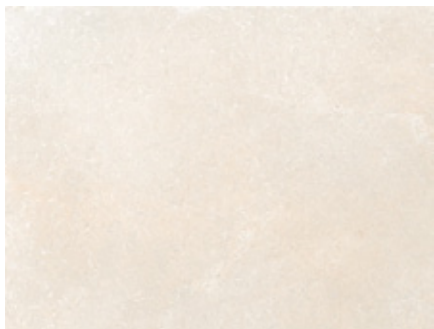

Itria



Monviso



Sestriere



Iulia

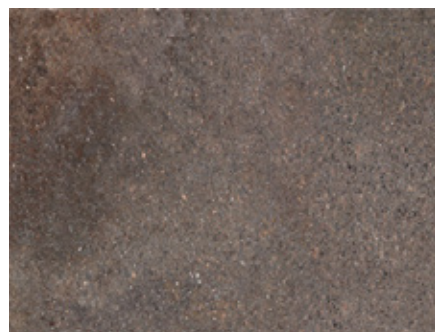

Lavis

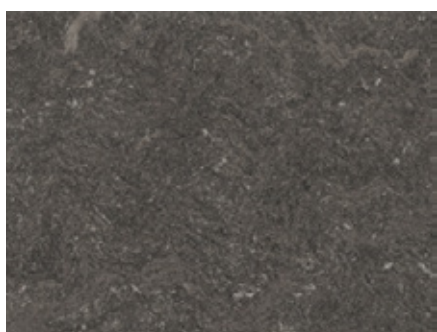

Gardena

Italija je zemlja s bogatom povijesti i arhitekturom te je ova kolekcija, inspirirana kamenom korištenim u gradnji, nastojala prenijeti sedam različitih vrsta kamena.

Osim što kolekcija nudi sedam dizajna pločica, tu je i vrlo širok raspon dimenzija koje se mogu kombinirati pa se na taj način postiže jedinstvenost.









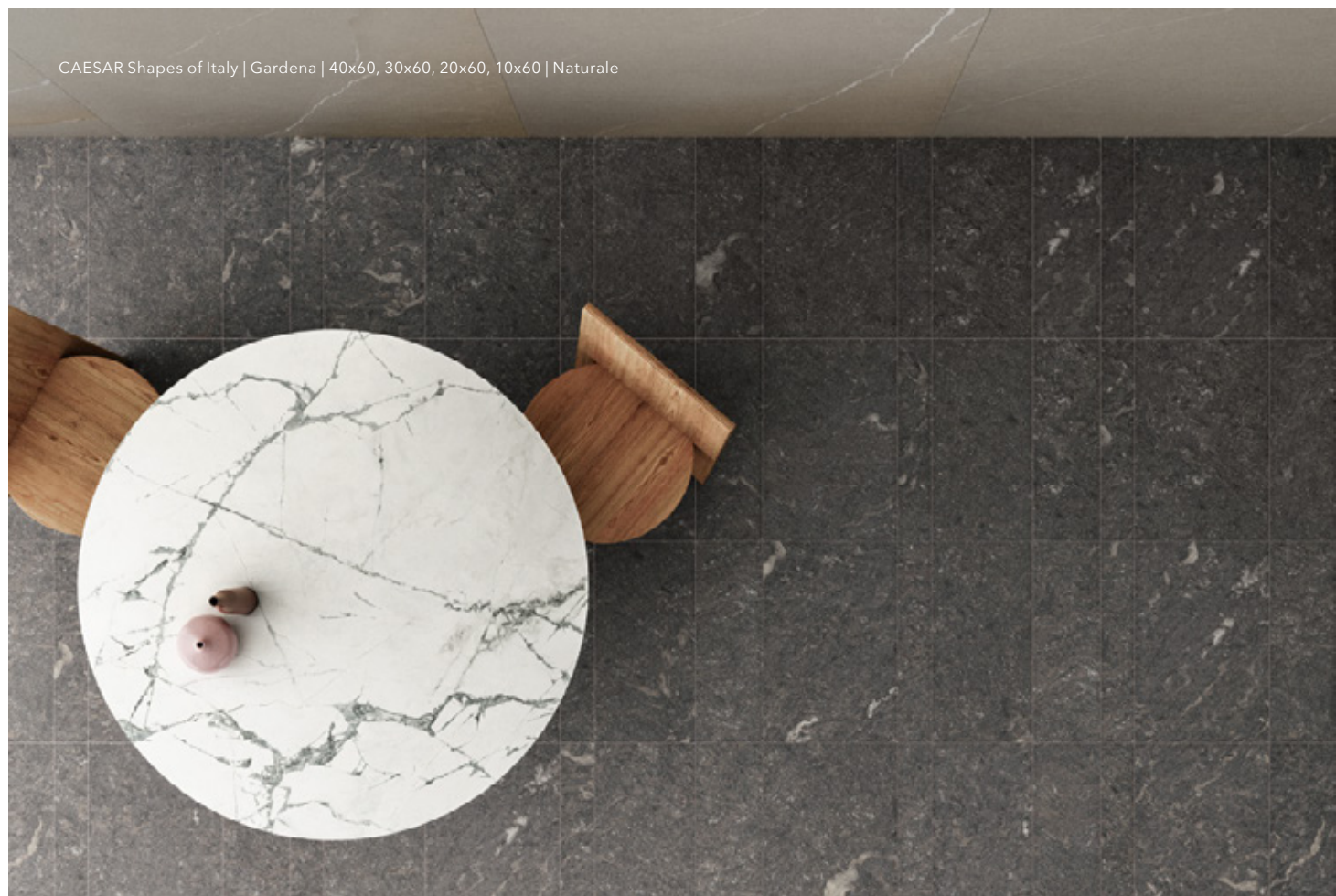







**CAESAR
SHAPES
OF ITALY**

		22,5x22,5	22,5x45,3	10x60	20x60	30x60	40x60	60x60	Format (cm)	
		9	9	9	9	9	9	9	Debljina (mm)	
		Struktur.	Struktur.	Naturale	Naturale	Naturale	Struktur.	Naturale	Završna obrada	
		R11 C	R11 C	R10 B	R10 B	R10 B	R11 C	R10 B	Protukliznost	
	Beola Reale			55,87	55,87	40,25		55,87	45,41	MPC (€/m ²)
				420,95	420,95	303,24		420,95	342,14	MPC (Kn/m ²)
				854961	854955	854949		854945	854925	Šif. / Dostupnost
	Itria	34,69	34,69	55,87	55,87	40,25	33,63	55,87	45,41	MPC (€/m ²)
		261,35	261,35	420,95	420,95	303,24	253,36	420,95	342,14	MPC (Kn/m ²)
		854985	854981	854962	854956	854950	854971	854943	854926	Šif. / Dostupnost
	Monviso	34,69	34,69				33,63			MPC (€/m ²)
		261,35	261,35				253,36			MPC (Kn/m ²)
		854986	854982				854972			Šif. / Dostupnost
	Sestriere			55,87	55,87	40,25		55,87	45,41	MPC (€/m ²)
				420,95	420,95	303,24		420,95	342,14	MPC (Kn/m ²)
				854963	854957	854951		854944	854927	Šif. / Dostupnost
	Iulia	34,69	34,69	55,87	55,87	40,25	33,63	55,87	45,41	MPC (€/m ²)
		261,35	261,35	420,95	420,95	303,24	253,36	420,95	342,14	MPC (Kn/m ²)
		854987	854983	854965	854959	854954	854973	854947	854929	Šif. / Dostupnost
	Lavis	34,69	34,69	55,87	55,87	40,25	33,63	55,87	45,41	MPC (€/m ²)
		261,35	261,35	420,95	420,95	303,24	253,36	420,95	342,14	MPC (Kn/m ²)
		854988	854984	854966	854960	854952	854974	854948	854930	Šif. / Dostupnost
	Gardena			55,87	55,87	40,25	33,63	55,87	45,41	MPC (€/m ²)
				420,95	420,95	303,24	253,36	420,95	342,14	MPC (Kn/m ²)
				854964	854958	854953	854975	854946	854928	Šif. / Dostupnost



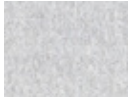
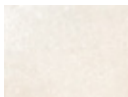

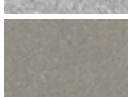
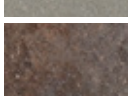
CAESAR Shapes of Italy | Lavis | 120x120 | Naturale

									Format (cm)
	60x120	80x80	120x120	120x278	60x60	80x80	60x120	120x120	Format (cm)
	9	9	9	6	20	20	20	20	Debljina (mm)
	Naturale	Grip	Naturale	Naturale	Struktur.	Struktur.	Struktur.	Struktur.	Završna obrada
	R10 B	R11 C	R10 B	R10 B	R11 C	R11 C	R11 C	R11 C	Protukliznost
	38,00	39,11		74,67			83,80	81,73	MPC (€/m ²)
	286,29	294,67		562,59			631,41	615,80	MPC (Kn/m ²)
	854931/☼	854937/☼		854968			854989	854993	Šif. / Dostupnost
	38,00	39,11	57,46			83,80			MPC (€/m ²)
	286,29	294,67	432,91			631,41			MPC (Kn/m ²)
	854932/☼	854938/☼	854921			887113			Šif. / Dostupnost
						83,80			MPC (€/m ²)
						631,41			MPC (Kn/m ²)
						887115			Šif. / Dostupnost
	38,00	39,11	57,46			83,80			MPC (€/m ²)
	286,29	294,67	432,91			631,41			MPC (Kn/m ²)
	854933/☼	854939/☼	854922			887114			Šif. / Dostupnost
	38,00	39,11	57,46	74,67	98,50		83,80	81,73	MPC (€/m ²)
	286,29	294,67	432,91	562,59	742,14		631,41	615,80	MPC (Kn/m ²)
	854934/☼	854941/☼	854923	854969	854967		854990	854994	Šif. / Dostupnost
	38,00	39,11		74,67		71,76	83,80		MPC (€/m ²)
	286,29	294,67		562,59		540,65	631,41		MPC (Kn/m ²)
	854935/☼	854942/☼		854970		887907	854991		Šif. / Dostupnost
	38,00	39,11	57,46				83,80	83,80	MPC (€/m ²)
	286,29	294,67	432,91				631,41	631,41	MPC (Kn/m ²)
	854936/☼	854940/☼	854924				887116	854992	Šif. / Dostupnost

CDC SENSI

Ovo je kolekcija koja crpi inspiraciju iz nevjerojatne snage prirode i boja koje nam priroda daje. Zemlja i pijesak ukomponirani na površini kamena stvaraju vizualni sklad.

Četiri različita dizajna pločica dolazi u sedam različitih dimenzija te čak pet boja, a za one koji žele nešto drugačije, tu je i kombinacija mozaika.



Pod CASA DOLCE CASA Sensi | Taupe | 120x240 | Sand
Zid CASA DOLCE CASA Sensi | White | 120x280 | Fossil

Prilikom narudžbe ploča velikih formata (120x240, 120x280), naplaćuje se paleta. Po povratu palete, vrši se povrat novca.



**CDC
SENSI**

		40x80				80x80				Format (cm)
		9				9				Debljina (mm)
		Dust	Lithos	Sand	Fossil	Dust	Lithos	Sand	Fossil	Završna obrada
		R9	R10 B	R11 C	R9	R9	R10 B	R11 C	R9	Protukliznost
	White	75,65	75,65	75,65	75,65	97,04	97,04	97,04	97,04	MPC (€/m ²)
		569,97	569,97	569,97	569,97	731,18	731,18	731,18	731,18	MPC (Kn/m ²)
		850023	850025	850024	850026	850048	850050	850049	850051	Šif. / Dostupnost
	Ivory	75,65	75,65	75,65	75,65	97,04	97,04	97,04	97,04	MPC (€/m ²)
		569,97	569,97	569,97	569,97	731,18	731,18	731,18	731,18	MPC (Kn/m ²)
		850028	850030	850029	850031	850053	850055	850054	850056	Šif. / Dostupnost
	Grey	75,65	75,65	75,65	75,65	97,04	97,04	97,04	97,04	MPC (€/m ²)
		569,97	569,97	569,97	569,97	731,18	731,18	731,18	731,18	MPC (Kn/m ²)
		850033	850035	850034	850036	850058	850060	850059	850062	Šif. / Dostupnost
	Taupe	75,65	75,65	75,65	75,65	97,04	97,04	97,04	97,04	MPC (€/m ²)
		569,97	569,97	569,97	569,97	731,18	731,18	731,18	731,18	MPC (Kn/m ²)
		850038	850040	850039	850041	850063	850065	850064	850066	Šif. / Dostupnost
	Brown	75,65	75,65	75,65	75,65	97,04	97,04	97,04	97,04	MPC (€/m ²)
		569,97	569,97	569,97	569,97	731,18	731,18	731,18	731,18	MPC (Kn/m ²)
		850043	850045	850044	850046	850068	850070	850069	850071	Šif. / Dostupnost

		60x120				60x120				Format (cm)
		9				6				Debljina (mm)
		Dust	Lithos	Sand	Fossil	Dust	Lithos	Sand	Fossil	Završna obrada
		R9	R10 B	R11 C	R9	R9	R10 B	R9	R9	Protukliznost
		103,76	103,76	103,76	103,76	94,84	94,84	94,84	94,84	MPC (€/m ²)
		782,04	782,04	782,04	782,04	714,60	714,60	714,60	714,60	MPC (Kn/m ²)
		849998	850000	849999	850001	849973	849993	849988	849974	Šif. / Dostupnost
		103,76	103,76	103,76	103,76	94,84	94,84	94,84	94,84	MPC (€/m ²)
		782,04	782,04	782,04	782,04	714,60	714,60	714,60	714,60	MPC (Kn/m ²)
		850003	850005	850004	850006	849975	849994	849989	849976	Šif. / Dostupnost
		103,76	103,76	103,76	103,76	94,84	94,84	94,84	94,84	MPC (€/m ²)
		782,04	782,04	782,04	782,04	714,60	714,60	714,60	714,60	MPC (Kn/m ²)
		850008	850010	850009	850011	849977	849995	849990	849978	Šif. / Dostupnost
		103,76	103,76	103,76	103,76	94,84	94,84	94,84	94,84	MPC (€/m ²)
		782,04	782,04	782,04	782,04	714,60	714,60	714,60	714,60	MPC (Kn/m ²)
		850013	850015	850014	850016	849979	849996	849991	849980	Šif. / Dostupnost
		103,76	103,76	103,76	103,76	94,84	94,84	94,84	94,84	MPC (€/m ²)
		782,04	782,04	782,04	782,04	714,60	714,60	714,60	714,60	MPC (Kn/m ²)
		850018	850020	850019	850021	849981	849997	849992	849982	Šif. / Dostupnost

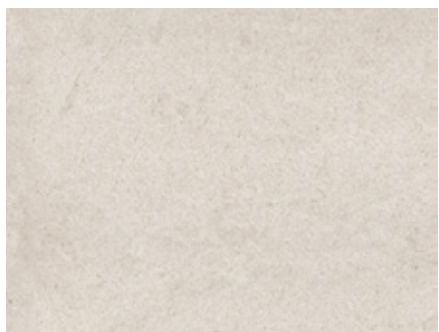

White

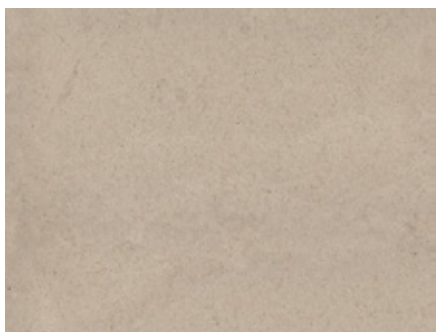

Ivory

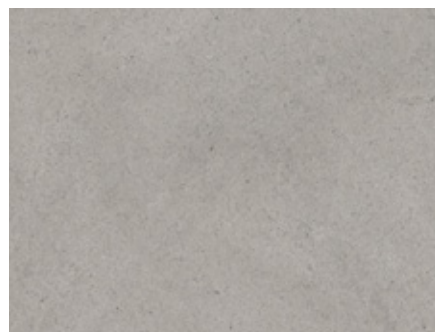

Grey

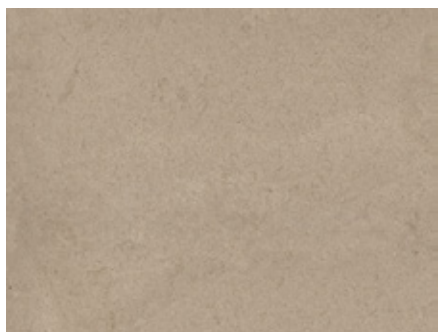

Taupe



Brown



CASA DOLCE CASA Sensi | Taupe | 60x120 | Sand

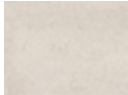

CASA DOLCE CASA Sensi | White | 60x120 | Lithos

120x120				120x240				Format (cm)
6				6				Debljina (mm)
Dust	Lithos	Sand	Fossil	Dust	Lithos	Sand	Fossil	Završna obrada
R9	R10 B	R9	R9	R9	R10 B	R9	R9	Protukliznost
	96,11	96,11	96,11	96,11	118,69	118,69	118,69	118,69
724,14	724,14	724,14	724,14	894,23	894,23	894,23	894,23	MPC (€/m ²)
849908	849928	849923	849909	849933	849953	849943	849934	MPC (Kn/m ²)
	96,11	96,11	96,11	96,11	118,69	118,69	118,69	118,69
724,14	724,14	724,14	724,14	894,23	894,23	894,23	894,23	MPC (€/m ²)
849910	849929	849924	849911	849935	849954	849944	849936	MPC (Kn/m ²)
	96,11	96,11	96,11	96,11	118,69	118,69	118,69	118,69
724,14	724,14	724,14	724,14	894,23	894,23	894,23	894,23	MPC (€/m ²)
849912	849930	849925	849913	849937	849955	849945	849938	MPC (Kn/m ²)
	96,11	96,11	96,11	96,11	118,69	118,69	118,69	118,69
724,14	724,14	724,14	724,14	894,23	894,23	894,23	894,23	MPC (€/m ²)
849914	849931	849926	849915	849939	849956	849946	849940	MPC (Kn/m ²)
	96,11	96,11	96,11	96,11	118,69	118,69	118,69	118,69
724,14	724,14	724,14	724,14	894,23	894,23	894,23	894,23	MPC (€/m ²)
849916	849932	849927	849917	849941	849957	849947	849942	MPC (Kn/m ²)
								Šif. / Dostupnost

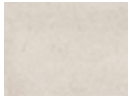
120x280			Format (cm)
6			Debljina (mm)
Dust	Lithos	Fossil	Završna obrada
R9	R10 B	R9	Protukliznost
	125,13	125,13	125,13
942,82	942,82	942,82	MPC (€/m ²)
849958	849968	849959	MPC (Kn/m ²)
	125,13	125,13	125,13
942,82	942,82	942,82	MPC (€/m ²)
849960	849969	849961	MPC (Kn/m ²)
	125,13	125,13	125,13
942,82	942,82	942,82	MPC (€/m ²)
849962	849970	849963	MPC (Kn/m ²)
	125,13	125,13	125,13
942,82	942,82	942,82	MPC (€/m ²)
849964	849971	849965	MPC (Kn/m ²)
	125,13	125,13	125,13
942,82	942,82	942,82	MPC (€/m ²)
849966	849972	849967	MPC (Kn/m ²)
			Šif. / Dostupnost



CERAMICHEITALIANE

ETHIK



Pod CERAMICHEITALIANE Ethik | White | 60x60 | Naturale
Zid CERAMICHEITALIANE Ethik | White/30x90 | Naturale; Grey | 30x90 | Naturale
Dekor Soft Mix Up | 30x90 | Naturale; Linear Mix Up | 30x90 | Naturale

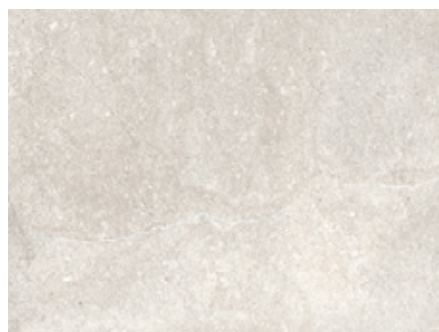

White



Beige

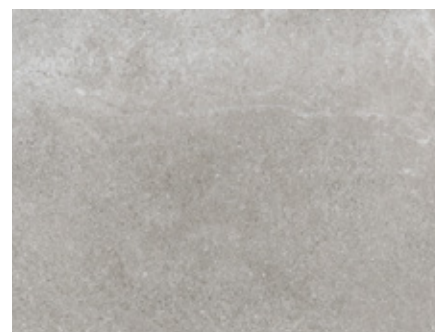

Grey

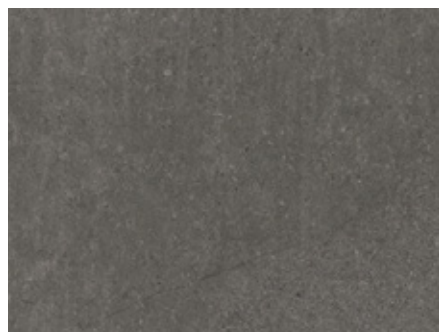

Dark











Soft Mix Up

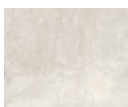

Linear Mix Up

Kolekcija Ethik nudi četiri boje kakve možemo pronaći u prirodi. Upotpunjena je dvama dekorima: ravnim te zakrivljenim linijama, koje podižu svaku kombinaciju pločica i zauvijek brišu monotonost u prostoru.

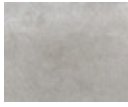
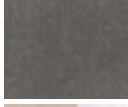
CERAMICHE ITALIANE ETHIK

		 30x60 9,5		 60x60 9,5		 30x90 9,5		 60x120 9,5		Format (cm)
		Naturale	Grip	Naturale	Grip	Naturale	Naturale			Debljina (mm)
		R9	R11	R9	R11	R9	R9			Završna obrada
										Protukliznost
	White			29,13		31,46				MPC (€/m ²)
				219,45		237,00				MPC (Kn/m ²)
				966157/L		966159/L				Šif. / Dostupnost
	Beige	29,13	29,13	29,13	29,13	31,46	36,12			MPC (€/m ²)
		219,45	219,45	219,45	219,45	237,00	272,12			MPC (Kn/m ²)
		611806/L	830408/L	597923/L	830406/L	966160/L	597432/L			Šif. / Dostupnost
	Grey	29,13	29,13	29,13	29,13	31,46	36,12			MPC (€/m ²)
		219,45	219,45	219,45	219,45	237,00	272,12			MPC (Kn/m ²)
		611805/L	830407/L	611804/L	830405/L	966162/L	611803/L			Šif. / Dostupnost
	Dark			29,13		31,46				MPC (€/m ²)
				219,45		237,00				MPC (Kn/m ²)
				966158/L		966161/L				Šif. / Dostupnost
	Soft Mix Up					31,46				MPC (€/m ²)
						237,00				MPC (Kn/m ²)
						966164/L				Šif. / Dostupnost
	Linear Mix Up					31,46				MPC (€/m ²)
						237,00				MPC (Kn/m ²)
						966163/L				Šif. / Dostupnost

CERAMICHE ITALIANE **PIETRA IONICA**





CERAMICHEITALIANE Pietra Ionica | Sabbia | Multiformat | Naturale



Sabbia

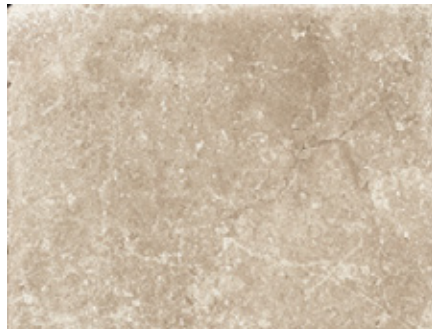





Beige

Pietra Ionica divna je kolekcija koja vjerno imitira površinu kamena u dvije nježne, neutralne boje.

Bilo da se radi o unutarnjoj ili vanjskoj pločici, Pietra Ionica donijet će vam osjećaj Mediterana.

CERAMICHE ITALIANE PIETRA IONICA

				
		Multiformat	40x60	Format (cm)
		9,5	9,5	Debljina (mm)
		Naturale	Grip	Završna obrada
		R10	R11	Protukliznost
	Sabbia	30,29	23,83	MPC (€/m ²)
		228,23	179,55	MPC (Kn/m ²)
		966174/Ⓞ	966176/Ⓞ	Šif. / Dostupnost
	Beige	30,29	23,83	MPC (€/m ²)
		228,23	179,55	MPC (Kn/m ²)
		966173/Ⓞ	966175/Ⓞ	Šif. / Dostupnost

CERIM

ROCK SALT



CERIM Rock Salt | Danish Smoke | 120x120 | Naturale

Prilikom narudžbe ploča velikih formata (120x240), naplaćuje se paleta. Po povratu palete, vrši se povrat novca.



White Gold

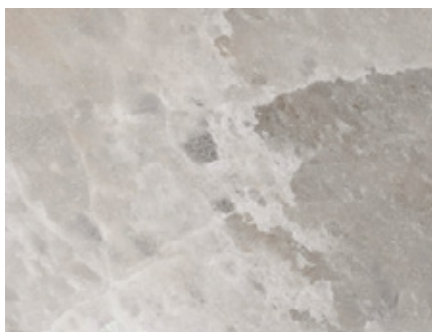

Celtic Grey



Danish Smoke



Maui Green

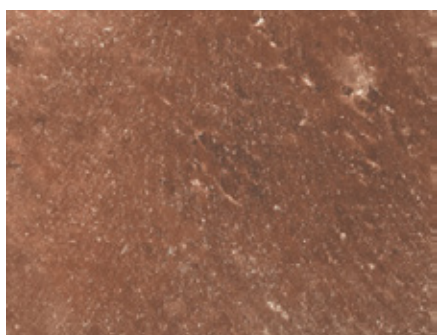

Hawaiian Red

Nadahnutu estetikom velikih blokova kamene soli izvađene iz podzemnih rudnika, a koja se također koristi za izgradnju zidova i kristala soli, kolekcija Rock Salt Cerima čini prostorije vrlo suvremenima.

Kolekcija nudi 5 različitih varijacija obogaćenih dubokih venama. Nijanse bijele, sive i boje kadulje, popraćene su toplijim tonovima, poput golublje sive i crvene.



CERIM Rock Salt | Hawaiian Red | 60x60, 60x120 | Naturale







CERIM ROCK SALT

		30x60			60x60		60x120		Format (cm)
		9			9		9		Debljina (mm)
		Naturale	Lucido	Bocciard.	Naturale	Lucido	Naturale	Lucido	Završna obrada
		R10 B		R11 B	R10 B		R10 B		Protukliznost
	White Gold	42,89	57,08	42,89	46,44	60,64	62,57	76,76	MPC (€/m ²)
		323,13	430,08	323,13	349,92	456,87	471,41	578,36	MPC (Kn/m ²)
		848446	848441	848436	848488	848481	824229	848474	Šif. / Dostupnost
	Celtic Grey	42,89	57,08	42,89	46,44	60,64	62,57	76,76	MPC (€/m ²)
		323,13	430,08	323,13	349,92	456,87	471,41	578,36	MPC (Kn/m ²)
		848447	848442	848437	848490	848482	846891	848471	Šif. / Dostupnost
	Danish Smoke	42,89	57,08	42,89	46,44	60,64	62,57	76,76	MPC (€/m ²)
		323,13	430,08	323,13	349,92	456,87	471,41	578,36	MPC (Kn/m ²)
		848448	848443	848438	848486	848483	848477	848473	Šif. / Dostupnost
	Maui Green	42,89	57,08	42,89	46,44	60,64	62,57	76,76	MPC (€/m ²)
		323,13	430,08	323,13	349,92	456,87	471,41	578,36	MPC (Kn/m ²)
		848449	848444	848439	848489	848485	824230	848475	Šif. / Dostupnost
	Hawaiian Red	42,89	57,08	42,89	46,44	60,64	62,57	76,76	MPC (€/m ²)
		323,13	430,08	323,13	349,92	456,87	471,41	578,36	MPC (Kn/m ²)
		848450	848445	848440	848487	848484	848476	848472	Šif. / Dostupnost





CERIM Rock Salt | Celtic Grey | 120x120 | Naturale

60x120		120x120		120x240		60x60	60x120	Format (cm)	
6		6		6		20	20	Debljina (mm)	
Naturale	Lucido	Naturale	Lucido	Naturale	Lucido	Bocciard.	Bocciard.	Završna obrada	
R10 B		R10 B		R10 B		R11 B	R11 B	Protukliznost	
	69,95	90,29	96,11	115,46	118,69	134,81	62,57	83,21	MPC (€/m ²)
527,03	680,30	724,14	869,93	894,23	1.015,70	471,41	626,95	MPC (Kn/m ²)	
848406	848402	848378	848373	848387	848382	848491	848479	Šif. / Dostupnost	
	69,95	90,29	96,11	115,46	118,69	134,81	62,57	83,21	MPC (€/m ²)
527,03	680,30	724,14	869,93	894,23	1.015,70	471,41	626,95	MPC (Kn/m ²)	
848407	848403	848379	848374	848388	848383	848492	848478	Šif. / Dostupnost	
	69,95	90,29	96,11	115,46	118,69	134,81	62,57	83,21	MPC (€/m ²)
527,03	680,30	724,14	869,93	894,23	1.015,70	471,41	626,95	MPC (Kn/m ²)	
848408	847694	847606	848375	848389	848384	848493	848480	Šif. / Dostupnost	
	69,95	90,29	96,11	115,46	118,69	134,81			MPC (€/m ²)
527,03	680,30	724,14	869,93	894,23	1.015,70			MPC (Kn/m ²)	
848409	848404	848380	848376	848390	848385			Šif. / Dostupnost	
									MPC (€/m ²)
									MPC (Kn/m ²)
									Šif. / Dostupnost

COTTO D'ESTE **BLEND STONE**





Clear



Light



Mid

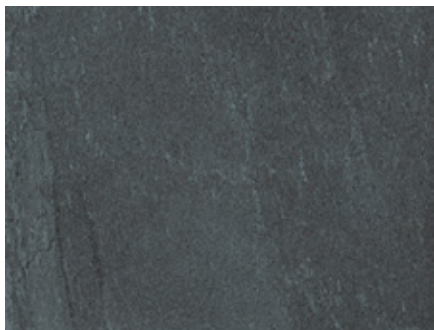

Deep





COTTO D'ESTE Blend Stone | Mid | 90x90 | Bocciardata



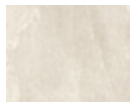

Blend Stone kolekcija nudi jedinstven dizajn pločice koja imitira kamen. Na prvi pogled jednostavna, no kada se detaljnije pogleda uočavaju se fragmenti ispod površine koji se kombiniraju s izgledom mineralnih tekstura u prirodi.

Kolekcija je inspirirana teksturama kamena te njegovim bogatim bojama, pa se tako u Blend Stoneu pronalaze četiri boje koje će se savršeno stopiti sa svakim interijerom.

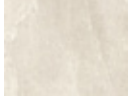

COTTO D'ESTE BLEND STONE

		30x60			60x60			Format (cm)
		14			14			Debljina (mm)
		Naturale	Lappata	Sabiatta	Naturale	Lappata	Sabiatta	Završna obrada
		R10 B		R11 C	R10 B		R11 C	Protukliznost
	Clear	61,23	66,13	62,46	61,23	66,13	66,13	MPC (€/m ²)
		461,35	498,25	470,58	461,35	498,25	498,25	MPC (Kn/m ²)
		985834	985846	985835	985894	985902	985895	Šif. / Dostupnost
	Light	61,23	66,13	62,46	61,23	66,13	62,46	MPC (€/m ²)
		461,35	498,25	470,58	461,35	498,25	470,58	MPC (Kn/m ²)
		985838	985848	985839	985898	985904	985899	Šif. / Dostupnost
	Mid	61,23	66,13	62,46	61,23	66,13	62,46	MPC (€/m ²)
		461,35	498,25	470,58	461,35	498,25	470,58	MPC (Kn/m ²)
		985840	985849	985841	985900	985905	985901	Šif. / Dostupnost
	Deep	61,23	66,13	62,46	61,23	66,13	62,46	MPC (€/m ²)
		461,35	498,25	470,58	461,35	498,25	470,58	MPC (Kn/m ²)
		985836	985847	985837	985896	985903	985897	Šif. / Dostupnost





90x90			60x120			Format (cm)	
14			14			Debljina (mm)	
Naturale	Lappata	Sabiatta	Naturale	Lappata	Sabiatta	Završna obrada	
R10 B		R11 C	R10 B		R11 C	Protukliznost	
	66,13	69,80	67,35	66,13	69,80	67,35	MPC (€/m ²)
498,25	525,94	507,48	498,25	525,94	507,48	507,48	MPC (Kn/m ²)
985914	985926	985915	985879	985890	985880		Šif. / Dostupnost
	66,13	69,80	67,35	66,13	69,80	67,35	MPC (€/m ²)
498,25	525,94	507,48	498,25	525,94	507,48	507,48	MPC (Kn/m ²)
985920	985928	985921	985885	985892	985886		Šif. / Dostupnost
	66,13	69,80	67,35	66,13	69,80	67,35	MPC (€/m ²)
498,25	525,94	507,48	498,25	525,94	507,48	507,48	MPC (Kn/m ²)
985923	985929	985924	985888	985893	985889		Šif. / Dostupnost
	66,13	69,80	67,35	66,13	69,80	67,35	MPC (€/m ²)
498,25	525,94	507,48	498,25	525,94	507,48	507,48	MPC (Kn/m ²)
985917	985927	985918	985882	985891	985883		Šif. / Dostupnost



COTTO D'ESTE Blend Stone | Clear | 120x120 | Lappata

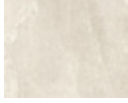

COTTO D'ESTE Blend Stone | Mid | 90x90 | Bocciardata

120x120			90x180		60x120	90x90	Format (cm)	
14			14		20	20	Debljina (mm)	
Naturale	Lappata	Sabiatta	Naturale	Lappata	Bocciardata	Bocciardata	Završna obrada	
R10 B		R11 C	R10 B		R12 C	R12 C	Protukliznost	
	72,25	74,70	72,25	75,93	79,60	85,72	85,72	MPC (€/m ²)
	544,39	562,84	544,39	572,06	599,75	645,89	645,89	MPC (Kn/m ²)
	985930	985938	985931	985906	985910	985878	985916	Šif. / Dostupnost
	72,25	74,70	72,25	75,93	79,60	85,72	85,72	MPC (€/m ²)
	544,39	562,84	544,39	572,06	599,75	645,89	645,89	MPC (Kn/m ²)
	985934	985940	985935	985908	985912	985884	985922	Šif. / Dostupnost
	72,25	74,70	72,25	75,93	79,60	85,72	85,72	MPC (€/m ²)
	544,39	562,84	544,39	572,06	599,75	645,89	645,89	MPC (Kn/m ²)
	985936	985941	985937	985909	985913	985887	985925	Šif. / Dostupnost
	72,25	74,70	72,25	75,93	79,60	85,72	85,72	MPC (€/m ²)
	544,39	562,84	544,39	572,06	599,75	645,89	645,89	MPC (Kn/m ²)
	985932	985939	985933	985907	985911	985881	985919	Šif. / Dostupnost

COTTO D'ESTE LIMESTONE



COTTO D'ESTE Limestone | Oyster | 60x120 | Honed

Prilikom narudžbe ploča velikih formata (120x250, 100x300), naplaćuje se paleta. Po povratu palete, vrši se povrat novca.



Clay



Amber



Oyster



Slate

Limestone donosi nevjerovatno mnogo detalja na površini jedne pločice. Stvara se osjećaj dubine te se unosi moderan izgled.

Pločice iz ove kolekcije ostavljaju vrlo nježan dojam. Za lakši odabir formata, Limestone nudi širinu izbora.







COTTO D'ESTE Limestone | Oyster | 60x120 | Fiammata



COTTO D'ESTE Limestone | Oyster | 60x120 | Honed

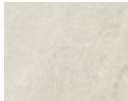

COTTO D'ESTE LIMESTONE

		30x60			60x60			60x120			Format (cm)
		14			14			14			Debljina (mm)
		Naturale	Honed	Blazed	Naturale	Honed	Blazed	Naturale	Honed	Blazed	Završna obrada
		R10 B		R11 C	R10 B		R11 C	R10 B		R11 C	Protukliznost
	Clay	58,78	62,46	58,78	58,78	62,46	58,78	52,12	69,80	52,12	MPC (€/m ²)
		442,89	470,58	442,89	442,89	470,58	442,89	392,70	525,94	392,70	MPC (Kn/m ²)
		455500	455499	455498	455538	455537	455536	455528/Ⓛ	455527	455526/Ⓛ	Šif. / Dostupnost
	Amber	58,78	62,46	58,78	58,78	62,46	58,78	65,15	69,80	65,15	MPC (€/m ²)
		442,89	470,58	442,89	442,89	470,58	442,89	490,88	525,94	490,88	MPC (Kn/m ²)
		455497	455496	455495	455535	455534	455195	455525	455524	455523	Šif. / Dostupnost
	Oyster	58,78	62,46	58,78	58,78	62,46	58,78	65,15	69,80	65,15	MPC (€/m ²)
		442,89	470,58	442,89	442,89	470,58	442,89	490,88	525,94	490,88	MPC (Kn/m ²)
		455503	455502	455501	455541	455540	455539	455531	455530	455529	Šif. / Dostupnost
	Slate	58,78	62,46	58,78	58,78	62,46	58,78	65,15	69,80	65,15	MPC (€/m ²)
		442,89	470,58	442,89	442,89	470,58	442,89	490,88	525,94	490,88	MPC (Kn/m ²)
		455506	455505	455504	455544	455543	455542	455204	455533	455532	Šif. / Dostupnost





COTTO D'ESTE Limestone | Clay | 60x120 | Honed

Pod COTTO D'ESTE Limestone | Slate | 60x60 | Naturale
Zid COTTO D'ESTE Limestone | Slate | 30x60 | Naturale

90x90		50x100	100x100	100x250	100x300	60x120	90x90	Format (cm)
14		5,5	5,5	5,5	5,5	20	20	Debljina (mm)
Naturale	Honed	Naturale	Naturale	Naturale	Naturale	Fiammata	Fiammata	Završna obrada
R10 B		R10 B	R10 B	R10 B	R10 B	R11 C	R11 C	Protukliznost
65,15	69,80	83,27	83,27	85,72	90,62	85,72	85,72	MPC (€/m ²)
490,88	525,94	627,43	627,43	645,89	682,79	645,89	645,89	MPC (Kn/m ²)
480854	469301	495831	478563	497214	495365	497238	604356	Šif. / Dostupnost
65,15	69,80	83,27	83,27	85,72	90,62	85,72	85,72	MPC (€/m ²)
490,88	525,94	627,43	627,43	645,89	682,79	645,89	645,89	MPC (Kn/m ²)
495866	495865	495829	495830	497213	495828	497236	604355	Šif. / Dostupnost
65,15	69,80	83,27	83,27	85,72	90,62	85,72	85,72	MPC (€/m ²)
490,88	525,94	627,43	627,43	645,89	682,79	645,89	645,89	MPC (Kn/m ²)
495871	495870	495832	455135	497215	495833	497240	604357	Šif. / Dostupnost
65,15	69,80	83,27	83,27	85,72	90,62	85,72	85,72	MPC (€/m ²)
490,88	525,94	627,43	627,43	645,89	682,79	645,89	645,89	MPC (Kn/m ²)
495874	495873	495834	495835	497216	495836	497242	604358	Šif. / Dostupnost

COTTO D'ESTE

LITHOS



COTTO D'ESTE Lithos | Moon | 120x120 | Soft

Prilikom narudžbe ploča velikih formata (120x260), naplaćuje se paleta. Po povratu palete, vrši se povrat novca.



Moon



Stone

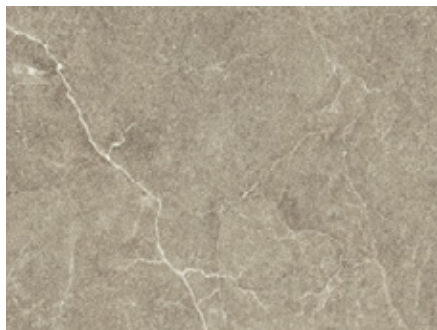

Desert

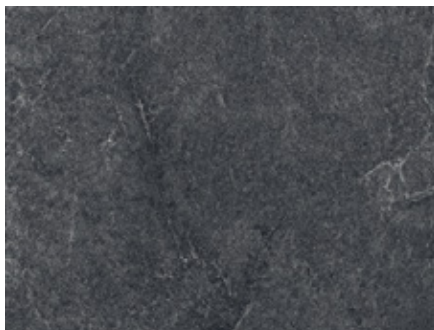

Carbon

Kolekcija Lithos rezultat je neprestanog divljenja prirodi i kamenu koji se pronalazi u bezbroj boja.

Nove boje i obrade stvaraju zanimljive grafičke efekte na površini te na taj način stvaraju jedinstvenu osobnost prostorijama u kojima se ove pločice nađu.

Lithos je dio PROTECT® linije proizvoda: antimikrobne podne i zidne pločice, dizajnirane za zdrave, sigurne i zaštićene životne prostore





COTTO D'ESTE Lithos | Carbon | 90x90 | Lappata



COTTO D'ESTE
LITHOS

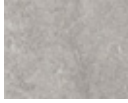



		30x60				60x60				Format (cm)
		14				14				Debljina (mm)
		Naturale	Lappata	Sabbiata	Grip	Naturale	Lappata	Sabbiata	Grip	Završna obrada
		R10 B		R11 B	R12 C	R10 B		R11 B	R12 C	Protukliznost
	Moon	58,78	62,46	58,78	58,78	58,78	62,46	58,78	58,78	MPC (€/m ²)
		442,89	470,58	442,89	442,89	442,89	470,58	442,89	442,89	MPC (Kn/m ²)
		823609	823613	823610	823611	823667	823670	823668	823669	Šif. / Dostupnost
	Stone	58,78	62,46	58,78	58,78	58,78	62,46	58,78	58,78	MPC (€/m ²)
		442,89	470,58	442,89	442,89	442,89	470,58	442,89	442,89	MPC (Kn/m ²)
		823614	823618	823615	823616	823671	823674	823672	823673	Šif. / Dostupnost
	Desert	58,78	62,46	58,78	58,78	58,78	62,46	58,78	58,78	MPC (€/m ²)
		442,89	470,58	442,89	442,89	442,89	470,58	442,89	442,89	MPC (Kn/m ²)
		823604	823608	823605	823606	823663	823666	823664	823665	Šif. / Dostupnost
	Carbon	58,78	62,46	58,78	58,78	58,78	62,46	58,78	58,78	MPC (€/m ²)
		442,89	470,58	442,89	442,89	442,89	470,58	442,89	442,89	MPC (Kn/m ²)
		823599	823603	823600	823601	823659	823662	823660	823661	Šif. / Dostupnost

60x120				90x90			Format (cm)
14				14			Debljina (mm)
Naturale	Lappata	Sabbiata	Grip	Naturale	Lappata	Sabbiata	Završna obrada
R10 B		R11 B	R12 C	R10 B		R11 C	Protukliznost
	65,15	69,80	65,15	65,15	69,80	65,15	MPC (€/m ²)
	490,88	525,94	490,88	490,88	525,94	490,88	MPC (Kn/m ²)
	823655	823656	866759	866763	823681	823683	Šif. / Dostupnost
	65,15	69,80	65,15	65,15	69,80	65,15	MPC (€/m ²)
	490,88	525,94	490,88	490,88	525,94	490,88	MPC (Kn/m ²)
	823657	823658	866760	866764	823684	823686	Šif. / Dostupnost
	65,15	69,80	65,15	65,15	69,80	65,15	MPC (€/m ²)
	490,88	525,94	490,88	490,88	525,94	490,88	MPC (Kn/m ²)
	823653	823654	866758	866762	823678	823680	Šif. / Dostupnost
	65,15	69,80	65,15	65,15	69,80	65,15	MPC (€/m ²)
	490,88	525,94	490,88	490,88	525,94	490,88	MPC (Kn/m ²)
	823651	823652	866757	866761	823675	823677	Šif. / Dostupnost

COTTO D'ESTE Lithos | Moon | 120x120 | Soft





	60x120		120x120		120x260		90x90	Format (cm)
	6,5		6,5		6,5		20	Debljina (mm)
	Naturale	Soft	Naturale	Soft	Naturale	Soft	Bocciardata	Završna obrada
	R10		R10		R10		R12 C	Protukliznost
	77,15	82,05	77,15	82,05	90,62	95,52	86,92	MPC (€/m ²)
	581,29	618,20	581,29	618,20	682,79	719,70	654,89	MPC (Kn/m ²)
	866707	866711	824637	853691	824659	853694	823682	Šif. / Dostupnost
	77,15	82,05	77,15	82,05	90,62	95,52	86,92	MPC (€/m ²)
	581,29	618,20	581,29	618,20	682,79	719,70	654,89	MPC (Kn/m ²)
	866708	866712	824657	853692	824658	853695	823685	Šif. / Dostupnost
	77,15	82,05	77,15	82,05	90,62	95,52	86,92	MPC (€/m ²)
	581,29	618,20	581,29	618,20	682,79	719,70	654,89	MPC (Kn/m ²)
	866706	866710	824636	853690	824661	853693	823679	Šif. / Dostupnost
	77,15	82,05	77,15	82,05	90,62	95,52	86,92	MPC (€/m ²)
	581,29	618,20	581,29	618,20	682,79	719,70	654,89	MPC (Kn/m ²)
	866705	866709	824660	853689	824656	848660	823676	Šif. / Dostupnost

COTTO D'ESTE





SECRET STONE

Misterij drevnog kamena koji je zakopan u pustinjama potaknuo je Cotto d'Este na još jednu divnu kolekciju naziva Secret Stone. Istraživanjem te proučavanjem jeruzalemskog kamena, nastala je kolekcija koja hvata te poboljšava njegovu ljepotu. Lijepo i rijetke varijante boja te slojevi kamena uspješno su reproducirani i preneseni na površinu pločice.



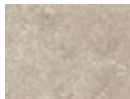

**COTTO D'ESTE
SECRET STONE**

		 30x60			 60x60			Format (cm)
		14			14			Debljina (mm)
		Naturale	Honed	Grip	Naturale	Honed	Grip	Završna obrada
		R10 B		R11 C	R10 B		R11 C	Protukliznost
	Mystery White	58,78	62,46	58,78	47,03	62,46	47,03	MPC (€/m ²)
		442,89	470,58	442,89	354,31	470,58	354,31	MPC (Kn/m ²)
		495889	495887	495885	495888/Ⓛ	495886	495884/Ⓛ	Šif. / Dostupnost
	Precious Beige	58,78	62,46	58,78	58,78	62,46	58,78	MPC (€/m ²)
		442,89	470,58	442,89	442,89	470,58	442,89	MPC (Kn/m ²)
		495908	495906	495904	495907	495905	495903	Šif. / Dostupnost
	Shadow Grey	58,78	62,46	58,78	58,78	62,46	58,78	MPC (€/m ²)
		442,89	470,58	442,89	442,89	470,58	442,89	MPC (Kn/m ²)
		495945	495950	495947	495944	495949	495946	Šif. / Dostupnost







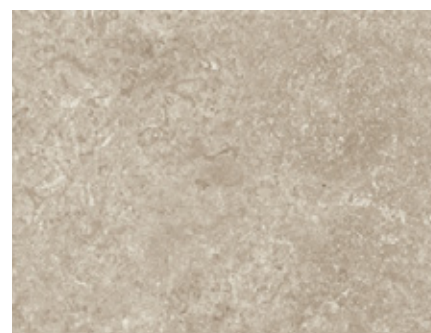

Mystery White



Precious Beige

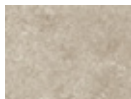

Shadow Grey

		 60x120		 90x90		 60x120		 90x90		Format (cm)
		14		14		20		20		Debljina (mm)
		Naturale	Honed	Naturale	Honed	Grip	Grip			Završna obrada
		R10 B		R10 B		R11 C	R11 C			Protukliznost
	Mystery White	65,15	69,80	65,15	69,80	85,72	85,72			MPC (€/m ²)
		490,88	525,94	490,88	525,94	645,89	645,89			MPC (Kn/m ²)
		495893	495890	495892	495891	551219	604374			Šif. / Dostupnost
	Precious Beige	65,15	69,80	65,15	69,80	85,72	85,72			MPC (€/m ²)
		490,88	525,94	490,88	525,94	645,89	645,89			MPC (Kn/m ²)
		495911	495909	495912	495910	551228	604375			Šif. / Dostupnost
	Shadow Grey	65,15	69,80	65,15	69,80	85,72	85,72			MPC (€/m ²)
		490,88	525,94	490,88	525,94	645,89	645,89			MPC (Kn/m ²)
		495952	495948	495943	495951	551246	604377			Šif. / Dostupnost

COTTO D'ESTE PIETRA D'ISEO

Pietra d'Iseo kolekcija inspirirana je tipičnim langobardskim kamenom, Ceppo di Grè, koji se koristio za gradnju palača, vila i spomenika koji karakteriziraju povijesni izgled grada Milana.

Svojim nepravilnim dizajnom i tonom u sivoj boji, dodaje karakter i osjećaj profinjenosti svakom okruženju.



COTTO D'ESTE Pietra d'Iseo | Ceppo | 120x260 | Naturale







Prilikom narudžbe ploča velikih formata (120x260), naplaćuje se paleta. Po povratu palete, vrši se povrat novca.



COTTO D'ESTE Pietra d'Iseo | Ceppo | 90x90 | Bocciardata



Ceppo

COTTO D'ESTE PIETRA D'ISEO							
		60x60	60x120	120x120	120x260	90x90	
		6,5	6,5	6,5	6,5	20	Format (cm)
		Naturale	Naturale	Naturale	Naturale	Bocciardata	Debljina (mm)
		R10 B	R10 B	R10 B	R10 B	R12 C	Završna obrada
		78,38	78,38	78,38	83,27	88,17	Protukliznost
	Ceppo	590,53	590,53	590,53	627,43	664,34	MPC (€/m ²)
		604334	604160	604335	604336	824655	MPC (Kn/m ²)
							Šif. / Dostupnost

FLOOR GRES **AIRTECH**





Miami White

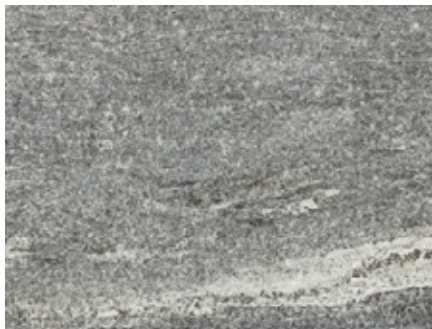

Stockholm Greige

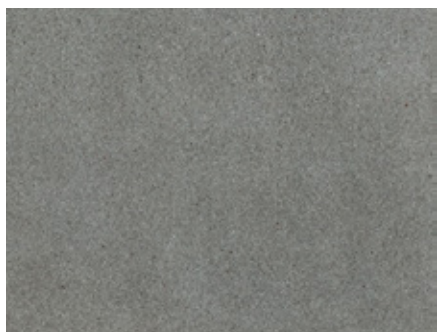

New York Light Grey



Basel Grey

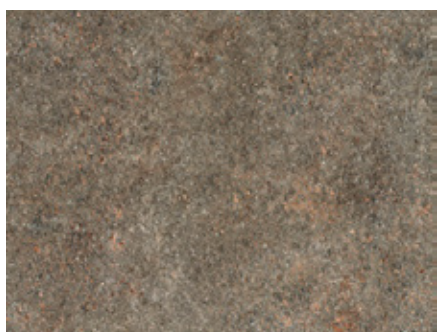

Berlin Red

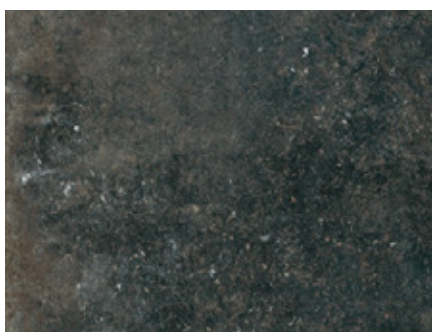

London Black

Airtech kolekcija interpretira šest vrsta prirodnog kamena koji ostavljaju dojam diskretnog luksuza u prostoriji. Njihova estetika čini ih jednostavnima za prilagođavanje različitim stilovima namještaja i uređenjima interijera.

Pločice dolaze u različitim nijansama sive boje, a prigodne su i za vanjsko opločenje.

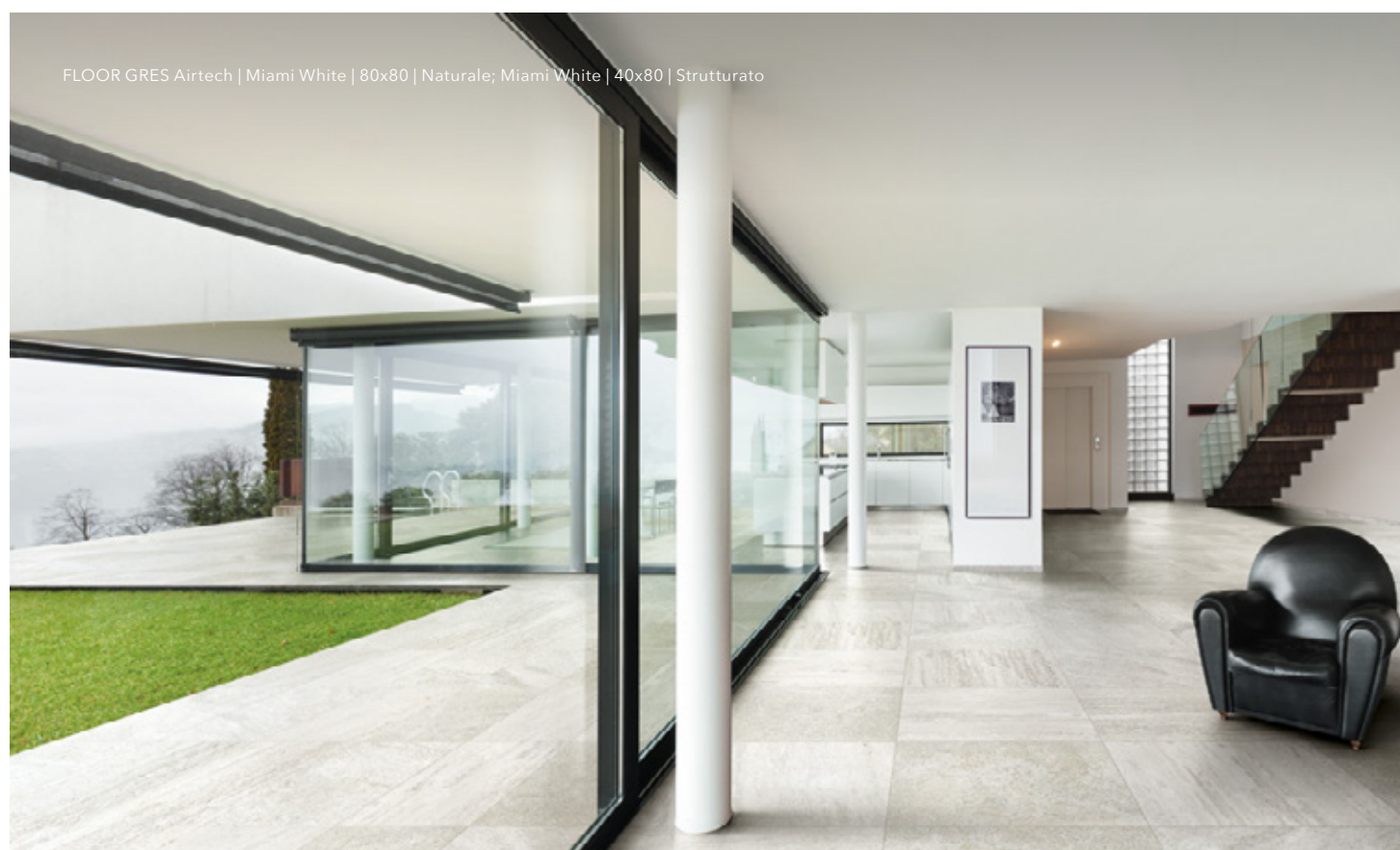

FLOOR GRES Airtech | Miami White | 80x80 | Naturale; Miami White | 40x80 | Strutturato











FLOOR GRES Airtech | Miami White | 20,2x30,4, 20,2x20,2 | Strutturato

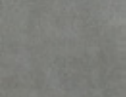

FLOOR GRES AIRTECH

		30x60		60x60		60x120		40x80		Format (cm)
		9		9		9		9		Debljina (mm)
		Naturale	Strutturato	Naturale	Strutturato	Naturale	Glossy	Naturale	Strutturato	Završna obrada
		R9 B	R11 C	R9 B	R11 C	R9 B		R9 B	R11 C	Protukliznost
	Miami White	46,44	46,44	53,86	53,86	82,55	96,74	53,86	53,86	MPC (€/m ²)
		349,92	349,92	405,78	405,78	621,95	728,91	405,78	405,78	MPC (Kn/m ²)
		605590	605596	605579	605584	605567	605573	605614	605620	Šif. / Dostupnost
	Stockholm Greige	46,44	46,44	53,86	53,86	82,55	96,74	53,86	53,86	MPC (€/m ²)
		349,92	349,92	405,78	405,78	621,95	728,91	405,78	405,78	MPC (Kn/m ²)
		605592	605598	605580	605586	605569	605575	605616	605622	Šif. / Dostupnost
	New York Light Grey	46,44	46,44	53,86	53,86	82,55	96,74	53,86	53,86	MPC (€/m ²)
		349,92	349,92	405,78	405,78	621,95	728,91	405,78	405,78	MPC (Kn/m ²)
		605587	605593	605576	605581	605564	605570	605627	605617	Šif. / Dostupnost
	Basel Grey	46,44	46,44	53,86	53,86	82,55	96,74	53,86	53,86	MPC (€/m ²)
		349,92	349,92	405,78	405,78	621,95	728,91	405,78	405,78	MPC (Kn/m ²)
		605591	605597	605595	605585	605568	605574	605615	605621	Šif. / Dostupnost
	Berlin Red	46,44	46,44	53,86	53,86	82,55	96,74	53,86	53,86	MPC (€/m ²)
		349,92	349,92	405,78	405,78	621,95	728,91	405,78	405,78	MPC (Kn/m ²)
		605588	605594	605577	605582	605565	605571	605612	605618	Šif. / Dostupnost
	London Black	46,44	46,44	53,86	53,86	82,55	96,74	53,86	53,86	MPC (€/m ²)
		349,92	349,92	405,78	405,78	621,95	728,91	405,78	405,78	MPC (Kn/m ²)
		605589	605611	605578	605583	605566	605572	605613	605619	Šif. / Dostupnost

				
	80x80	60x60	60x120	Format (cm)
	9	20	20	Debljina (mm)
	Naturale	Strutturato	Strutturato	Završna obrada
	R9 B	R11 C	R11 C	Protukliznost
	75,13	69,35	87,07	MPC (€/m ²)
	566,09	522,50	656,01	MPC (Kn/m ²)
	605608	605623	605626	Šif. / Dostupnost
	75,13	69,35	87,07	MPC (€/m ²)
	566,09	522,50	656,01	MPC (Kn/m ²)
	605610	605625	605628	Šif. / Dostupnost
	75,13			MPC (€/m ²)
	566,09			MPC (Kn/m ²)
	605605			Šif. / Dostupnost
	75,13	69,35	87,07	MPC (€/m ²)
	566,09	522,50	656,01	MPC (Kn/m ²)
	605609	605624	605631	Šif. / Dostupnost
	75,13			MPC (€/m ²)
	566,09			MPC (Kn/m ²)
	605606			Šif. / Dostupnost
				MPC (€/m ²)
				MPC (Kn/m ²)
				Šif. / Dostupnost



LEA ANTHOLOGY



Pod LEA Anthology | White | 60x60/Rough, White 60x60 | Worn
Zid LEA Anthology | White Mosaico Break | 29x31 | Worn



White



Desert

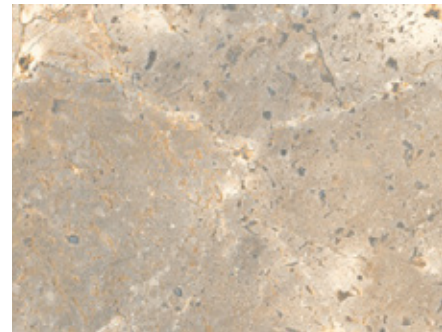

Earth



Gray

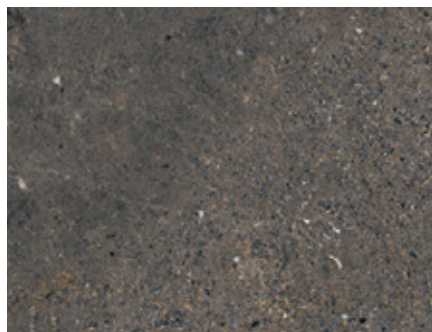









Dark

Kombinacijom kamena i mramora nastaje novi stil pločice koju u ovoj kolekciji možemo dobiti u pet boja. Svaka boja ima snažan karakter i vrlo poseban, bogat estetski dojam.

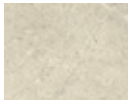
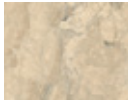
Posebnost pločicama daje sinergija vizualnih i taktilnih detalja koji kreiraju doživljaj prirodnog kamena.

LEA
ANTHOLOGY

	 30x60			 60x60			 60x120			 60x120	Format (cm)	
	9,5			9,5			9,5			20	Debljina (mm)	
	Natural	Worn	Rough	Natural	Worn	Rough	Natural	Worn	Rough	Rough	Završna obrada	
	R10 B	R9	R11 C	R10 B	R9	R11 C	R10 B	R9	R11 C	R11 C	Protukliznost	
	White	47,03	49,96	49,96	47,03	49,96	49,96	53,88	56,33	53,88	86,95	MPC (€/m ²)
		354,31	376,46	376,46	354,31	376,46	376,46	405,99	424,44	405,99	655,11	MPC (Kn/m ²)
		854006	854016	854011	854036	854046	854041	854021	854031	854026	854121	Šif. / Dostupnost
	Desert	47,03	49,96	49,96	47,03	49,96	49,96	53,88	56,33	53,88	86,95	MPC (€/m ²)
		354,31	376,46	376,46	354,31	376,46	376,46	405,99	424,44	405,99	655,11	MPC (Kn/m ²)
		854007	854017	854012	854037	854047	854042	854022	854032	854027	854122	Šif. / Dostupnost
	Earth	47,03	49,96	49,96	47,03	49,96	49,96	53,88	56,33	53,88	86,95	MPC (€/m ²)
		354,31	376,46	376,46	354,31	376,46	376,46	405,99	424,44	405,99	655,11	MPC (Kn/m ²)
		854008	854018	854013	854038	854048	854043	854023	854033	854028	854123	Šif. / Dostupnost
	Gray	47,03	49,96	49,96	47,03	49,96	49,96	53,88	56,33	53,88	86,95	MPC (€/m ²)
		354,31	376,46	376,46	354,31	376,46	376,46	405,99	424,44	405,99	655,11	MPC (Kn/m ²)
		854009	854019	854014	854039	854049	854044	854024	854034	854029	854124	Šif. / Dostupnost
	Dark	47,03	49,96	49,96	47,03	49,96	49,96	53,88	56,33	53,88	86,95	MPC (€/m ²)
		354,31	376,46	376,46	354,31	376,46	376,46	405,99	424,44	405,99	655,11	MPC (Kn/m ²)
		854010	854020	854015	854040	854050	854045	854025	854035	854030	854125	Šif. / Dostupnost



LEA NEXTONE



LEA Nextone | White | 60x120 | Naturale

Prilikom narudžbe ploča velikih formata (120x260),
naplaćuje se paleta. Po povratu palete, vrši se povrat novca.

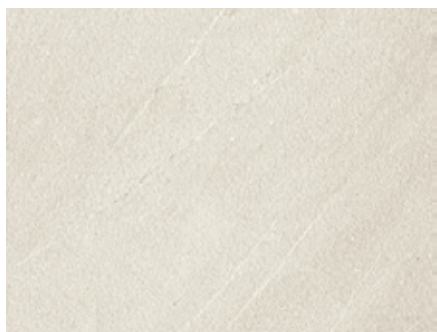

White



Gray

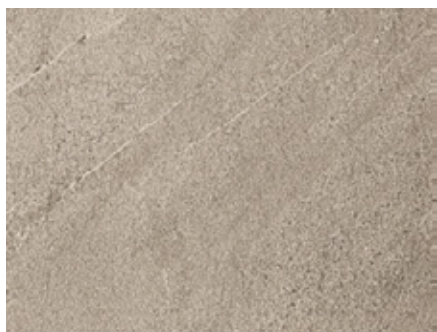

Taupe

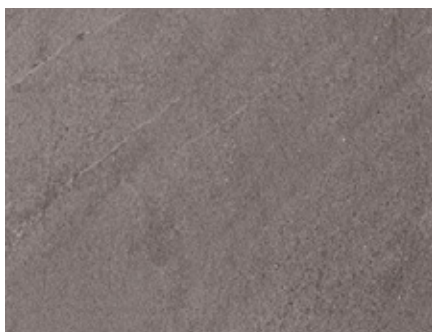

Dark

Kolekcija Nextone uzima sve najljepše iz četiri kamena koja nalazimo u prirodi te stvara dojam potpuno novog kamena.

Pločice iz ove kolekcije zaista se uklapaju u bilo koju vrstu interijera jer su boje nježne i neutralne te su obogaćene toplim tonovima. Kolekcija nudi širok raspon formata te čak tri prekrasna dekora.



Pod LEA Nextone | Taupe | 60x60 | Naturale
Mozaik Taupe Mosaico | 30x60 | Naturale



LEA NEXTONE

		30x60		60x60			60x120		Format (cm)
		9,5		9,5			9,5		Debljina (mm)
		Naturale	Lappato	Naturale	Lappato	Grip	Naturale	Lappato	Završna obrada
		R10 B		R10 B		R11 C	R10 B		Protukliznost
	White	46,54	50,21	37,23	40,17	37,23	43,12	45,07	MPC (€/m ²)
		350,63	378,30	280,50	302,64	280,50	324,79	339,55	MPC (Kn/m ²)
		550261	550229	550260/L	550228/L	550215/L	550259/L	550227/L	Šif. / Dostupnost
	Gray	46,54	50,21	46,54	50,21	46,54	53,88	56,33	MPC (€/m ²)
		350,63	378,30	350,63	378,30	350,63	405,99	424,44	MPC (Kn/m ²)
		550264	550232	550263	550231	550216	550262	550230	Šif. / Dostupnost
	Taupe	46,54	50,21	46,54	50,21	46,54	53,88	56,33	MPC (€/m ²)
		350,63	378,30	350,63	378,30	350,63	405,99	424,44	MPC (Kn/m ²)
		550267	550235	550266	550234	550217	550265	550233	Šif. / Dostupnost
	Dark	46,54	50,21	46,54	50,21	46,54	53,88	56,33	MPC (€/m ²)
		350,63	378,30	350,63	378,30	350,63	405,99	424,44	MPC (Kn/m ²)
		550270	550238	550269	550237	550218	550268	550236	Šif. / Dostupnost



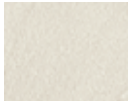
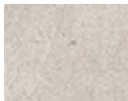

Pod LEA Nextone | White | 90x90 | Naturale
Zid LEA Nextone | White | 120x260 | Naturale

45x90		90x90		120x120	120x260	60x60	60x120	Format (cm)	
9,5		9,5		6	6	20	20	Debljina (mm)	
Naturale	Lappato	Naturale	Lappato	Naturale	Naturale	Grip	Grip	Završna obrada	
R10 B		R10 B		R10	R10	R11 C	R11 C	Protukliznost	
	53,88	56,33	53,88	56,33	82,05	88,17	80,96	86,95	MPC (€/m ²)
	405,99	424,44	405,99	424,44	618,20	664,34	608,98	655,11	MPC (Kn/m ²)
	603670	603666	603662	603659	853626	853630	550271	550272	Šif. / Dostupnost
	53,88	56,33	53,88	56,33	82,05	88,17	80,96	86,95	MPC (€/m ²)
	405,99	424,44	405,99	424,44	618,20	664,34	608,98	655,11	MPC (Kn/m ²)
	603668	603664	603660	603657	853624	853628	550273	550274	Šif. / Dostupnost
	53,88	56,33	53,88	56,33	82,05	88,17			MPC (€/m ²)
	405,99	424,44	405,99	424,44	618,20	664,34			MPC (Kn/m ²)
	603669	603665	603661	603658	853625	853629			Šif. / Dostupnost
	53,88	56,33	53,88	56,33	82,05	88,17			MPC (€/m ²)
	405,99	424,44	405,99	424,44	618,20	664,34			MPC (Kn/m ²)
	603667	603663	603416	603656	853623	853627			Šif. / Dostupnost



LEA

WATERFALL



LEA Waterfall | Ivory Flow | 90x90 | Naturale

Prilikom narudžbe ploča velikih formata (100x300),
naplaćuje se paleta. Po povratu palete, vrši se povrat novca.

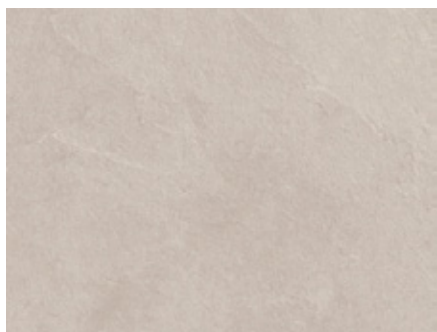

Ivory Flow



Silver Flow

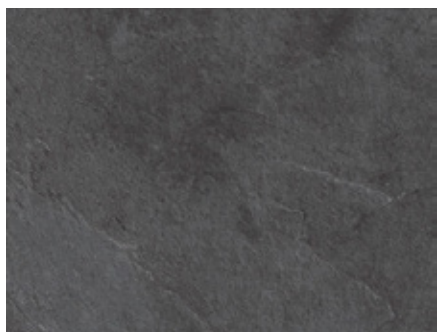

Gray Flow

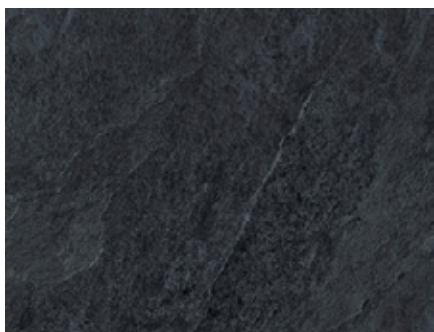

Dark Flow

Waterfall kolekcija nudi izbor sivih pločica, od najsvjetlijeg do najtamnijeg tona. Ova kolekcija podsjeća na oksidaciju kamena u prirodi te na materijale koji se zubom vremena neprestano mijenjaju.

Širok raspon dimenzija omogućava kombinacije postavljanja pločica čime se može dobiti poseban estetski doživljaj.



Pod LEA Waterfall | Dark Flow | 90x90 | Lappato
Zid LEA Waterfall | Dark Flow | 30x60 | Lappato
Mozaik 36 | Dark Flow | Lappato











LEA WATERFALL

	30x60		60x60			60x120		45x90		Format (cm)	
	9,5		9,5			9,5		9,5		Debljina (mm)	
	Naturale	Lappato	Naturale	Lappato	Grip	Naturale	Lappato	Naturale	Lappato	Završna obrada	
	Ivory Flow	46,54	50,21	46,54	50,21	46,54	53,88	56,33	53,88	56,33	MPC (€/m ²)
		350,63	378,30	350,63	378,30	350,63	405,99	424,44	405,99	424,44	MPC (Kn/m ²)
		497192	497131	497155	497135	497069	497160	497127	497162	497129	Šif. / Dostupnost
	Silver Flow	46,54	50,21	46,54	50,21	46,54	53,88	56,33	53,88	56,33	MPC (€/m ²)
		350,63	378,30	350,63	378,30	350,63	405,99	424,44	405,99	424,44	MPC (Kn/m ²)
		497193	497136	497159	497137	497070	497163	497132	497165	497134	Šif. / Dostupnost
	Gray Flow	46,54	50,21	46,54	50,21	46,54	53,88	56,33	53,88	56,33	MPC (€/m ²)
		350,63	378,30	350,63	378,30	350,63	405,99	424,44	405,99	424,44	MPC (Kn/m ²)
		497191	497126	497154	495363	497068	497156	497123	497158	497125	Šif. / Dostupnost
	Dark Flow	46,54	50,21	46,54	50,21	46,54	53,88	56,33	53,88	56,33	MPC (€/m ²)
		350,63	378,30	350,63	378,30	350,63	405,99	424,44	405,99	424,44	MPC (Kn/m ²)
		497190	497122	497150	497130	497067	497151	497119	497153	497121	Šif. / Dostupnost

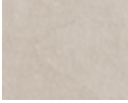

Pod LEA Waterfall | Silver Flow | 100x300 | Naturale
Zid Waterfall | Silver Flow | 100x300 | Naturale



								Format (cm)	
	90x90	50x100	100x100	100x300	60x60	45x90	90x90	Format (cm)	
	9,5	5,5	5,5	5,5	20	20	20	Debljina (mm)	
	Naturale	Lappato	Naturale	Naturale	Grip	Grip	Grip	Završna obrada	
	R10 B		R10	R10	R11 C	R11 C	R11 C	Protukliznost	
	53,88	56,33	90,62	90,62	90,62	80,83	83,27	86,95	MPC (€/m ²)
	405,99	424,44	682,79	682,79	682,79	608,98	627,43	655,11	MPC (Kn/m ²)
	497161	497128	550351	550349	550350	550390	497109	603581	Šif. / Dostupnost
	53,88	56,33	90,62	90,62	90,62	80,83	83,27	86,95	MPC (€/m ²)
	405,99	424,44	682,79	682,79	682,79	608,98	627,43	655,11	MPC (Kn/m ²)
	497164	497133	550353	550352	498053	550391	497110	603582	Šif. / Dostupnost
	53,88	56,33	90,62	90,62	90,62	80,83	83,27	86,95	MPC (€/m ²)
	405,99	424,44	682,79	682,79	682,79	608,98	627,43	655,11	MPC (Kn/m ²)
	497157	497124	550346	550347	550348	550389	497108	603580	Šif. / Dostupnost
	53,88	56,33	90,62	90,62	90,62	80,83	83,27	86,95	MPC (€/m ²)
	405,99	424,44	682,79	682,79	682,79	608,98	627,43	655,11	MPC (Kn/m ²)
	497152	497120	550343	550344	550345	550388	497107	603579	Šif. / Dostupnost



LEA Waterfall | Dark Flow | 60x60 | Lappato

REX LA ROCHE



Pod REX La Roche | Mud | 80x80 | Naturale
Zid REX La Roche | Mud | Modulo Muretto 3D | 30x30 | Naturale

Prilikom narudžbe ploča velikih formata (120x240, 120x280),
naplaćuje se paleta. Po povratu palete, vrši se povrat novca.



Blanc



Ecrú

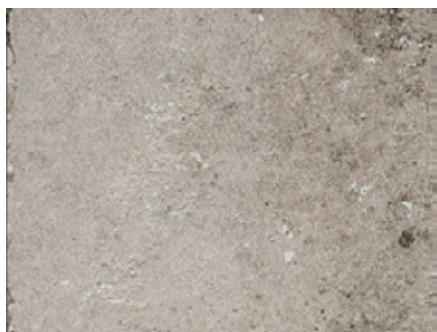

Grey

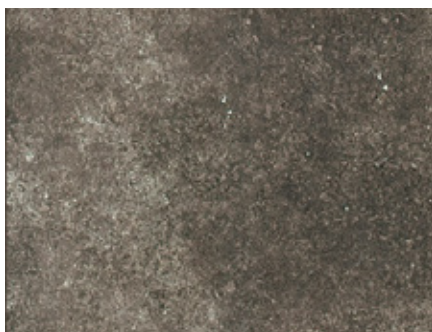

Mud









Antikni kamen s gustim slojevima poslužio je kao inspiracija za kolekciju La Roche di Rex. Kombinacija tamnih i svijetlih tonova na pločici daju osjećaj dubine i slojevitosti.

Pločice s posebnim šarmom dolaze i u velikim dimenzijama te čak tri različite završne obrade.



REX La Roche | Ecrú | 40x80 | Naturale

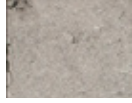







REX LA ROCHE

								
		60x60	60x120	40x80	80x80	Format (cm)		
		9	9	9	9	Debljina (mm)		
		Naturale	Naturale	Naturale	Strutturato	Naturale	Završna obrada	
		R10 A	R10 A	R10 A	R11 B	R10 A	R9	
							Protukliznost	
	Blanc	57,08	82,25	45,66	45,66	57,26	71,58	MPC (€/m ²)
		430,08	619,69	344,06	344,06	431,44	539,30	MPC (Kn/m ²)
		364591	364587	364579/L	364583/L	364571/L	364575	Šif. / Dostupnost
	Ecrú	57,08	82,25	45,66	45,66	57,26	71,58	MPC (€/m ²)
		430,08	619,69	344,06	344,06	431,44	539,30	MPC (Kn/m ²)
		364592	364588	364580/L	364585/L	364572/L	364577	Šif. / Dostupnost
	Grey	57,08	82,25	57,08	57,08	71,58	71,58	MPC (€/m ²)
		430,08	619,69	430,08	430,08	539,30	539,30	MPC (Kn/m ²)
		364593	364589	364581	364584	364573	364576	Šif. / Dostupnost
	Mud	57,08	82,25	57,08	57,08	71,58	71,58	MPC (€/m ²)
		430,08	619,69	430,08	430,08	539,30	539,30	MPC (Kn/m ²)
		364594	364590	364582	364586	364574	364578	Šif. / Dostupnost



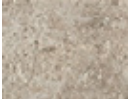
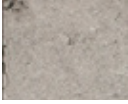

REX La Roche | Grey | 80x80 | Naturale

							
	60x120	120x120	120x240	120x280	60x60	40x120	Format (cm)
	6	6	6	6	20	20	Debljina (mm)
	Smooth	Smooth	Smooth	Smooth	Strutturato	Strutturato	Završna obrada
					R11 B	R11 B	Protukliznost
	94,84	96,11	118,69	125,13			MPC (€/m ²)
	714,60	724,14	894,23	942,82			MPC (Kn/m ²)
	436471	436468	436465	574620			Šif. / Dostupnost
	94,84	96,11	118,69	125,13	80,17	112,87	MPC (€/m ²)
	714,60	724,14	894,23	942,82	604,02	850,39	MPC (Kn/m ²)
	436473	436470	436467	574622	436474	436476	Šif. / Dostupnost
	94,84	96,11	118,69	125,13	80,17	112,87	MPC (€/m ²)
	714,60	724,14	894,23	942,82	604,02	850,39	MPC (Kn/m ²)
	436472	436469	436466	574621	436475	436477	Šif. / Dostupnost
							MPC (€/m ²)
							MPC (Kn/m ²)
							Šif. / Dostupnost



REX La Roche | Ecrú | 40x80 | Naturale

REX MATIERES



REX Matieres | Brun | 60x120 | Naturale

Prilikom narudžbe ploča velikih formata (120x240, 120x280), naplaćuje se paleta. Po povratu palete, vrši se povrat novca.



REX Matieres | Mou | 60x120 | Naturale



Sable

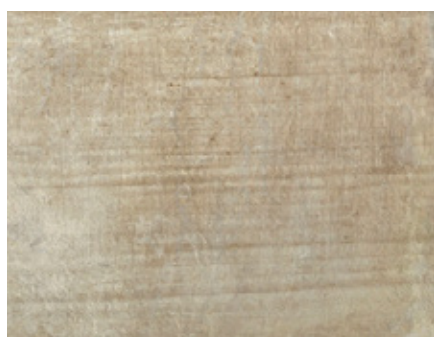

Mou

Autentičan izgled pločice iz kolekcije Matieres nudi stilsku svestranost. Izgled ove pločice savršeno se uklapa u moderan dizajn, ali i u prostore s vintage uređenjem.

Šest nijansi boja, zasebno ili u kombinaciji jedna s drugom, mogu stvoriti zanimljive dekorativne kompozicije.

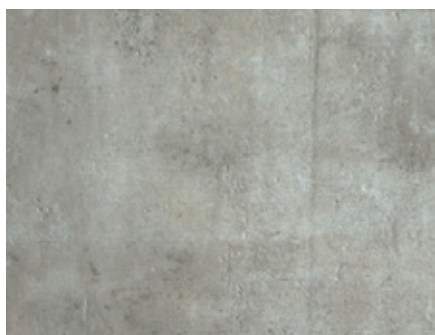

Nuage

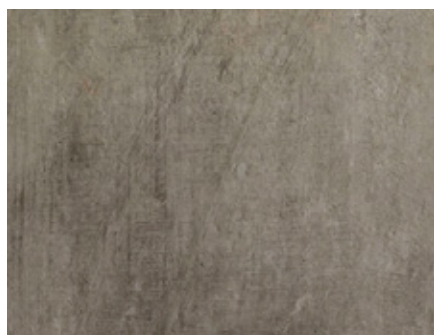

Gris

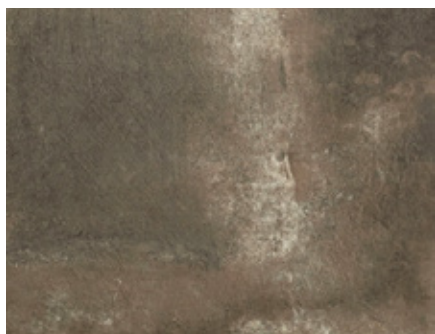

Brun



Barrique



Pod REX Matieres | Gris | 80x80 | Naturale
Zid REX Matieres | Gris | 80x80 | Naturale



**REX
MATIERES**

								Format (cm)
		30x60	60x60	60x120	40x80		80x80	Format (cm)
		9	9	9	9		9	Debljina (mm)
		Naturale	Naturale	Naturale	Naturale	Strutturato	Naturale	Završna obrada
		R10 B	R10 B	R10 B	R10 B	R11 C	R10 B	Protukliznost
	Sable	53,53	57,08	82,52	57,08	57,08	71,58	MPC (€/m ²)
		403,28	430,08	619,69	430,08	430,08	539,30	MPC (Kn/m ²)
		547604	547598	547574	547586	547592	547580	Šif. / Dostupnost
	Mou	53,53	57,08	82,52	57,08	57,08	71,58	MPC (€/m ²)
		403,28	430,08	619,69	430,08	430,08	539,30	MPC (Kn/m ²)
		547605	547599	547575	547587	547593	547581	Šif. / Dostupnost
	Nuage	53,53	57,08	82,52	57,08	57,08	71,58	MPC (€/m ²)
		403,28	430,08	619,69	430,08	430,08	539,30	MPC (Kn/m ²)
		547607	547601	547577	547589	547595	547583	Šif. / Dostupnost
	Gris	53,53	57,08	82,52	57,08	57,08	71,58	MPC (€/m ²)
		403,28	430,08	619,69	430,08	430,08	539,30	MPC (Kn/m ²)
		547606	547600	547576	547588	547594	547582	Šif. / Dostupnost
	Brun	53,53	57,08	82,52	45,66	57,08	57,26	MPC (€/m ²)
		403,28	430,08	619,69	344,06	430,08	431,44	MPC (Kn/m ²)
		547608	547602	547578	547590/Ⓛ	547596	547584/Ⓛ	Šif. / Dostupnost
	Barrique	53,53	57,08	82,52	57,08	57,08	71,58	MPC (€/m ²)
		403,28	430,08	619,69	430,08	430,08	539,30	MPC (Kn/m ²)
		547609	547603	547579	547591	547597	547585	Šif. / Dostupnost

									Format (cm)
		60x120	120x120	120x240	120x280	20,2x20,2	20,2x30,4	60x120	Format (cm)
		6	6	6	9	20	20	20	Debljina (mm)
		Naturale	Naturale	Naturale	Naturale	Strutturato	Strutturato	Strutturato	Završna obrada
		R9 A	R9 A	R9 A	R9 A	R11 C	R11 C	R11 C	Protukliznost
		94,84	96,11	118,69	125,13	112,87	112,87	118,56	MPC (€/m ²)
		714,60	724,14	894,23	942,82	850,39	850,39	893,31	MPC (Kn/m ²)
		547682	547674	547670	547666	547610	547614	849107	Šif. / Dostupnost
		94,84	96,11	118,69	125,13	112,87	112,87		MPC (€/m ²)
		714,60	724,14	894,23	942,82	850,39	850,39		MPC (Kn/m ²)
		547685	547677	547673	547669	547613	547617		Šif. / Dostupnost
		94,84	96,11	118,69	125,13	112,87	112,87	118,56	MPC (€/m ²)
		714,60	724,14	894,23	942,82	850,39	850,39	893,31	MPC (Kn/m ²)
		547683	547675	547671	547667	547612	547616	849106	Šif. / Dostupnost
		94,84	96,11	118,69	125,13	112,87	112,87		MPC (€/m ²)
		714,60	724,14	894,23	942,82	850,39	850,39		MPC (Kn/m ²)
		547684	547676	547672	547668	547611	547615		Šif. / Dostupnost
								118,56	MPC (€/m ²)
								893,31	MPC (Kn/m ²)
								849105	Šif. / Dostupnost
									MPC (€/m ²)
									MPC (Kn/m ²)
									Šif. / Dostupnost

PRISSMACER BLANCO

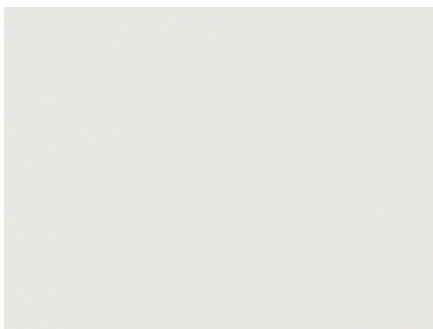

Blanco

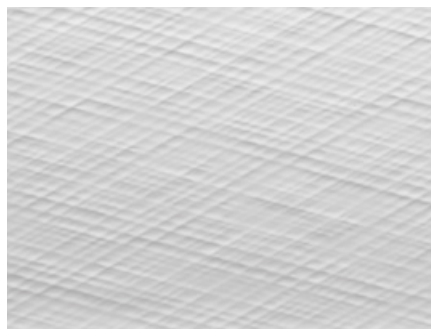

Ketu rlv.

Prissmacer bijele pločice nepogrešivi su klasik. U skladu sa suvremenim trendovima uređenja, ni malo dosadne, u kombinaciji s lijepim dekorima ponovno se izdvajaju.

Svestrane pločice u bijeloj boji odaju dojam čistoće i mirnoće prostora.



Crux rlv.



Ara rlv.

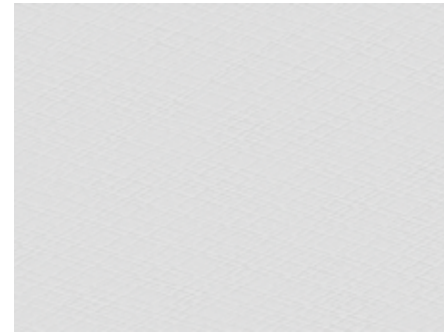

Atik rlv.

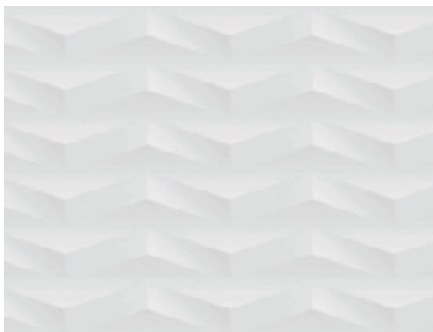

Leo rlv.



Lupi rlv.

**PRISSMACER
BLANCO**

		□ 20x20 7		□ 20x60 9,4		□ 30x90 10,5		□ 40x120 11		Format (cm)
										Debljina (mm)
		Naturale	Brillo	Naturale	Brillo	Naturale	Brillo	Naturale	Brillo	Završna obrada
										Protukliznost
	Blanco	15,74	15,74	15,74	15,74		23,60		27,84	MPC (€/m ²)
		118,56	118,56	118,56	118,56		177,84		209,76	MPC (Kn/m ²)
		611756/Ⓛ	611755/Ⓛ	611754/Ⓛ	611753/Ⓛ		612333/Ⓛ		611752/Ⓛ	Šif. / Dostupnost
	Ketu rlv.				31,02					MPC (€/m ²)
					233,70					MPC (Kn/m ²)
					612339					Šif. / Dostupnost
	Crux rlv.			31,02						MPC (€/m ²)
				233,70						MPC (Kn/m ²)
				612338						Šif. / Dostupnost
	Ara rlv.				31,02					MPC (€/m ²)
					233,70					MPC (Kn/m ²)
					612340					Šif. / Dostupnost
	Atik rlv.					31,02	36,31			MPC (€/m ²)
						273,60	273,60			MPC (Kn/m ²)
						612332	612335			Šif. / Dostupnost
	Leo rlv.							42,37		MPC (€/m ²)
								319,20		MPC (Kn/m ²)
								612327		Šif. / Dostupnost
	Lupi rlv.								42,37	MPC (€/m ²)
								319,20		MPC (Kn/m ²)
								612329		Šif. / Dostupnost

EQUIPE ARROW

Pločice neobičnog i zanimljivog oblika nude različite načine postavljanja te garantiraju pravo osvježanje prostora.

Širok izbor boja nudi i mogućnosti kombiniranja, pa tako svaki zid lako može postati pravo umjetničko djelo.



EQUIPE ARROW



		5x25	Format (cm)
		8,8	Debljina (mm)
		Brillo	Završna obrada
			Protukliznost
	Pure White	55,49	MPC (€/m ²)
		418,08	MPC (Kn/m ²)
		827259	Šifra artikla
	Blush Pink	55,49	MPC (€/m ²)
		418,08	MPC (Kn/m ²)
		827253	Šifra artikla
	Gardenia Cream	55,49	MPC (€/m ²)
		418,08	MPC (Kn/m ²)
		827256	Šifra artikla
	Green Halite	55,49	MPC (€/m ²)
		418,08	MPC (Kn/m ²)
		827257	Šifra artikla
	Quicksilver	55,49	MPC (€/m ²)
		418,08	MPC (Kn/m ²)
		827260	Šifra artikla
	Caribbean Blue	55,49	MPC (€/m ²)
		418,08	MPC (Kn/m ²)
		827254	Šifra artikla
	Blue Velvet	55,49	MPC (€/m ²)
		418,08	MPC (Kn/m ²)
		827252	Šifra artikla



		5x25	Format (cm)
		8,8	Debljina (mm)
		Brillo	Završna obrada
			Protukliznost
	Adriatic Blue	55,49	MPC (€/m ²)
		418,08	MPC (Kn/m ²)
		827249	Šifra artikla
	Blue Canard	55,49	MPC (€/m ²)
		418,08	MPC (Kn/m ²)
		824245	Šifra artikla
	Green Kelp	55,49	MPC (€/m ²)
		418,08	MPC (Kn/m ²)
		827258	Šifra artikla
	Apple	55,49	MPC (€/m ²)
		418,08	MPC (Kn/m ²)
		827250	Šifra artikla
	Coffee	55,49	MPC (€/m ²)
		418,08	MPC (Kn/m ²)
		827255	Šifra artikla
	Russet	55,49	MPC (€/m ²)
		418,08	MPC (Kn/m ²)
		827261	Šifra artikla
	Black	55,49	MPC (€/m ²)
		418,08	MPC (Kn/m ²)
		827251	Šifra artikla

EQUIPE ART NOUVEAU





Dekoratívne pločice s mnogo mogućnosti i dezena pomalo podsjećaju na vintage stil. Bilo da želite u boji, crno bijele ili sive tonove,

Art Nouveau pruža zaista mnogo mogućnosti pri odabiru. Pločice formata 20x20 vratit će vas u prošlost i u stilove kakvi su nekada bili trend, a danas se ponovno vraćaju.





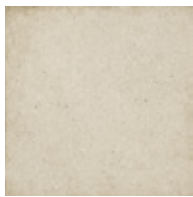

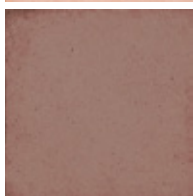
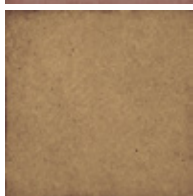
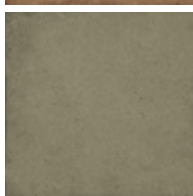
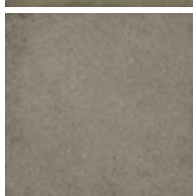
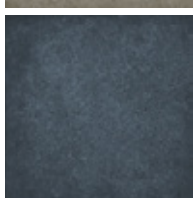
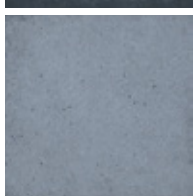

Pod EQUIPE Art Nouveau | Bone, Gray, Karlsplatz Grey | 20x20 | Naturale

EQUIPE ART NOUVEAU



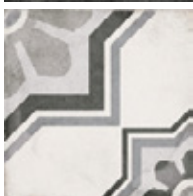
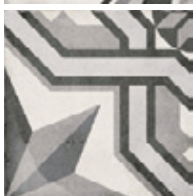
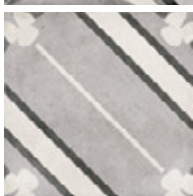
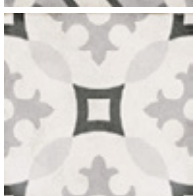

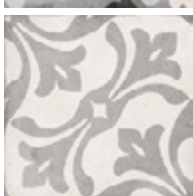



			
		20x20	Format (cm)
		8,8	Debljina (mm)
		Naturale	Završna obrada
		R9 A	Protukliznost
	Bone	51,52	MPC (€/m ²)
		388,19	MPC (Kn/m ²)
		582938	Šifra artikla
	Biscuit	51,52	MPC (€/m ²)
		388,19	MPC (Kn/m ²)
		584706	Šifra artikla
	Coral Pink	51,52	MPC (€/m ²)
		388,19	MPC (Kn/m ²)
		584704	Šifra artikla
	Burgundy	51,52	MPC (€/m ²)
		388,19	MPC (Kn/m ²)
		584710	Šifra artikla
	Siena	51,52	MPC (€/m ²)
		388,19	MPC (Kn/m ²)
		584707	Šifra artikla
	Cypress Green	51,52	MPC (€/m ²)
		388,19	MPC (Kn/m ²)
		584712	Šifra artikla
	Tobacco	51,52	MPC (€/m ²)
		388,19	MPC (Kn/m ²)
		584709	Šifra artikla
	Navy Blue	51,52	MPC (€/m ²)
		388,19	MPC (Kn/m ²)
		584713	Šifra artikla
	Woad Blue	51,52	MPC (€/m ²)
		388,19	MPC (Kn/m ²)
		584708	Šifra artikla







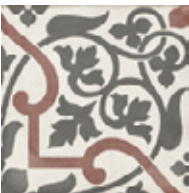

			
		20x20	Format (cm)
		8,8	Debljina (mm)
		Naturale	Završna obrada
		R9 A	Protukliznost
	Sky Blue	51,52	MPC (€/m ²)
		388,19	MPC (Kn/m ²)
		584705	Šifra artikla
	Grey	51,52	MPC (€/m ²)
		388,19	MPC (Kn/m ²)
		584711	Šifra artikla
	Charcoal Grey	51,52	MPC (€/m ²)
		388,19	MPC (Kn/m ²)
		584714	Šifra artikla
	Capitol Grey	59,43	MPC (€/m ²)
		447,78	MPC (Kn/m ²)
		584715	Šifra artikla
	Cinema Grey	59,43	MPC (€/m ²)
		447,78	MPC (Kn/m ²)
		584716	Šifra artikla
	Inspire Grey	59,43	MPC (€/m ²)
		447,78	MPC (Kn/m ²)
		584719	Šifra artikla
	Karsplatz Grey	59,43	MPC (€/m ²)
		447,78	MPC (Kn/m ²)
		584717	Šifra artikla
	Opera Grey	59,43	MPC (€/m ²)
		447,78	MPC (Kn/m ²)
		584720	Šifra artikla
	La Ramla Grey	59,43	MPC (€/m ²)
		447,78	MPC (Kn/m ²)
		584718	Šifra artikla



EQUIPE ART NOUVEAU

			
		20x20	Format (cm)
		8,8	Debljina (mm)
		Naturale	Završna obrada
		R9 A	Protukliznost
	Padua Black	59,43 447,78	MPC (€/m ²) MPC (Kn/m ²)
		579014	Šifra artikla
	Lys Colour	59,43 447,78	MPC (€/m ²) MPC (Kn/m ²)
		584732	Šifra artikla
	Empire Colour	59,43 447,78	MPC (€/m ²) MPC (Kn/m ²)
		584722	Šifra artikla
	Apollo Colour	59,43 447,78	MPC (€/m ²) MPC (Kn/m ²)
		584723	Šifra artikla
	Majestic Colour	59,43 447,78	MPC (€/m ²) MPC (Kn/m ²)
		584724	Šifra artikla
	Folies Bergere	59,43 447,78	MPC (€/m ²) MPC (Kn/m ²)
		578865	Šifra artikla
	Turin Colour	59,43 447,78	MPC (€/m ²) MPC (Kn/m ²)
		584725	Šifra artikla



			
		20x20	Format (cm)
		8,8	Debljina (mm)
		Naturale	Završna obrada
		R9 A	Protukliznost
	Viena Colour	59,43 447,78	MPC (€/m ²) MPC (Kn/m ²)
		584730	Šifra artikla
	Music Hall	59,43 447,78	MPC (€/m ²) MPC (Kn/m ²)
		584733	Šifra artikla
	Palais Blue	59,43 447,78	MPC (€/m ²) MPC (Kn/m ²)
		584728	Šifra artikla
	Arcada Blue	59,43 447,78	MPC (€/m ²) MPC (Kn/m ²)
		582937	Šifra artikla
	La Rambla Biscuit	59,43 447,78	MPC (€/m ²) MPC (Kn/m ²)
		584727	Šifra artikla
	Padua Pink	59,43 447,78	MPC (€/m ²) MPC (Kn/m ²)
		584726	Šifra artikla
	Embassy Colour	59,43 447,78	MPC (€/m ²) MPC (Kn/m ²)
		584731	Šifra artikla

EQUIPE ARTISAN

Pločice inspirirane arapskim stilom, sa svojim neravninama na površini, pomalo podsjećaju na opeku.

Glatke površine i decentnog sjaja, ove pločice savršeno se kombiniraju s drugim pločicama.





EQUIPE Artisan | Rose Mallow | 6,5x20 | Brillo

**EQUIPE
ARTISAN**

				Format (cm)
		8,8	8,8	Debljina (mm)
		Brillo	Brillo	Završna obrada
				Protukliznost
	White	51,52 388,19	51,52 388,19	MPC (€/m ²) MPC (Kn/m ²)
		604440	583925	Šifra artikla
	Ochre	51,52 388,19	51,52 388,19	MPC (€/m ²) MPC (Kn/m ²)
		578701	827283	Šifra artikla
	Rose Mallow	51,52 388,19	51,52 388,19	MPC (€/m ²) MPC (Kn/m ²)
		578702	578445	Šifra artikla
	Burgundy	51,52 388,19	51,52 388,19	MPC (€/m ²) MPC (Kn/m ²)
		578706	578441	Šifra artikla
	Gold	87,17 656,81	87,17 656,81	MPC (€/m ²) MPC (Kn/m ²)
		582956	605995	Šifra artikla

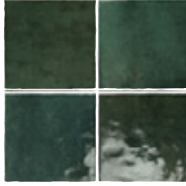
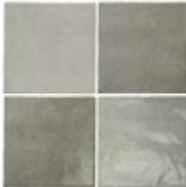
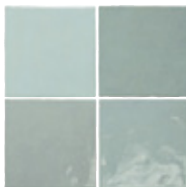
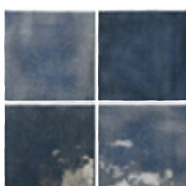
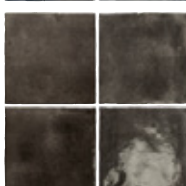

				Format (cm)
		8,8	8,8	Debljina (mm)
		Brillo	Brillo	Završna obrada
				Protukliznost
	Moss Green	51,52 388,19	51,52 388,19	MPC (€/m ²) MPC (Kn/m ²)
		582933	578444	Šifra artikla
	Alabaster	51,52 388,19	51,52 388,19	MPC (€/m ²) MPC (Kn/m ²)
		578703	583193	Šifra artikla
	Aqua	51,52 388,19	51,52 388,19	MPC (€/m ²) MPC (Kn/m ²)
		578704	578440	Šifra artikla
	Colonial Blue	51,52 388,19	51,52 388,19	MPC (€/m ²) MPC (Kn/m ²)
		578705	583922	Šifra artikla
	Graphite	51,52 388,19	51,52 388,19	MPC (€/m ²) MPC (Kn/m ²)
		605997	605996	Šifra artikla

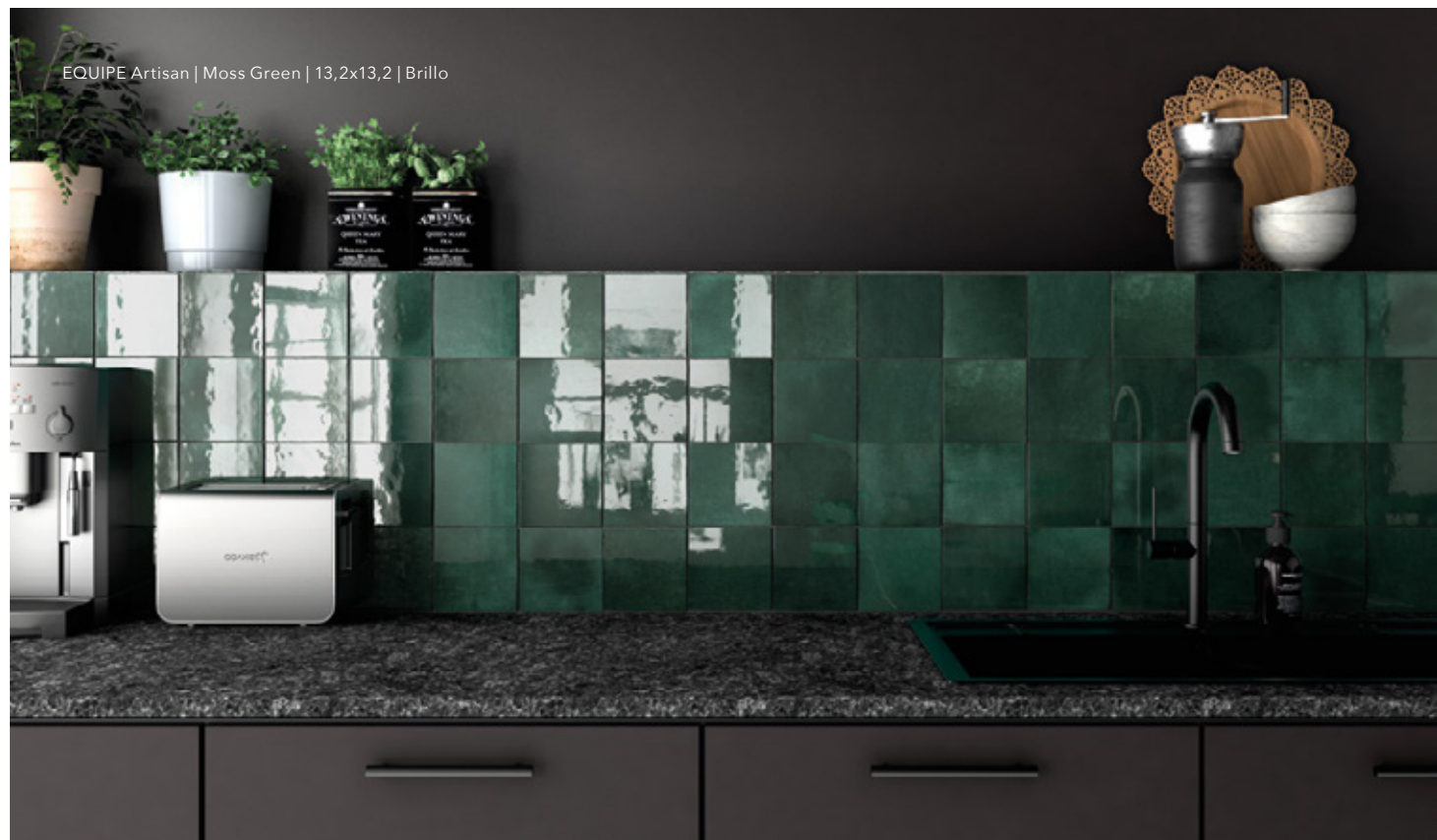

EQUIPE Artisan | Moss Green | 13,2x13,2 | Brillo

EQUIPE MALLORCA

Divna kolekcija Mallorca donosi dašak morskog duha radi svojeg sedefastog odsjaja na površini pločica koji podsjeća na unutrašnjost školjke.

Zidovi vašeg interijera zasjat će u drugačijem, posebnom sjaju.



**EQUIPE
MALLORCA**

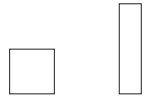

10x10	6,5x20	Format (cm)	
8,8	8,8	Debljina (mm)	
Satinado	Satinado	Završna obrada	
		Protukliznost	
White	51,52 388,19	51,52 388,19	MPC (€/m ²) MPC (Kn/m ²)
	486217	486247	Šifra artikla
	Cream	51,52 388,19	51,52 388,19
486214		486244	Šifra artikla
Green		51,52 388,19	51,52 388,19
	486215	486245	Šifra artikla



10x10	6,5x20	Format (cm)	
8,8	8,8	Debljina (mm)	
Satinado	Satinado	Završna obrada	
		Protukliznost	
Blue	51,52 388,19	51,52 388,19	MPC (€/m ²) MPC (Kn/m ²)
	486213	486243	Šifra artikla
	Grey	51,52 388,19	51,52 388,19
486216		486246	Šifra artikla
Black		55,49 418,08	55,49 418,08
	486212	486242	Šifra artikla



EQUIPE Mallorca | Black | 10x10 | Naturale

EQUIPE CHEVRON WALL

Osim što su zidne pločice malih formata postale poželjne, rado je viđeno i chevron slaganje.

Različite varijante slaganja i mnoge boje u kojima pločice dolaze, daju mogućnost igranja s dizajnom.



EQUIPE Chevron Wall | Greige | 18,6x5,2 | Naturale

EQUIPE CHEVRON WALL

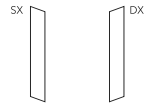

		18,6x5,2	18,6x5,2	Format (cm)
		8,8	8,8	Debljina (mm)
		Brillo	Brillo	Završna obrada
				Protukljiznost
	White Matt	51,52 388,19	51,52 388,19	MPC (€/m ²) MPC (Kn/m ²)
		486069	486070	Šifra artikla
	White	51,52 388,19	51,52 388,19	MPC (€/m ²) MPC (Kn/m ²)
		486068	486071	Šifra artikla
	Cream	51,52 388,19	51,52 388,19	MPC (€/m ²) MPC (Kn/m ²)
		486056	486057	Šifra artikla
	Greige	51,52 388,19	51,52 388,19	MPC (€/m ²) MPC (Kn/m ²)
		486060	486061	Šifra artikla
	Mint	51,52 388,19	51,52 388,19	MPC (€/m ²) MPC (Kn/m ²)
		486064	486065	Šifra artikla

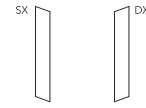

		18,6x5,2	18,6x5,2	Format (cm)
		8,8	8,8	Debljina (mm)
		Brillo	Brillo	Završna obrada
				Protukljiznost
	Sky Blue	51,52 388,19	51,52 388,19	MPC (€/m ²) MPC (Kn/m ²)
		486066	486067	Šifra artikla
	Light Grey	51,52 388,19	51,52 388,19	MPC (€/m ²) MPC (Kn/m ²)
		486062	486063	Šifra artikla
	Dark Grey	51,52 388,19	51,52 388,19	MPC (€/m ²) MPC (Kn/m ²)
		486058	486059	Šifra artikla
	Black Matt	55,49 418,08	55,49 418,08	MPC (€/m ²) MPC (Kn/m ²)
		486053	486054	Šifra artikla
	Black	55,49 418,08	55,49 418,08	MPC (€/m ²) MPC (Kn/m ²)
		486052	486055	Šifra artikla

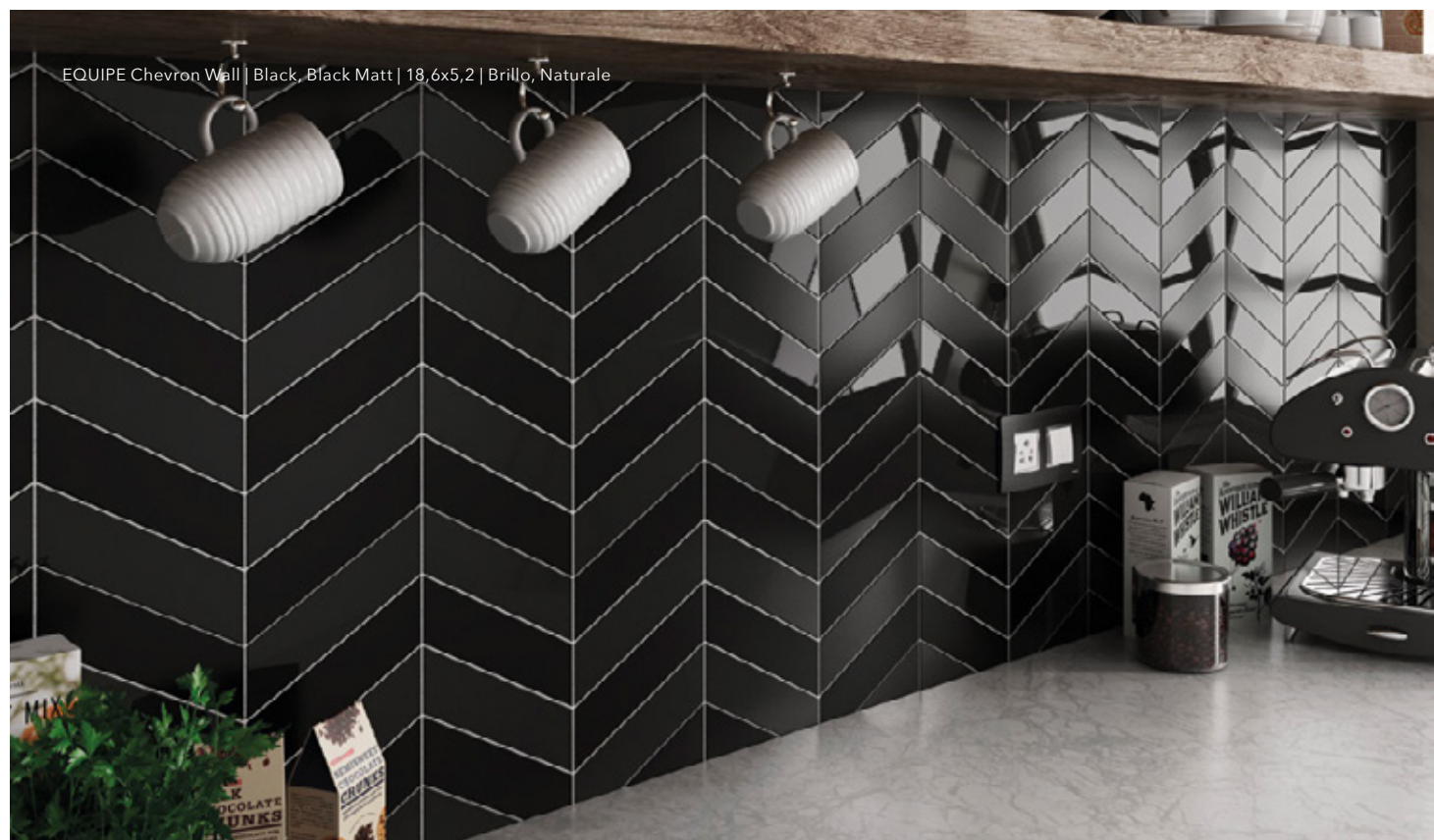

EQUIPE SCALE

Kolekcija Scale donosi nekonvencionalne oblike pločica koji garantiraju wow efekt. Osim što su u ponudi nesvakidašnji oblici, tu je i mnogo boja u kojima dolaze.

Prikladne su jednako za kuhinju, kupaonicu ili za zid kojim želite osvježiti svoj prostor.



EQUIPE Scale | Alhambra Electric Blue | 12x12 | Glossy

EQUIPE
SCALE



Alhamb.	Fan	Dekor
12x12	10,6x12	Format (cm)
8,8	8,8	Debljina (mm)
Brillo	Brillo	Završna obrada
		Protukliznost

	White Matt	132,07	148,59	MPC (€/m ²)
		995,05	1.119,53	MPC (Kn/m ²)
		427573	427559	Šifra artikla
	White	132,07	148,59	MPC (€/m ²)
		995,05	1.119,53	MPC (Kn/m ²)
		427572	427558	Šifra artikla
	Cream	132,07	148,59	MPC (€/m ²)
		995,05	1.119,53	MPC (Kn/m ²)
		427570	427556	Šifra artikla
	Greige	132,07	148,59	MPC (€/m ²)
		995,05	1.119,53	MPC (Kn/m ²)
		486327	486318	Šifra artikla
	Mint	132,07	148,59	MPC (€/m ²)
		995,05	1.119,53	MPC (Kn/m ²)
		486328	486319	Šifra artikla
	Sky Blue	132,07	148,59	MPC (€/m ²)
		995,05	1.119,53	MPC (Kn/m ²)
		486329	486320	Šifra artikla



Alhamb.	Fan	Dekor
12x12	10,6x12	Format (cm)
8,8	8,8	Debljina (mm)
Brillo	Brillo	Završna obrada
		Protukliznost

	Light Grey	132,07	148,59	MPC (€/m ²)
		995,05	1.119,53	MPC (Kn/m ²)
		427571	427557	Šifra artikla
	Dark Grey	132,07	148,59	MPC (€/m ²)
		995,05	1.119,53	MPC (Kn/m ²)
		427569	427555	Šifra artikla
	Black Matt	132,07	148,59	MPC (€/m ²)
		995,05	1.119,53	MPC (Kn/m ²)
		427568	427554	Šifra artikla
	Black	132,07	148,59	MPC (€/m ²)
		995,05	1.119,53	MPC (Kn/m ²)
		427567	427553	Šifra artikla
	Electric Blue	148,59	168,40	MPC (€/m ²)
		1.119,53	1.268,79	MPC (Kn/m ²)
		596778	578753	Šifra artikla
	Metallic	148,59	168,40	MPC (€/m ²)
		1.119,53	1.268,79	MPC (Kn/m ²)
		827687	819975	Šifra artikla



EQUIPE Scale | Fan Black | 10,6x12 | Naturale







MUTINA AZULEJ

Kolekcija Azulej donosi pregršt uzoraka i zanimljivih oblika na površini pločice, koji si na prvu međusobno ne pašu, no daljnjim gledanjem zapravo si savršeno pristaju.

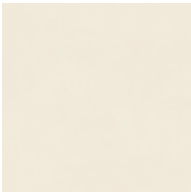



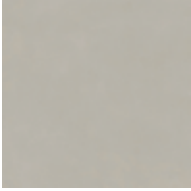
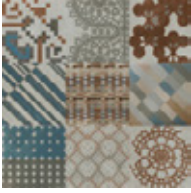

Inovativne i moderne, radi svoje dimenzije nas vraćaju u prošlost kada je ovaj format bio jedina opcija.

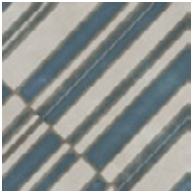
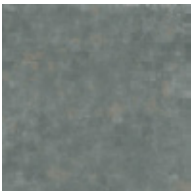

**MUTINA
AZULEJ**

			
		20x20	Format (cm)
		10	Debljina (mm)
		Naturale	Završna obrada
		R9	Protukliznost
	Bianco	141,07 1.062,91	MPC (€/m ²) MPC (Kn/m ²)
		433036	Šifra artikla
	Combination Bianco	186,09 1.402,09	MPC (€/m ²) MPC (Kn/m ²)
		433048	Šifra artikla
	Gira Bianco	186,09 1.402,09	MPC (€/m ²) MPC (Kn/m ²)
		433039	Šifra artikla
	Renda Bianco	186,09 1.402,09	MPC (€/m ²) MPC (Kn/m ²)
		433040	Šifra artikla
	Trevo Bianco	186,09 1.402,09	MPC (€/m ²) MPC (Kn/m ²)
		433041	Šifra artikla
	Grigio	141,07 1.062,91	MPC (€/m ²) MPC (Kn/m ²)
		433037	Šifra artikla
	Combination Grigio	186,09 1.402,09	MPC (€/m ²) MPC (Kn/m ²)
		433060	Šifra artikla
	Estrela Grigio	186,09 1.402,09	MPC (€/m ²) MPC (Kn/m ²)
		433056	Šifra artikla

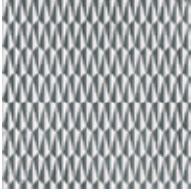

			
		20x20	Format (cm)
		10	Debljina (mm)
		Naturale	Završna obrada
		R9	Protukliznost
	Flores Grigio	186,09 1.402,09	MPC (€/m ²) MPC (Kn/m ²)
		433057	Šifra artikla
	Diagonal Grigio	186,09 1.402,09	MPC (€/m ²) MPC (Kn/m ²)
		433058	Šifra artikla
	Nero	141,07 1.062,91	MPC (€/m ²) MPC (Kn/m ²)
		433038	Šifra artikla
	Combination Nero	186,09 1.402,09	MPC (€/m ²) MPC (Kn/m ²)
		433071	Šifra artikla
	Trama Nero	186,09 1.402,09	MPC (€/m ²) MPC (Kn/m ²)
		433064	Šifra artikla
	Cubo Nero	186,09 1.402,09	MPC (€/m ²) MPC (Kn/m ²)
		433065	Šifra artikla
	Prata Nero	186,09 1.402,09	MPC (€/m ²) MPC (Kn/m ²)
		433066	Šifra artikla







MUTINA DECHIRER

Dechirer je kolekcija koja oduzima dah. Zid će vam, uz ovu pločicu, djelovati kao da ga je netko ručno rezbario i lijepio na njega komadiće čipke.



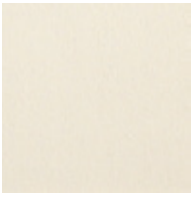

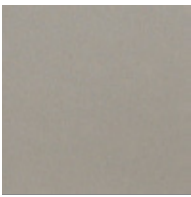

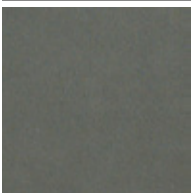
Elegantna, posebna pločica, stvara moderan i nježan izgled u kojem god prostoru se nalazi.



MUTINA DECHIRER

				
	60x60	60x120	120x120	Format (cm)
	12	12	12	Debljina (mm)
	Naturale	Naturale	Naturale	Završna obrada
	R10	R10	R10	Protukliznost
	191,14 1.440,14	236,13 1.779,14	308,44 2.323,95	MPC (€/m ²) MPC (Kn/m ²)
	433203	433185	433177	Šifra artikla
	199,23 1.501,06	246,77 1.859,26	322,11 2.426,94	MPC (€/m ²) MPC (Kn/m ²)
	394463	433182	433167	Šifra artikla
	191,14 1.440,14	236,13 1.779,14	308,44 2.323,95	MPC (€/m ²) MPC (Kn/m ²)
	433205	433187	433179	Šifra artikla
	199,23 1.501,06	246,77 1.859,26	322,11 2.426,94	MPC (€/m ²) MPC (Kn/m ²)
	394464	394465	433169	Šifra artikla
	199,23 1.501,06	236,13 1.779,14	308,44 2.323,95	MPC (€/m ²) MPC (Kn/m ²)
	433192	433189	433181	Šifra artikla

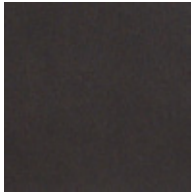
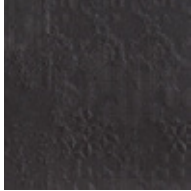
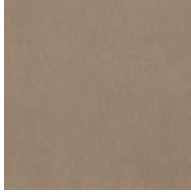
MUTINA DECHIRER

				
	60x60	60x120	120x120	Format (cm)
	12	12	12	Debljina (mm)
	Naturale	Naturale	Naturale	Završna obrada
	R10	R10	R10	Protukliznost
	331,95 1.501,06	246,77 1.859,26	322,11 2.426,94	MPC (€/m ²) MPC (Kn/m ²)
	433192	394466	433171	Šifra artikla
	191,14 1.440,14	236,13 1.779,14	308,44 2.323,95	MPC (€/m ²) MPC (Kn/m ²)
	433206	433188	433180	Šifra artikla
	199,23 1.501,06	246,77 1.859,26	322,11 2.426,94	MPC (€/m ²) MPC (Kn/m ²)
	433191	433184	433170	Šifra artikla
	191,14 1.440,14	236,13 1.779,14	308,44 2.323,95	MPC (€/m ²) MPC (Kn/m ²)
	433204	433186	433178	Šifra artikla
	199,23 1.501,06	246,77 1.859,26	322,11 2.426,94	MPC (€/m ²) MPC (Kn/m ²)
	433190	433183	433168	Šifra artikla



MUTINA Dechirer | Decor Nero | 60x120 | Naturale

BLUSTYLE **BARRIQUE**





Loire Cru



Rhone Cru



Alsace Cuvee



Provence Cuvee

Hrast, orah, bor i ariš stvaraju čarobnu atmosferu u svojem prirodnom okruženju pa su tako poslužili i kao inspiracija za stvaranje nove kolekcije gdje se imitira drvo.

Šarmantan izgled ovih pločica te rustikalni štih kakav stvaraju, oživljava pod bilo koje prostorije.







BLUSTYLE Barrique | Rhone Cru | 20x90 | Naturele



BLUSTYLE Barrique | Loire Cru | 20x90 | Naturele

BLUSTYLE BARRIQUE

		20x90	Format (cm)
		9,5	Debljina (mm)
		Naturele	Završna obrada
		R10 B	Protukliznost
	Loire Cru	32,33	MPC (€/m ²)
		243,59	MPC (Kn/m ²)
		390313/Ⓢ	Šif. / Dostupnost
	Rhone Cru	32,33	MPC (€/m ²)
		243,59	MPC (Kn/m ²)
		390315/Ⓢ	Šif. / Dostupnost
	Alsace Cuvee	40,41	MPC (€/m ²)
		304,49	MPC (Kn/m ²)
		390308	Šif. / Dostupnost
	Provence Cuvee	40,41	MPC (€/m ²)
		304,49	MPC (Kn/m ²)
		390314	Šif. / Dostupnost



CAESAR **ARTHIS**





Vapor



Natur

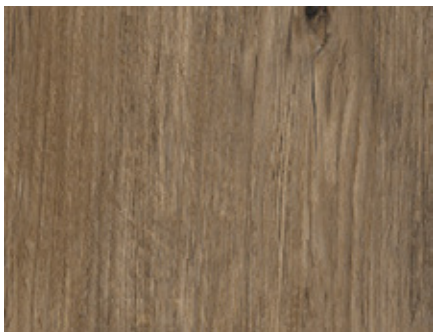

Oleum

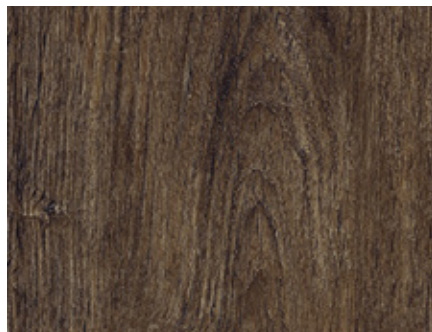

Royal







Plemenita umjetnost obrade drveta inspiracija je za iznimno lijepu kolekciju Arthis. Vještina majstora te zanimljive obrade koje se ručno dobivaju uspješno su imitirane Caesar pločicama.

Četiri boje u ponudi zadovoljit će svačije želje prilikom uređenja.

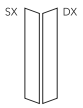

CAESAR Arthis | Natur | 20x120 | Naturale

CAESAR ARTHIS

					Dekor
		20x120	20x120	30x120	Format (cm)
		9	9	20	Debljina (mm)
		Naturale	Naturale	Grip	Završna obrada
		R9	R9	R11 C	Protukliznost
	Vapor	50,57	80,63	83,80	MPC (€/m ²)
		381,05	607,48	631,41	MPC (Kn/m ²)
		577321	577282	993890	Šif. / Dostupnost
	Natur	50,57	80,63	83,80	MPC (€/m ²)
		381,05	607,48	631,41	MPC (Kn/m ²)
		577322	577283	993891	Šif. / Dostupnost
	Oleum	50,57	80,63		MPC (€/m ²)
		381,05	607,48		MPC (Kn/m ²)
		577323	577280		Šif. / Dostupnost
	Royal	50,57	80,63		MPC (€/m ²)
		381,05	607,48		MPC (Kn/m ²)
		577324	577281		Šif. / Dostupnost



CAESAR FABULA



Pod CAESAR Fabula | Ulmus | 20x120 | Naturale
Zid CAESAR Fabula | Ulmus Chevron | 20x100 | Naturale

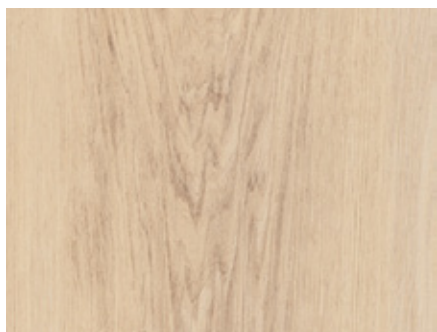

Robur



Ulmus

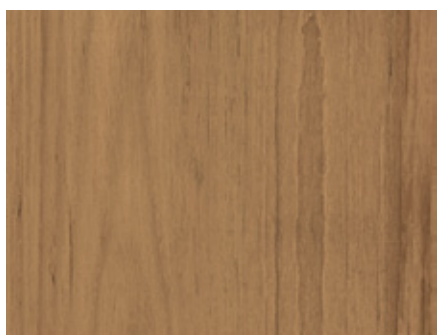

Theca





CAESAR Fabula | Robur Chevron | 20x120 | Naturale

Fabula je kolekcija pločica s efektom drveta koja ima za cilj unijeti toplinu i prirodnu eleganciju u različite arhitektonske ideje.

Svojim izborom dimenzija i boja, pruža se izbor za različite stilove uređenja.

**CAESAR
FABULA**



				Dekor
	20x120	20x120	5,7x60	Format (cm)
	9	9	9	Debljina (mm)
	Naturale	Naturale	Naturale	Završna obrada
	R9	R9	R9	Protukliznost
Robur	50,57	80,63	105,12	MPC (€/m ²)
	381,05	607,48	792,02	MPC (Kn/m ²)
	554306	554335	554311	Šif. / Dostupnost
Ulmus	50,57	80,63	105,12	MPC (€/m ²)
	381,05	607,48	792,02	MPC (Kn/m ²)
	554307	554336	554313	Šif. / Dostupnost
Theca	50,57	80,63	105,12	MPC (€/m ²)
	381,05	607,48	792,02	MPC (Kn/m ²)
	554309	554338	554312	Šif. / Dostupnost



CAESAR Fabula | Ulmus | 20x120 | Naturale

CAESAR **LIFE**





Nordic



Oak



Noce

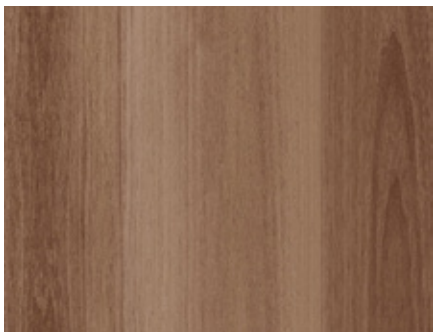

Walnut

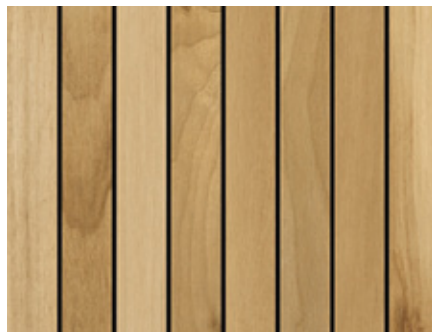









Oak Stave

Lijep dizajn i estetski sklad koji karakterizira prirodno drvo, kolekcija Life prenosi u svojih pet nijansi boja.

Reproducira karakteristične nijanse i žile prirodnog drva, a unutar Life kolekcije u ponudi su i pločice namijenjene za vanjsku upotrebu.

**CAESAR
LIFE**

								
		20x120		30x120		30x120		Dekor
		9		20		9		Format (cm)
		Naturale	Struktur.	Struktur.		Naturale		Završna obrada
		R9	R11 C	R11 C				Protukliznost
	Nordic	50,57						MPC (€/m ²)
		381,05						MPC (Kn/m ²)
		359664						Šif. / Dostupnost
	Oak	50,57	50,57	83,80	239,20			MPC (€/m ²)
		381,05	381,05	631,41	1.802,27			MPC (Kn/m ²)
		359665	359670	401965	359700			Šif. / Dostupnost
	Noce	50,57	50,57	83,80	239,20			MPC (€/m ²)
		381,05	381,05	631,41	1.802,27			MPC (Kn/m ²)
		359666	359671	401966	359701			Šif. / Dostupnost
	Walnut	50,57						MPC (€/m ²)
		381,05						MPC (Kn/m ²)
		359667						Šif. / Dostupnost

CAESAR MEET

Izgled drveta u kolekciji pločica Meet lijepo se kombinira s drugim materijalima u prostoru.

Šarmantan susret između prirodnog i pomalo istrošenog materijala donosi potpuno nov dojam te se prilagođava suvremenom i vintage uređenju.



Chic Beige



Allure Hazel



Scandi White



Eclectic Brown



Tarsia



Allure Hazel square



Allure Hazel stave



Pod CAESAR Meet | Eclectic Brown | 20x120 | Naturale
Dekor Tarsia | 20x20 | Naturale

**CAESAR
MEET**

			chevron			Squares	Squares	Stave	Dekor		
		20x20	20x120		20x120	30x120	60x60	80x80	30x120	Format (cm)	
		9	9		9	20	20	9	9	Debljina (mm)	
		Naturale	Naturale	Grip	Naturale	Struktur.	Struktur.	Naturale	Struktur.	Naturale	Završna obrada
		R9	R9	R11 C	R9	R11 C	R11 C	R9	R11 C	R9	Protukliznost
	Chic Beige		50,57	50,57	80,63	83,80		57,72		228,91	MPC (€/m ²)
			381,05	381,05	607,48	631,41		434,91		1.724,74	MPC (Kn/m ²)
			854894	854899	854902	854908		854914		854917	Šif. / Dostupnost
	Allure Hazel		50,57	50,57	80,63	83,80	71,76	57,72	83,80	228,91	MPC (€/m ²)
			381,05	381,05	607,48	631,41	540,65	434,91	631,41	1.724,74	MPC (Kn/m ²)
			854895	854898	854903	854909	854907	854915	887071	854918	Šif. / Dostupnost
	Scandi White		50,57	50,57	80,63					228,91	MPC (€/m ²)
			381,05	381,05	607,48					1.724,74	MPC (Kn/m ²)
			854896	854901	854904					854916	Šif. / Dostupnost
	Eclectic Brown		50,57	50,57	80,63					228,91	MPC (€/m ²)
			381,05	381,05	607,48					1.724,74	MPC (Kn/m ²)
			854897	854900	854905					854919	Šif. / Dostupnost
	Tarsia		76,79								MPC (€/m ²)
			578,55								MPC (Kn/m ²)
			854920								Šif. / Dostupnost

LEA BIO SELECT

Kolekcija koja nudi čak sedam boja, vjerno interpretira esencije drveta. Prigodna je za svakodnevna i poslovna okruženja radi nijansi koje unose toplinu prirodnog materijala.

Osim lijepe estetike, Bio Select odlična je kolekcija i radi širokog spektra boja, tri dimenzije, dvije završne obrade te dvije specijalne pločice.





Oak Vanilla



Oak Ginger



Oak Natural

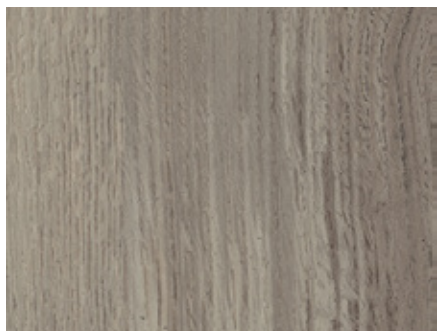

Oak Ash



Oak Cloves

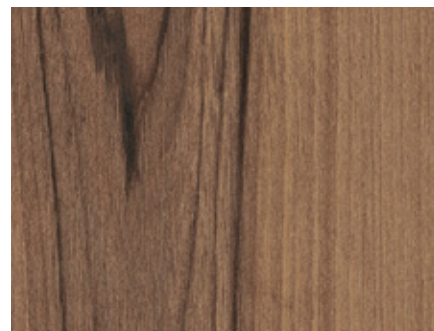

Walnut Tobacco

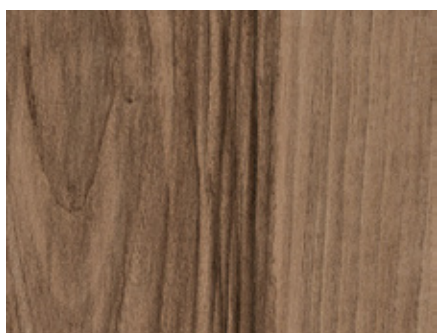

Walnut Cinnamon

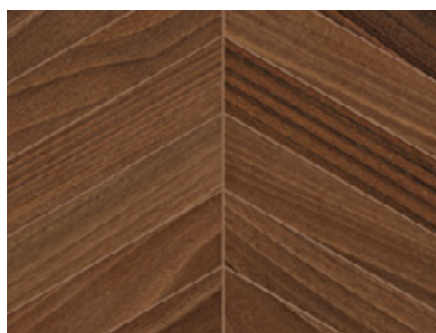

Chevron Walnut Tobacco



Strip Walnut Tobacco



LEA Bio Select | Oak Ginger | 30x180 | Naturale















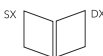

Pod LEA Bio Select | Oak Natural | 30x180 | Naturale
Zid LEA Bio Select | Oak Natural Strip | 20x120 | Naturale



LEA Bio Select | Oak Cloves | 20x120 | Naturale

LEA BIO SELECT

								
		20x120	30x120	30x180	30x120	Chevron 42,8x40	Strip 20x120	Dekor
		9,5	9,5	10,5	20	9,5	9,5	Format (cm)
		Naturale	Naturale	Naturale	Grip	Naturale	Naturale	Debljina (mm)
		R10 (W.R9)	R10 (W.R9)	R10 (W.R9)	R11 C	R10	R10	Završna obrada
								Protukliznost
	Oak Vanilla	51,43	51,43	60,74		175,71	143,75	MPC (€/m ²)
		387,53	387,53	457,65		1.323,89	1.083,09	MPC (Kn/m ²)
		603624	603624	603613		603594	603603	Šif. / Dostupnost
	Oak Ginger	51,43	51,43	60,74		175,71	143,75	MPC (€/m ²)
		387,53	387,53	457,65		1.323,89	1.083,09	MPC (Kn/m ²)
		603621	603620	603611		603592	603601	Šif. / Dostupnost
	Oak Natural	51,43	51,43	60,74	86,95	175,71	143,75	MPC (€/m ²)
		387,53	387,53	457,65	655,11	1.323,89	1.083,09	MPC (Kn/m ²)
		603623	603622	603612	603608	603593	603602	Šif. / Dostupnost
	Oak Ash	51,43	51,43	60,74		175,71	143,75	MPC (€/m ²)
		387,53	387,53	457,65		1.323,89	1.083,09	MPC (Kn/m ²)
		603617	603628	603609		603590	603599	Šif. / Dostupnost
	Oak Cloves	51,43	51,43	60,74	86,95	175,71	143,75	MPC (€/m ²)
		387,53	387,53	457,65	655,11	1.323,89	1.083,09	MPC (Kn/m ²)
		603619	603618	603610	603607	603591	603600	Šif. / Dostupnost
	Walnut Tobacco	51,43	51,43	60,74		175,71	143,75	MPC (€/m ²)
		387,53	387,53	457,65		1.323,89	1.083,09	MPC (Kn/m ²)
		603628	603627	603615		603596	603605	Šif. / Dostupnost
	Walnut Cinnamon	51,43	51,43	60,74		175,71		MPC (€/m ²)
		387,53	387,53	457,65		1.323,89		MPC (Kn/m ²)
		603626	603625	603614		603595		Šif. / Dostupnost

PRISSMACER **MIRO**





Nubole



Fumo



Terra



Fuoco







Natura

Miro je kolekcija koja nudi pet lijepih tonova smeđe boje.

Vjerna imitacija drveta ponovno spaja čovjeka s prirodnom te njegovo životno okruženje čini ugodnim, lijepim mjestom.



PRISMACER
MIRO

		20x120	Format (cm)
		9	Debljina (mm)
		Naturale	Završna obrada
		R11	Protukliznost
	Nubole	23,00	MPC (€/m ²)
		173,28	MPC (Kn/m ²)
		597365/Ⓞ	Šif. / Dostupnost
	Fumo	34,80	MPC (€/m ²)
		262,20	MPC (Kn/m ²)
		606059	Šif. / Dostupnost
	Terra	34,80	MPC (€/m ²)
		262,20	MPC (Kn/m ²)
		606058	Šif. / Dostupnost
	Fuoco	23,00	MPC (€/m ²)
		173,28	MPC (Kn/m ²)
		597366/Ⓞ	Šif. / Dostupnost
	Natura	34,80	MPC (€/m ²)
		262,20	MPC (Kn/m ²)
		606060	Šif. / Dostupnost

PRISSMACER **OUTI**





Gris



Arce



Roble



Natural



Moka









Outi kolekcija naglašava svaku nijansu plemenitog drveta. Čvorovi i skladne žile drveta uspješno su prenesene na pločice.

Dostupne u dvije dimenzije, svestrano se prilagođavaju različitim stilovima uređenja stambenih, poslovnih i vanjskih prostora.

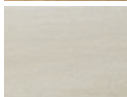

PRISSMACER Outi | Roble | 25x100 | Naturale

PRISSMACER OUTI

				
		25x100	30,5x121	Format (cm)
		8,6	20	Debljina (mm)
		Naturale	Naturale	Završna obrada
		R11	R11	Protukliznost
	Gris	31,77	73,72	MPC (€/m ²)
		239,40	555,41	MPC (Kn/m ²)
		583141	983102	Šif. / Dostupnost
	Arce	20,58	73,72	MPC (€/m ²)
		155,04	555,41	MPC (Kn/m ²)
		583142/Ⓛ	983103	Šif. / Dostupnost
	Roble	20,58	73,72	MPC (€/m ²)
		155,04	555,41	MPC (Kn/m ²)
		583143/Ⓛ	983104	Šif. / Dostupnost
	Natural	31,77	73,72	MPC (€/m ²)
		239,40	555,41	MPC (Kn/m ²)
		583144	983105	Šif. / Dostupnost
	Moka	31,77	73,72	MPC (€/m ²)
		239,40	555,41	MPC (Kn/m ²)
		583145	983106	Šif. / Dostupnost



PRISSMACER Outi | Roble | 25x100 | Naturale

VIDREPUR



VIDREPUR | Niebla Turquesa | 31,5x39,6 | Gloss

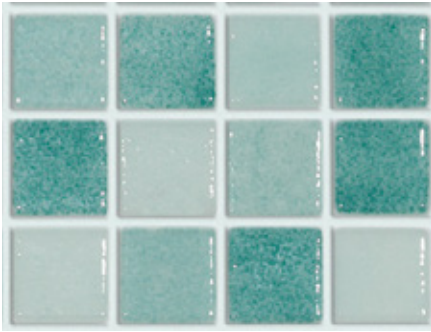

Mezcla Mix

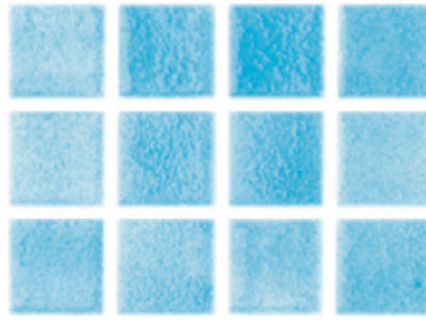

Niebla Turquesa



Niebla Gris Claro



Niebla Blanco

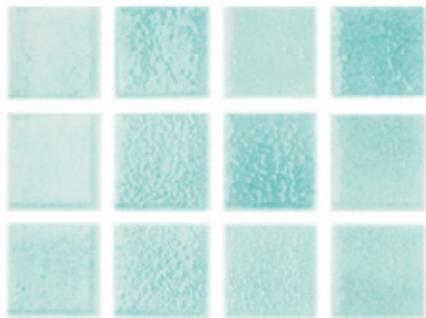

Niebla Verde Caribe



VIDREPUR | Niebla Verde Caribe | 31,5x39,6 | Gloss



VIDREPUR

31,5x39,6 (2,5x2,5)

Format (cm)

Debljina (mm)

Gloss

Završna obrada

Protukliznost



Mezcla Mix

23,52

MPC (€/m²)

177,20

MPC (Kn/m²)

1035083/Ⓛ

Šif. / Dostupnost



Niebla Gris Claro

23,52

MPC (€/m²)

177,20

MPC (Kn/m²)

578398/Ⓛ

Šif. / Dostupnost



Niebla Turquesa

23,52

MPC (€/m²)

177,20

MPC (Kn/m²)

478437/Ⓛ

Šif. / Dostupnost



Niebla Blanco

23,52

MPC (€/m²)

177,20

MPC (Kn/m²)

1035084/Ⓛ

Šif. / Dostupnost



Niebla Verde Caribe

23,52

MPC (€/m²)

177,20

MPC (Kn/m²)

596817/Ⓛ

Šif. / Dostupnost

Vidrepur donosi niz kreativnih ideja za uređenje vašeg prostora. Na našem lageru možete pronaći kvalitetan mozaik ove španjolske tvrtke te se poigrati bojama. Uz malo kreativnosti možete dobiti unikatan zid, bazen, pod ili čitavu prostoriju.

Uz Vidrepur možete dobiti različite efekte i oblike mosaica čime će se upotpuniti dojam. U ponudi Vidrepura možete pronaći zanimljive trodimenzionalne uzorke, sjajne, matirane, sa sedefastim sjajem, šljokicama, s efektom stakla, kamena, mramora, drveta te još mnoštvo drugih dizajna.

RASPOLOŽIVE BOJE I ZAVRŠNE OBRADJE

● Bijela sjajna

○ Crna mat

● Srebrno-bijela

● Bijela mat

● Zlatno-crna

● Cement mat

● Zlatno-bijela

A dark, monochromatic background filled with numerous water droplets of varying sizes. The droplets are out of focus, creating a bokeh effect with soft, glowing highlights. The overall mood is clean and fresh.

SANITARIJE

CATALANO



HORIZON



CATALANO Horizon | umivaonik | bijeli sjajni | 70x35 cm | 
 CATALANO | keramički top | bijeli sjajni | 125x50 cm



Catalano Horizon 60 |
 Satin cement | 60x35 cm |
 847454 | 312,28 €
 | 2.352,90 kn

Cijena za boje
 i  744,70 €
 | 5.610,94 kn

Ovalni i okrugli umivaonici s ravnim površinama karakteriziraju kolekciju Horizon. Uz lijepu kolekciju Horizon dolaze i topovi za umivaonike.

















Ova kolekcija prikladna je za svaki tip uređenja kupaonice jer je ujedno i elegantna i klasična.



CATALANO Horizon | umivaonik | bijeli sjajni | 120x50 cm

CATALANO HORIZON



	Ø 50 		50x35 		60x35 	Dimenzije (cm) Boja Dostupnost Šifra artikla MPC (€) MPC (Kn)
	866600 235,26 1.772,56		847458 156,56 1.179,60		847452 165,99 1.250,63	
Horizon 50 Nadgradni umivaonik bez preljeva, bijeli sjajni.	Horizon 50 Nadgradni umivaonik bez preljeva, bijeli sjajni.	Horizon 60 Nadgradni umivaonik bez preljeva, bijeli sjajni.				
	70x35 		75x50 		100x50 	Dimenzije (cm) Boja Dostupnost Šifra artikla MPC (€) MPC (Kn)
	847446 175,99 1.325,96		866602 332,41 2.504,53		866576 430,24 3.241,68	
Horizon 70 Nadgradni umivaonik bez preljeva, bijeli sjajni.	Horizon 75 Umivaonik s mogućnošću montaže na zid, nadgradno na Catalano metalnu strukturu ili Catalano kupaonski ormarić, bijeli sjajni.	Horizon 100 Umivaonik s mogućnošću montaže na zid, nadgradno na Catalano metalnu strukturu ili Catalano kupaonski ormarić, bijeli sjajni.				
	125x50 		51 	Dimenzije (cm) Boja Dostupnost Šifra artikla MPC (€) MPC (Kn)		
	866588 546,83 4.120,08		866632 114,20 860,44			
Horizon 125 Umivaonik s mogućnošću montaže na zid, nadgradno na Catalano metalnu strukturu ili Catalano kupaonski ormarić, bijeli sjajni.	Držać ručnika Aluminijski držać ručnika za umivaonik Horizon 75, krom. Držać ručnika dostupan je i u ostalim dimenzijama.					

CATALANO

GREEN LUX

Green Lux je kolekcija koja nudi umivaonike nježne površine i glatkih, tankih završetaka.

Ova kolekcija zadržava klasičan dizajn, ali uz dozu profinjenosti. Jednostavna je za kombiniranje s bilo kojom vrstom uređenja vaše kupaonice, a naročito one koja naginje modernom i suvremenom stilu.



CATALANO Green Lux | umivaonik | bijeli sjajni | 60x40 | 

CATALANO | keramički top | bijeli sjajni | 125x50 cm



Catalano Green Lux 60
| Satin black | 60x40 cm
| 584479 | 477,43 €
| 3.597,19 kn



Catalano Sfera
Newflush wc školjka
| Satin black | 54x35
| 584116 | 510,05 €
| 3.842,96 kn



Wc sjedalo Soft-close
| TakeOff | Satin black
| 584117 | 167,93 €
| 1.265,23 kn

CATALANO GREEN LUX



	40x40		40x40		50x38	Dimenzije (cm)
	○ ○ ○ ●		○ ○ ○ ●		○ ○ ○ ●	Boja
	Ⓛ		Ⓛ		Ⓛ	Dostupnost
	449432		584453		493500	Šifra artikla
169,70 1.278,60	169,70 1.278,60	176,55 1.330,22	MPC (€) MPC (Kn)			
Green Lux 40		Green Lux 40		Green Lux 50		
Nadgradni ili polunadgradni umivaonik bez preljeva, bijeli sjajni.		Nadgradni umivaonik bez preljeva, bijeli sjajni.		Nadgradni ili polunadgradni umivaonik bez preljeva, bijeli sjajni.		

	60x38		60x40		65x40	Dimenzije (cm)
	○ ○ ○ ●		○ ○ ○ ●		○ ○ ○ ●	Boja
	Ⓛ		Ⓛ		Ⓛ	Dostupnost
	449431		584113		449430	Šifra artikla
184,66 1.391,31	184,66 1.391,31	191,51 1.442,93	MPC (€) MPC (Kn)			
Green Lux 60		Green Lux 60		Green Lux 65		
Nadgradni ili polunadgradni umivaonik bez preljeva, bijeli sjajni.		Nadgradni umivaonik bez preljeva, bijeli sjajni.		Nadgradni ili polunadgradni umivaonik bez preljeva, bijeli sjajni.		

	75x40		80x40		55x38	Dimenzije (cm)
	○ ○ ○ ●		○ ○ ○ ●		○ ○ ○ ●	Boja
	Ⓛ		Ⓛ			Dostupnost
	498673		583154		584454	Šifra artikla
201,34 1.517,01	201,34 1.517,01	1.171,37 8.825,68	MPC (€) MPC (Kn)			
Green Lux 75		Green Lux 80		Green Lux 55		
Nadgradni ili polunadgradni umivaonik bez preljeva, bijeli sjajni.		Nadgradni umivaonik bez preljeva, bijeli sjajni.		Samostojeći umivaonik bez preljeva s odvodom u zid, bijeli sjajni.		

	55x38	Dimenzije (cm)
	○ ○ ○ ●	Boja
		Dostupnost
	584114	Šifra artikla
1.171,37 8.825,68	MPC (€) MPC (Kn)	
Green Lux 55		
Samostojeći umivaonik bez preljeva s odvodom u pod, bijeli sjajni.		

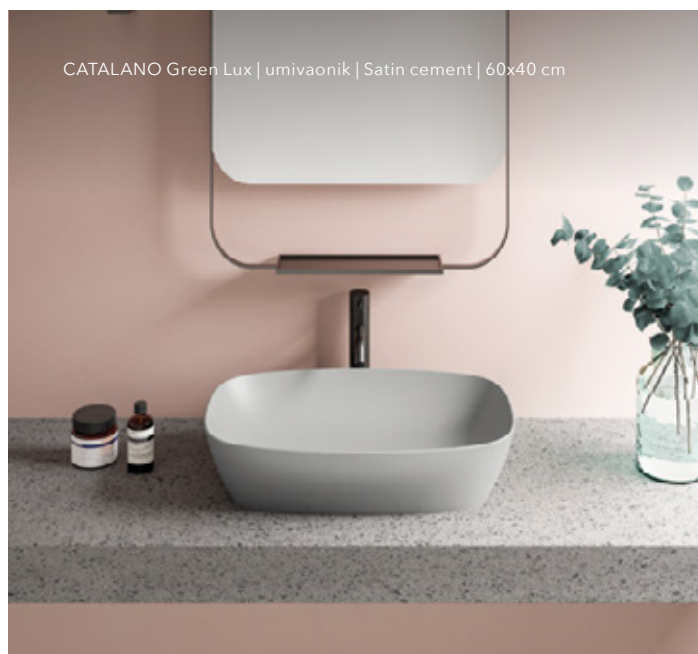

CATALANO GREEN



Catalano Green Lux 60 |
Satin cement | 60x40 cm
| 584459 | 477,43 €
| 3.597,19 kn

Green kolekcija nudi umivaonike klasičnog izgleda s kojima se ne može pogriješiti.

Odličan su izbor za svakoga tko voli jednostavnost i minimalizam u svojoj kupaonici.

CATALANO GREEN



	42x42		60x40		65x42	Dimenzije (cm)
	○○●●		○○●●		○○●●	Boja
584452	584451	584450	Dostupnost			
275,50 2.075,80	299,79 2.258,74	310,88 2.342,33	Šifra artikla			
Green Lux 42	Green Lux 60	Green Lux 65	MPC (€) MPC (Kn)			
Nadgradni ili polunadgradni umivaonik bez preljeva, bijeli sjajni.	Nadgradni ili polunadgradni umivaonik bez preljeva, bijeli sjajni.	Nadgradni ili polunadgradni umivaonik bez preljeva, bijeli sjajni.				

	60x50		80x50		100x50	Dimenzije (cm)
	○		○		○	Boja
449421	449420	449419	Dostupnost			
258,13 1.944,93	328,22 2.473,00	430,24 3.241,68	Šifra artikla			
Green 60	Green 80	Green 100	MPC (€) MPC (Kn)			
Umivaonik s mogućnošću montaže na zid ili nadgradno, bijeli sjajni.	Umivaonik s mogućnošću montaže na zid ili nadgradno, bijeli sjajni.	Umivaonik s mogućnošću montaže na zid ili nadgradno, bijeli sjajni.				

	54	Dimenzije (cm)
	○	Boja
827121	Dostupnost	
112,61 848,48	Šifra artikla	
Držac ručnika	MPC (€) MPC (Kn)	
Držac ručnika za umivaonik Green 60, krom. Držači ručnika dostupni su i u ostalim dimenzijama.		



CATALANO Green Lux | umivaonik | Satin cement | 42x42 cm



CATALANO Green Lux | umivaonik | Satin black | 60x40 cm

CATALANO

NEW PREMIUM









New Premium kolekcija donosi umivaonike isključivo četvrtastog oblika. Radi se o suvremenom dizajnu koji daje svestrane mogućnosti.

Kolekcija New Premium nudi lepezu dimenzija umivaonika, pa će se tako pronaći odgovarajući umivaonik za svaku dimenziju vaše kupaonice.



CATALANO NEW PREMIUM



	50x47		55x35		60x47	Dimenzije (cm)
	○		○		○	Boja
	Ⓛ		Ⓛ		Ⓛ	Dostupnost
	986005		853875		986006	Šifra artikla
182,68 1.376,39	243,71 1.836,20	195,35 1.471,90	MPC (€) MPC (Kn)			
New Premium 50	New Premium 55	New Premium 60				
Umivaonik s mogućnošću montaže na zid ili nadgradno, bijeli sjajni.	Umivaonik s mogućnošću montaže na zid ili nadgradno, bijeli sjajni.	Umivaonik s mogućnošću montaže na zid ili nadgradno, bijeli sjajni.				
	80x47		80x47		100x47	Dimenzije (cm)
	○		○		○	Boja
	Ⓛ		Ⓛ		Ⓛ	Dostupnost
	986007		991170		986008	Šifra artikla
240,74 1.813,89	462,18 3.482,28	448,56 3.379,70	MPC (€) MPC (Kn)			
New Premium 80	New Premium 80	New Premium 100				
Umivaonik s mogućnošću montaže na zid ili nadgradno, bijeli sjajni.	Umivaonik s mogućnošću montaže na zid ili nadgradno, bijeli sjajni. Model umivaonka može biti lijevi ili desni.	Umivaonik s mogućnošću montaže na zid ili nadgradno, bijeli sjajni.				
	100x47		120x47		45	Dimenzije (cm)
	○		○		○	Boja
	991169		991168		578776	Dostupnost
	584,98 4.407,55		799,43 6.023,30		130,06 979,95	Šifra artikla
MPC (€) MPC (Kn)						
New Premium 100	New Premium 120	Držać ručnika				
Umivaonik s mogućnošću montaže na zid ili nadgradno, bijeli sjajni.	Umivaonik s mogućnošću montaže na zid ili nadgradno, bijeli sjajni.	Držać ručnika za umivaonik New Premium 50, krom. Držači ručnika dostupni su i u ostalim dimenzijama.				

CATALANO New Premium | umivaonik | bijeli sjajni | 60x47 cm | Ⓛ



CATALANO

ZERO

Vrlo opširna kolekcija Zero nudi sve što možete zamisliti od umivaonika. Trebate li mali ili veliki umivaonik, s kupaonskim ormarićem ili bez, sve možete vidjeti u kolekciji Zero.

Riječ kojom su se vodili prilikom osmišljavanja ove kolekcije je svestranost.











CATALANO Zero | umivaonik | bijeli sjajni | 100x50 cm



CATALANO Zero | umivaonik | bijeli sjajni | 100x50 cm
 CATALANO | metalna struktura | inox | 95x47 cm

CATALANO ZERO



	Ø 45		50x25		50x50	Dimenzije (cm)
	○		○ ○ ● ●		○	Boja
	Ⓛ		Ⓛ		Ⓛ	Dostupnost
	603340		486372		578775	Šifra artikla
Zero 45	191,53 1.443,10	Zero 50	184,86 1.392,83	Zero 50	222,71 1.678,00	MPC (€) MPC (Kn)
Nadgradni umivaonik bez preljeva, bijeli sjajni.		Umivaonik s mogućnošću montaže na zid ili nadgradno, bijeli sjajni.		Umivaonik s mogućnošću montaže na zid ili nadgradno, bijeli sjajni.		
	60x50		75x50		75x50	Dimenzije (cm)
	○		○		○	Boja
	Ⓛ		Ⓛ		Ⓛ	Dostupnost
	578773		578771		578786	Šifra artikla
Zero 60	238,09 1.793,87	Zero 75	294,94 2.222,24	Zero 75	507,96 3.827,21	MPC (€) MPC (Kn)
Umivaonik s mogućnošću montaže na zid ili nadgradno, bijeli sjajni.		Umivaonik s mogućnošću montaže na zid, nadgradno na Catalano metalnu strukturu ili Catalano kupaonski ormarić, bijeli sjajni.		Umivaonik s mogućnošću montaže na zid, nadgradno na Catalano metalnu strukturu ili Catalano kupaonski ormarić, bijeli sjajni. Model umivaonika može biti lijevi ili desni.		
	100x50		100x50		45	Dimenzije (cm)
	○		○		○	Boja
	Ⓛ		Ⓛ		Ⓛ	Dostupnost
	578769		578784		578776	Šifra artikla
Zero 100	492,41 3.710,06	Zero 100	648,13 4.883,36	Držać ručnika	130,06 979,95	MPC (€) MPC (Kn)
Umivaonik s mogućnošću montaže na zid, nadgradno na Catalano metalnu strukturu ili Catalano kupaonski ormarić, bijeli sjajni.		Umivaonik s mogućnošću montaže na zid, nadgradno na Catalano metalnu strukturu ili Catalano kupaonski ormarić, bijeli sjajni. Model umivaonika može biti lijevi ili desni.		Držać ručnika za umivaonik Zero 50, krom. Držači ručnika dostupni su i u ostalim dimenzijama.		

CATALANO

GOLD&SILVER



Catalano Classy
 Newflush wc školjka |
 Silver-White | 55x35 cm |
 827074 | 892,21 €
 | 6.722,35 kn

Wc sjedalo Soft-close
 | TakeOff | bijelo | 248769
 | 114,36 € | 861,68 kn | (L)

Za one vrlo profinjenog i istančanog ukusa, tu je Gold&Silver varijanta sanitarija. Bogata zlatna i raskošna srebrna u kombinaciji s bijelom, postižu poseban dojam kupaonice.

Volite li luksuzna uređenja, sanitarije u zlatnoj ili srebrnoj boji idealan su izbor za vas.

CATALANO GOLD&SILVER



	40x40		60x40		80x40	Dimenzije (cm)
						Boja
	578643		578640		578637	Dostupnost
	743,11 5.598,96		824,00 6.208,44		869,20 6.548,99	Šifra artikla
Green Lux 40		Green Lux 60		Green Lux 80		MPC (€) MPC (Kn)
Nadgradni umivaonik bez preljeva, crno zlatni.		Nadgradni umivaonik bez preljeva, crno zlatni.		Nadgradni umivaonik bez preljeva, crno zlatni.		

	Ø 42		60x42		70x42	Dimenzije (cm)
						Boja
	578633		578630		578627	Dostupnost
	743,11 5.598,96		824,00 6.208,44		869,20 6.548,99	Šifra artikla
Velis 42		Velis 60		Velis 70		MPC (€) MPC (Kn)
Nadgradni umivaonik, bijelo zlatni.		Nadgradni umivaonik, bijelo zlatni.		Nadgradni umivaonik, bijelo zlatni.		

	50x35		60x35		70x35	Dimenzije (cm)
						Boja
	847463		847457		847451	Dostupnost
	723,28 5.449,54		744,70 5.610,94		767,71 5.784,30	Šifra artikla
Horizon 50		Horizon 60		Horizon 70		MPC (€) MPC (Kn)
Nadgradni umivaonik bez preljeva, bijelo srebrni.		Nadgradni umivaonik bez preljeva, bijelo srebrni.		Nadgradni umivaonik bez preljeva, bijelo srebrni.		

	Ø 40	Dimenzije (cm)
		Boja
		Dostupnost
	866595	Šifra artikla
Classy 40	743,11 5.598,96	MPC (€) MPC (Kn)
Nadgradni umivaonik bez preljeva, bijelo srebrni.		

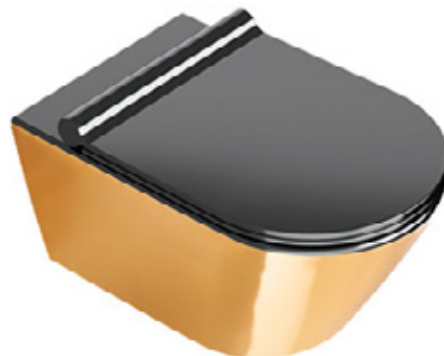

Catalano Zero
Newflush wc školjka |
Gold-Black | 55x35 cm |
578622 | 992,93 €
| 7.481,25 kn

Wc sjedalo Soft-close
| TakeOff | Satin black |
391751 | 167,92 €
| 1.265,23 kn

CATALANO

CANOVA ROYAL

Kolekcija Canova Royal osmišljena je za kupaonice vintage stila. Svojim dizajnom već na prvi pogled se razlikuju od ostalih kolekcija iz Catalana. Podsjećaju na kupaonice kakve su nekada postojale, a danas su ih zamijenile one modernog izgleda.

Za one koji su željeli vintage dizajn uklopiti u svoje kupaonice, Canova Royal nudi sve što je potrebno od sanitarija.



CATALANO Canova Royal | umivaonik | bijeli sjajni | 105x54 cm
CATALANO Canova Royal | keramička noga | bijela sjajna

CATALANO CANOVA ROYAL



	60x46		75x50		90x50	Dimenzije (cm)
	○		○		○	Boja
	359256		359826		280388	Dostupnost
	213,73 1.610,36		328,22 2.473,00		393,47 2.964,58	Šifra artikla
Canova Royal 60		Canova Royal 75		Canova Royal 90		MPC (€) MPC (Kn)
Umivaonik s mogućnošću montaže na zid ili na keramičku nogu, bijeli sjajni.		Umivaonik s mogućnošću montaže na zid ili na keramičku nogu, bijeli sjajni.		Umivaonik s mogućnošću montaže na zid ili na keramičku nogu, bijeli sjajni.		

	105x54		56x44		70x52	Dimenzije (cm)
	○		○		○	Boja
	391739		312421		242942	Dostupnost
	492,71 3.712,30		239,42 1.803,88		263,70 1.986,83	Šifra artikla
Canova Royal 105		Canova Royal 56		Canova Royal 70		MPC (€) MPC (Kn)
Umivaonik s mogućnošću montaže na zid ili na keramičku nogu, bijeli sjajni.		Umivaonik s mogućnošću montaže na zid ili na keramičku nogu, bijeli sjajni.		Umivaonik s mogućnošću montaže na zid ili na keramičku nogu, bijeli sjajni.		

	60x40		51		66x30	Dimenzije (cm)
	○		○		○	Boja
	391740		360152		248739	Dostupnost
	312,28 2.352,90		154,66 1.165,28		156,14 1.176,45	Šifra artikla
Canova Royal 60		Držać ručnika		Keramička noga		MPC (€) MPC (Kn)
Nadgradni ili polunadgradni umivaonik, bijeli sjajni.		Držać ručnika za umivaonik Canova Royal 60, krom. Držać ručnika dostupan je i u ostalim dimenzijama.		Keramička noga za umivaonik, bijela sjajna. Za sve modele umivaonika.		



Catalano Canova Royal 55
wc školjka | bijela sjajna
| 55x36 cm | 430930
| 338,66 € | 2.551,60 kn

Wc sjedalo | bijelo | 248764
| 88,84 € | 669,33 kn



Catalano Canova Royal 53
wc školjka | bijela sjajna
| 53x36 cm | 236559
| 246,35 € | 1.856,15 kn

Wc sjedalo | bijelo | 248764
| 88,84 € | 669,33 kn

CATALANO NAMJEŠTAJ

Catalano, osim lijepih sanitarija, nudi i namještaj koji je savršeno kompatibilan s vašim izborom umivaonika, wc školjke ili bidea. U ponudi su keramički topovi, metalne strukture te kupaonski ormarići.

Izborom namještaja znatno je olakšana potraga za savršenom kombinacijom namještaja i sanitarija. U Catalanu pronađite sve na jednom mjestu.



CATALANO Horizon | umivaonik | bijeli sjajni | 60x35 cm | 

CATALANO | keramički top | bijeli sjajni | 100x50 cm

CATALANO | metalna struktura | crna mat | 95x47 cm; aluminijski držač ručnika

CATALANO NAMJEŠTAJ

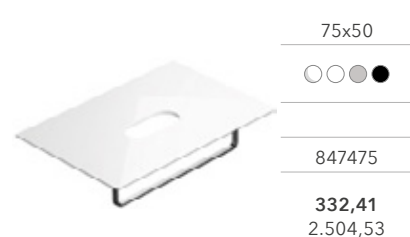
**Top 75**

Keramički top za nadgradni umivaonik, za montažu na Catalano metalnu strukturu ili Catalano kupaonski ormarić, bijeli sjajni. Kompatibilan s nadgradnim umivaonicima iz kolekcije Horizon, Green Lux, Verso i Classy.

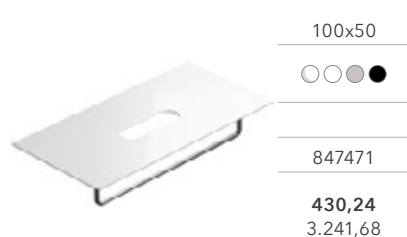
**Top 100**

Keramički top za nadgradni umivaonik, za montažu na Catalano metalnu strukturu ili Catalano kupaonski ormarić, bijeli sjajni. Kompatibilan s nadgradnim umivaonicima iz kolekcije Horizon, Green Lux, Verso i Classy.

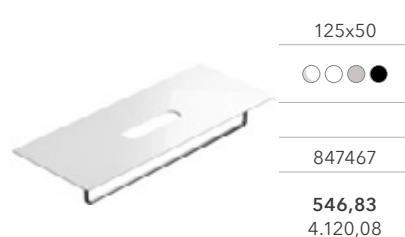
**Top 125**

Keramički top za nadgradni umivaonik, za montažu na Catalano metalnu strukturu ili Catalano kupaonski ormarić, bijeli sjajni. Kompatibilan s nadgradnim umivaonicima iz kolekcije Horizon, Green Lux, Verso i Classy.

Dimenzije (cm)
Boja
Dostupnost
Šifra artikla
MPC (€) MPC (Kn)

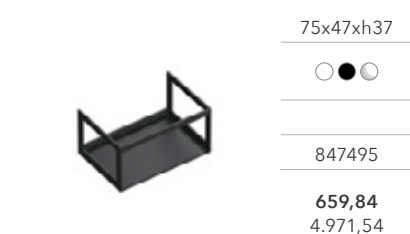
**Metalna struktura 75**

Aluminijska konstrukcija s policom, crna mat. Kompatibilna s keramičkim topom ili umivaonicima iz kolekcije New Zero i Horizon.

**Metalna struktura 100**

Aluminijska konstrukcija s policom, crna mat. Kompatibilna s keramičkim topom ili umivaonicima iz kolekcije New Zero i Horizon.

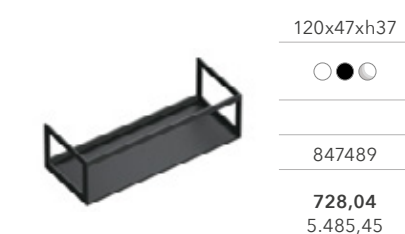
**Metalna struktura 125**

Aluminijska konstrukcija s policom, crna mat. Kompatibilna s keramičkim topom ili umivaonicima iz kolekcije New Zero i Horizon.

Dimenzije (cm)
Boja
Dostupnost
Šifra artikla
MPC (€) MPC (Kn)

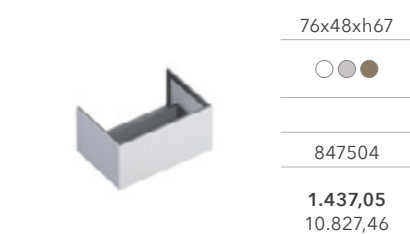
**Kupaonski ormarić 75**

Kupaonski ormarić s jednom ladicom, bijeli mat. Kompatibilan s keramičkim topom ili umivaonicima iz kolekcije New Zero i Horizon.

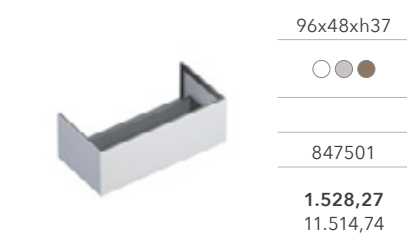
**Kupaonski ormarić 100**

Kupaonski ormarić s jednom ladicom, bijeli mat. Kompatibilan s keramičkim topom ili umivaonicima iz kolekcije New Zero i Horizon.

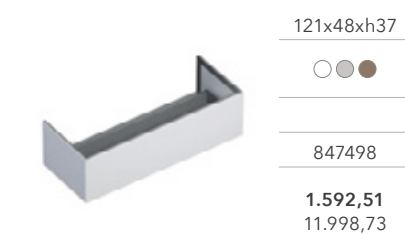
**Kupaonski ormarić 120**

Kupaonski ormarić s jednom ladicom, bijeli mat. Kompatibilan s keramičkim topom ili umivaonicima iz kolekcije New Zero i Horizon.

Dimenzije (cm)
Boja
Dostupnost
Šifra artikla
MPC (€) MPC (Kn)

**Držac ručnika**

Aluminijski držač ručnika za Top 75, krom. Držači ručnika dostupni su i u ostalim dimenzijama.

**Držac ručnika**

Aluminijski držač ručnika za metalnu strukturu, crni.

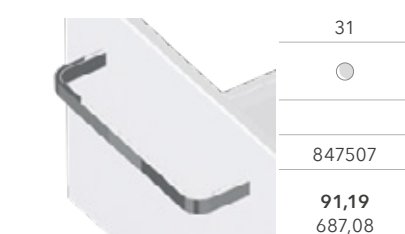
**Držac ručnika**

Aluminijski držač ručnika za kupaonski ormarić, krom.

Dimenzije (cm)
Boja
Dostupnost
Šifra artikla
MPC (€) MPC (Kn)

CATALANO

WC ŠKOLJKE I BIDEI



Catalano wc školjke i bidei univerzalna su rješenja za opremanje kupaone. Odgovarat će bilo kojem odabiru umivaonika ili namještaja Catalano. Jednostavnost i lijep dizajn najveće su prednosti Catalano wc školjki i bidea te će se takve vrlo lijepo uklopiti u bilo koji stil uređenja vaše kupaonice. Njihova dodatna prednost je i izbor prilikom odabira boja. Osim klasične bijele, tu su i divne pastelne boje te zlatna i srebrna koje dolaze u kombinaciji s bijelom i crnom.





































CATALANO Zero | wc školjka Newflush | Satin black | 55x35 cm
 CATALANO | wc sjedalo Soft-close, TakeOff | Satin black
 CATALANO Zero | bide | Satin black | 55x35 cm

CATALANO WC ŠKOLJKE



	54x35		52x37		52x37	Dimenzije (cm)
	○		○○		○○	Boja
	Ⓛ		Ⓛ		Ⓛ	Dostupnost
	498682		830399		859336	Šifra artikla
	167,65 1.263,15		167,65 1.263,15		201,53 1.518,43	MPC (€) MPC (Kn)
Sfera Eco New		Italy 52		Italy 52		
Zidna wc školjka Newflush, bijela sjajna.		Zidna wc školjka Newflush, bijela sjajna.		Podna wc školjka Newflush, bijela sjajna.		

CATALANO WC ŠKOLJKE

	54x35   391737 216,72 1.632,88		54x35   324444 215,41 1.622,97		55x35   391729 262,46 1.977,51	Dimenzije (cm) Boja Dostupnost Šifra artikla MPC (€) MPC (Kn)
Sfera Zidna wc školjka Newflush, bijela sjajna.		Sfera Zidni bide, bijeli sjajni.		Zero Zidna wc školjka Newflush, bijela sjajna.		
	55x35   391731 340,87 2.568,28		39x31   113492 285,90 2.154,12		  360158 61,07 460,13	Dimenzije (cm) Boja Dostupnost Šifra artikla MPC (€) MPC (Kn)
Zero Zidni bide, bijeli sjajni.		Big Boy Pisoar, bijeli sjajni.		Wc sjedalo Wc sjedalo, bijelo.		
	  866623 64,95 489,33		  1062839 64,95 489,33		  211539 94,37 711,02	Dimenzije (cm) Boja Dostupnost Šifra artikla MPC (€) MPC (Kn)
Wc sjedalo Italy Wc sjedalo Italy Soft-close, TakeOff, bijelo.		Wc sjedalo Wc sjedalo Soft-close, TakeOff, bijelo.		Wc sjedalo Wc sjedalo Soft-close, TakeOff, bijelo.		
	  248769 114,36 861,68		 311160 20,93 157,68		  601934 15,23 114,75	Dimenzije (cm) Boja Dostupnost Šifra artikla MPC (€) MPC (Kn)
Wc sjedalo Wc sjedalo Soft-close, TakeOff, bijelo.		Set Set za montažu, donji.		Set Set za montažu podne wc školjke ili bidea.		

IDEAL STANDARD **STRADA**



IDEAL STANDARD Tesi | wc školjka Aquablade | bijela sjajna | 36,5x53,5 cm | 

IDEAL STANDARD | wc sjedalo Soft-close | bijelo | 

IDEAL STANDARD Tesi | bide | 36x53 cm

IDEAL STANDARD STRADA



	50x42		50x42		60x42	Dimenzije (cm)
	○		○		○	Boja
	Ⓛ		Ⓛ		Ⓛ	Dostupnost
	277803		448173		277804	Šifra artikla
	137,35 1.034,89		156,60 1.179,90		158,40 1.193,44	MPC (€) MPC (Kn)
Strada 50		Strada 50 VSL		Strada 60		
Umivaonik s mogućnošću montaže na zid ili nadgradno, bijeli sjajni.		Umivaonik s mogućnošću montaže na zid ili nadgradno, bijeli sjajni. Umivaonik glaziran sa sve četiri strane.		Umivaonik s mogućnošću montaže na zid ili nadgradno, bijeli sjajni.		

	60x42		70x42		36,5x53,5	Dimenzije (cm)
	○		○		○	Boja
	Ⓛ		Ⓛ		Ⓛ	Dostupnost
	277810		277807		449413	Šifra artikla
	160,90 1.212,33		155,67 1.172,93		168,77 1.271,56	MPC (€) MPC (Kn)
Strada 60 VSL		Strada 70		Tesi		
Umivaonik s mogućnošću montaže na zid ili nadgradno, bijeli sjajni. Umivaonik glaziran sa sve četiri strane.		Umivaonik s mogućnošću montaže na zid ili nadgradno, bijeli sjajni.		Zidna wc školjka, bijela sjajna.		

	36,5x53,5		36x53			Dimenzije (cm)
	○		○		○	Boja
	Ⓛ		Ⓛ		Ⓛ	Dostupnost
	449411		449414		449400	Šifra artikla
	208,22 1.568,83		147,23 1.109,33		40,91 308,23	MPC (€) MPC (Kn)
Tesi		Tesi		Wc sjedalo		
Zidna wc školjka Aquablade, bijela sjajna.		Zidni bide, bijeli sjajni.		Wc sjedalo, bijelo.		

		Dimenzije (cm)
	○	Boja
	Ⓛ	Dostupnost
	449401	Šifra artikla
	73,33 552,54	MPC (€) MPC (Kn)
Wc sjedalo		
Wc sjedalo Soft-close, bijelo.		

Strada i Tesi sanitarije postavljaju nove standarde za dizajn te jednostavnost ugradnje i održavanja.

Za savršenu suvremenu kupaonicu, Ideal Standard je odličan izbor.





INDA NAMJEŠTAJ

Širok asortiman Inde nudi jednostavna rješenja za svačiju kupaonicu. Bazni modeli, koje možete prilagođavati prema svojim potrebama i željama, odgovarat će uz jednostavno uređenje kupaonice.

Neovisno o tome želite li kupaonski ormarić s jednom ili više ladica ili vam treba ormarić manjih/većih dimenzija, pobrinuli smo se da za vas budu brzo dostupni.



Inda kupaonski namještaj koji je dostupan na našem lageru ponajviše će obradovati one koji njeguju jednostavnost stila i koji vole funkcionalne stvari.





INDA City | baza za umivaonik | Rovere Castano | 60 cm |  
INDA | ogledalo 60 cm s nadgradnom LED rasvjetom |  

INDA NAMJEŠTAJ



	š60 x v60 x d45		š60 x v60 x d45		š60 x v60 x d45	Dimenzije (cm)
	Ⓛ		Ⓛ		Ⓛ	Dostupnost
	866858		866859		866860	Šifra artikla
355,92 2.681,68	355,92 2.681,68	433,16 3.263,66	MPC (€) MPC (Kn)			
City 60		City 60		City 60		
Baza za umivaonik s 2 ladice, širine 60 cm, Rovere Castano.		Baza za umivaonik s 2 ladice, širine 60 cm, Olmo Fume.		Baza za umivaonik s 2 ladice, širine 60 cm, Bianco Lucido.		



	š60 x v60 x d45		š80 x v30 x d45		š80 x v30 x d45	Dimenzije (cm)
	Ⓛ		Ⓛ		Ⓛ	Dostupnost
	866861		866848		866849	Šifra artikla
393,78 2.966,96	249,90 1.882,88	249,90 1.882,88	MPC (€) MPC (Kn)			
City 60		Village 80		Village 80		
Baza za umivaonik s 2 ladice, širine 60 cm, Avorio Opaco.		Baza za umivaonik s 1 ladicom, širine 80 cm, Rovere Castano.		Baza za umivaonik s 1 ladicom, širine 80 cm, Olmo Fume.		



	š80 x v60 x d45		š80 x v60 x d45		š100 x v30 x d45	Dimenzije (cm)
	Ⓛ		Ⓛ		Ⓛ	Dostupnost
	866852		866853		866850	Šifra artikla
384,70 2.898,50	384,70 2.898,50	263,53 1.985,58	MPC (€) MPC (Kn)			
Village 80		Village 80		Village 100		
Baza za umivaonik s 2 ladice, širine 80 cm, Rovere Castano.		Baza za umivaonik s 2 ladice, širine 80 cm, Olmo Fume.		Baza za umivaonik s 1 ladicom, širine 100 cm, Rovere Castano.		

	š100 x v30 x d45		š100 x v60 x d45		š100 x v60 x d45	Dimenzije (cm)
	Ⓛ		Ⓛ		Ⓛ	Dostupnost
	866851		866854		866855	Šifra artikla
263,53 1.985,58	411,21 3.098,28	411,21 3.098,28	MPC (€) MPC (Kn)			
Village 100		Village 100		Village 100		
Baza za umivaonik s 1 ladicom, širine 100 cm, Olmo Fume.		Baza za umivaonik s 2 ladice, širine 100 cm, Rovere Castano.		Baza za umivaonik s 2 ladice, širine 100 cm, Olmo Fume.		

INDA NAMJEŠTAJ

	š120 x v60 x d45		š120 x v60 x d45		š120 x v60 x d45	Dimenzije (cm)
	Ⓛ		Ⓛ		Ⓛ	Dostupnost
	866856		866857		967239	Šifra artikla
	437,71 3.297,89		437,71 3.297,89		437,71 3.297,89	MPC (€) MPC (Kn)
Village 120		Village 120		Village 120		
Baza za umivaonik s 2 ladice, širine 120 cm, Rovere Castano.		Baza za umivaonik s 2 ladice, širine 120 cm, Olmo Fume.		Baza za dupli umivaonik s 2 ladice, širine 120 cm, Rovere Castano.		

	š120 x v60 x d45		61x46		81x46	Dimenzije (cm)
	Ⓛ		Ⓛ		Ⓛ	Dostupnost
	967240		866862		866863	Šifra artikla
	437,71 3.297,89		88,59 667,48		135,56 1.021,41	MPC (€) MPC (Kn)
Village 120		Kona 60		Kona 80		
Baza za dupli umivaonik s 2 ladice, širine 120 cm, Olmo Fume.		Umivaonik širine 60 cm, bijeli sjajni. Odgovara City kolekciji namještaja.		Umivaonik širine 80 cm, bijeli sjajni. Odgovara Village kolekciji namještaja.		

	101x46		121x46		121x46	Dimenzije (cm)
	Ⓛ		Ⓛ		Ⓛ	Dostupnost
	866864		866865		866866	Šifra artikla
	175,69 1.323,72		269,59 2.031,23		347,55 2.618,65	MPC (€) MPC (Kn)
Kona 100		Kona 120		Kona 120		
Umivaonik širine 100 cm, bijeli sjajni. Odgovara Village kolekciji namještaja.		Umivaonik širine 120 cm, bijeli sjajni. Odgovara Village kolekciji namještaja.		Dupli umivaonik širine 120 cm, bijeli sjajni. Odgovara Village kolekciji namještaja.		

	š60 x v80		š80 x v80		š80 x v80	Dimenzije (cm)
	Ⓛ		Ⓛ		Ⓛ	Dostupnost
	866870		866871		866867	Šifra artikla
	118,14 890,09		123,08 927,31		269,31 2.029,12	MPC (€) MPC (Kn)
Ogledalo 60		Ogledalo 80		Ogledalo 80		
Ogledalo bez rasvjete širine 60 cm. Može se kombinirati s nadgradnom rasvjetom.		Ogledalo bez rasvjete širine 80 cm. Može se kombinirati s nadgradnom rasvjetom.		Ogledalo s LED rasvjetom širine 80 cm.		

INDA NAMJEŠTAJ



š100 x v80



866868

278,40
2.097,59**Ogledalo 100**

Ogledalo s LED rasvetom širine 100 cm.



š120 x v80



866869

286,67
2.159,91**Ogledalo 120**

Ogledalo s LED rasvetom širine 120 cm.



28 cm



866872

61,12
460,49**Nadgradna rasvjeta**

LED rasvjeta za ogledalo 60/80 cm.

Dimenzije (cm)

Dostupnost

Šifra artikla

MPC (€)
MPC (Kn)

INDA



Inda donosi zanimljiva i lijepa rješenja za opremanje vaše kupaonice namještajem. Zahvaljujući profinjenosti i dašku umjetnosti prilikom dizajniranja proizvoda, vaša kupaonica dobit će završnu notu savršenstva.

U širokom izboru boja, materijala, dimenzija, Inda namještaj postaje iskrojen po vašim željama. Želite li kombinaciju keramike i drveta, ili možda izgled staklene površine, top koji je u istoj boji kao i umivaonik, običnu policu ili namještaj koji

nudi apsolutnu funkcionalnost, sve ćete pronaći ovdje. Namještaj koji na površini ima efekte mramora, kamena ili podsjeća na betonsku površinu – i to je moguće. Bilo da se radi o konvencionalnim oblicima, ili apstraktnim slaganjem elemenata, zaista podiže svaku kupaonicu na novu razinu elegancije.



INDA Indissima

KUPAONSKI NAMJEŠTAJ



INDA Corretto



INDA Prestige



INDA Corretto



INDA Progetto Alu



INDA Qamar

ARCOM



ARCOM e.Ly



ARCOM Dafne

Arcom kroz svoj dizajnerski namještaj nudi sofisticiran i moderan proizvod koji prednjači svojom kvalitetom te inovativnom tehnologijom. Obogaćeni poznavanjem trendova u cijelom svijetu, Arcom uvijek prati posljednje stilove te stvara novo i drugačije postavljajući vlastiti standard.

Kombinacije materijala i boja gotovo su beskonačne jer Arcom zaista ne ostavlja prostor neostvarenim željama. Staklo, drvo, laminam, mramor te drugi kompozitni materijali. Namještaj će postati vrlo bitan dio estetike vaše kupaonice te će stvoriti potpuno drugačiju, posebnu atmosferu.



ARCOM Opera

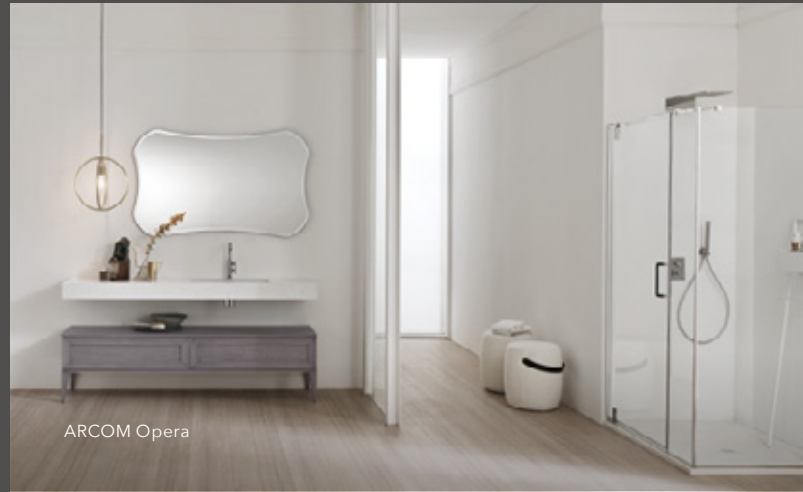

ARCOM Opera



ARCOM Pollock



ARCOM Pollock



ARCOM Shape

VANITA&CASA

Ogledala mogu obogatiti prostor na mnogo različitih načina. Osim svoje prvotne svrhe, služe i kao dekoracija te vizualno povećavaju prostor. Nezaobilazan detalj svačijeg doma uistinu uljepša svaki kutak. Kada se tome pridodaju vrhunski dizajn i kvaliteta, zadovoljstvo je zagarantirano.

Ogledala se ne koriste samo u kupaonicama već gotovo u svim prostorijama zbog toga što postižu lijep ambijent i atmosferu. S rasvjetom ili bez, pravilnih ili nepravilnih oblika, okrugli ili četvrtasti, mogućnosti pri odabiru zaista su velike.



VANITA&CASA



80Hx60
●
858550
223,02 1.680,36

Gamma Black Rectangular

Ogledalo s crnim aluminijskim okvirom. Raspoloživo u dimenzijama 80x40, 80x60, 65x100, 65x120, 65x140, 65x160, 65x180.



Ø 60
●
868298
220,80 1.663,64

Gamma Black Round

Ogledalo s crnim aluminijskim okvirom. Raspoloživo u dimenzijama Ø 60, Ø 90, Ø 100, Ø 120.



90Hx38	Dimenzije (cm)
● ○ ●	Boja
848201	Dostupnost
231,90 1.747,24	Šifra artikla
	MPC (€) MPC (Kn)

Perseo Oval

Ogledalo s crnim aluminijskim okvirom. Raspoloživo u crnoj, bijeloj i zlatnoj boji.



90Hx60
● ○
Ⓛ
832001
195,28 1.471,36

Atlante

Ogledalo s crnim metalnim okvirom i crnim kožnim remenom. Raspoloživo u dimenzijama 90x60, 135x90, u crnoj i bijeloj boji.



135Hx90
● ○
Ⓛ
832002
292,92 2.207,04

Atlante

Ogledalo s crnim metalnim okvirom i crnim kožnim remenom. Raspoloživo u dimenzijama 90x60, 135x90, u crnoj i bijeloj boji.



80Hx45	Dimenzije (cm)
853235	Boja
238,56 1.797,40	Dostupnost
	Šifra artikla
	MPC (€) MPC (Kn)

Pluto

Ogledalo s izravnim svjetlom, mehaničkim prekidačem za uključivanje i isključivanje, LED rasvjetom u boji 4000 K, IP44. Raspoloživo u dimenzijama 80x45, 70x80, 70x100, 70x120, 70x140.



Ø 60
847609
349,51 2.633,40

Pluto Round

Ogledalo s izravnim svjetlom, infracrvenim senzorom za uključivanje i isključivanje, funkcijom odmagljivanja, LED rasvjetom u boji 6000 K, IP44.



Ø 60
● ○
832005
340,64 2.566,53

Argo Round

Ogledalo s crnim aluminijskim okvirom, ambijentalnim osvjetljenjem, ON/OFF touch senzorom, LED rasvjetom u boji 4000K, IP44. Raspoloživo u dimenziji Ø 60, Ø 80, Ø 100, Ø 120 u crnoj i bijeloj boji.











90Hx38	Dimenzije (cm)
● ○ ●	Boja
832286	Dostupnost
382,80 2.884,20	Šifra artikla
	MPC (€) MPC (Kn)

Argo Oval Black

Ogledalo s crnim aluminijskim okvirom, ambijentalnim osvjetljenjem, ON/OFF touch senzorom, LED rasvjetom u boji 4000K, IP44.

VANITA&CASA

 <table border="1" data-bbox="433 392 591 654"> <tr><td>90Hx38</td></tr> <tr><td>● ○ ●</td></tr> <tr><td>848200</td></tr> <tr><td>393,89 2.967,80</td></tr> </table> <p>Argo Oval Gold</p> <p>Ogledalo sa zlatnim aluminijским okvirom, ambijentalnim osvjetljenjem, ON/OFF touch senzorom, LED rasvjetom u boji 4000K, IP44.</p>	90Hx38	● ○ ●	848200	393,89 2.967,80	 <table border="1" data-bbox="859 392 1008 654"> <tr><td>Ø 60</td></tr> <tr><td>832004</td></tr> <tr><td>439,94 3.314,74</td></tr> </table> <p>Eclisse</p> <p>Ogledalo s ambijentalnim osvjetljenjem te izravnim svjetlom, ON/OFF touch senzorom, funkcijom odmagljivanja, LED rasvjetom u boji 4000K ili 6000K, IP44. Raspoloživo u dimenziji Ø 60, Ø 80, Ø 100, Ø 120.</p>	Ø 60	832004	439,94 3.314,74	 <table border="1" data-bbox="1283 392 1634 654"> <tr><td>60Hx60</td></tr> <tr><td>889396</td></tr> <tr><td>438,28 3.302,20</td></tr> </table> <p>Starlight</p> <p>Ogledalo s ambijentalnim osvjetljenjem i izravnim svjetlom, ON/OFF touch senzorom, funkcijom odmagljivanja (nije dostupno na ogledalu 60x60), DualWhite rasvjetom u boji 4000K ili 6000K, IP44. Raspoloživo u dimenzijama 60x60, 80x40, 60x80, 60x100, 70x100, 60x120, 65x140, 65x160, 65x180.</p>	60Hx60	889396	438,28 3.302,20		
90Hx38														
● ○ ●														
848200														
393,89 2.967,80														
Ø 60														
832004														
439,94 3.314,74														
60Hx60														
889396														
438,28 3.302,20														
 <table border="1" data-bbox="433 963 591 1225"> <tr><td>Ø 60</td></tr> <tr><td>●</td></tr> <tr><td>986210</td></tr> <tr><td>418,31 3.151,73</td></tr> </table> <p>Spectral AI</p> <p>Ogledalo s crnim aluminijским okvirom, ambijentalnim osvjetljenjem, ON/OFF touch senzorom, funkcijom odmagljivanja, DynamicWhite rasvjetom u boji 2700K-6500K s prekidačem za promjenu boje, IP44. Raspoloživo u dimenziji Ø 60, Ø 80, Ø 100, Ø 120.</p>	Ø 60	●	986210	418,31 3.151,73	 <table border="1" data-bbox="859 963 1008 1225"> <tr><td>Ø 60</td></tr> <tr><td>●</td></tr> <tr><td>986212</td></tr> <tr><td>493,76 3.720,20</td></tr> </table> <p>Spectral DL Round</p> <p>Ogledalo s crnim aluminijским okvirom i izravnim svjetlom, ON/OFF touch senzorom, funkcijom odmagljivanja (nije dostupno na Ø 60 ogledalu), DynamicWhite rasvjetom u boji 2700K-6500K s prekidačem za promjenu boje, IP44. Raspoloživo u dimenziji Ø 60, Ø 80.</p>	Ø 60	●	986212	493,76 3.720,20	 <table border="1" data-bbox="1283 963 1634 1225"> <tr><td>80Hx40</td></tr> <tr><td>●</td></tr> <tr><td>853233</td></tr> <tr><td>499,30 3.762,00</td></tr> </table> <p>Pollux</p> <p>Ogledalo crne metalne konstrukcije uključujući policu, s ambijentalnim osvjetljenjem, ON/OFF touch senzorom i LED rasvjetom u boji 4000K, IP44. Raspoloživo u dimenzijama 80x40, 80x60, 80x80.</p>	80Hx40	●	853233	499,30 3.762,00
Ø 60														
●														
986210														
418,31 3.151,73														
Ø 60														
●														
986212														
493,76 3.720,20														
80Hx40														
●														
853233														
499,30 3.762,00														
 <table border="1" data-bbox="433 1547 591 1808"> <tr><td>75Hx60</td></tr> <tr><td>●</td></tr> <tr><td>832006</td></tr> <tr><td>528,15 3.979,36</td></tr> </table> <p>Cassiopea</p> <p>Ogledalo s crnim, metalnim okvirom uključujući policu, s ambijentalnim osvjetljenjem, ON/OFF touch senzorom, LED rasvjetom u boji 3000K, IP44.</p>	75Hx60	●	832006	528,15 3.979,36	 <table border="1" data-bbox="859 1547 1008 1808"> <tr><td>65Hx60</td></tr> <tr><td>992421</td></tr> <tr><td>482,66 3.636,60</td></tr> </table> <p>Astro</p> <p>Ogledalo s izravnim svjetlom s GHOST tehnologijom, infracrvenim ON/OFF touch senzorom, funkcijom odmagljivanja, DynamicWhite rasvjetom u boji 3000-6000K s prekidačem za promjenu boje, IP44. Raspoloživo u dimenzijama 65x60, 65x80, 65x100, 65x120, 65x140, 65x160.</p>	65Hx60	992421	482,66 3.636,60	 <table border="1" data-bbox="1283 1547 1634 1808"> <tr><td>80Hx50</td></tr> <tr><td>●</td></tr> <tr><td>860389</td></tr> <tr><td>525,93 3.962,64</td></tr> </table> <p>Castore</p> <p>Ogledalo s crnim metalnim okvirom uključujući policu, s ambijentalnim osvjetljenjem, ON/OFF touch senzorom, LED rasvjetom u boji 4000K, IP44. Raspoloživo u dimenzijama 80x50, 80x60, 80x80.</p>	80Hx50	●	860389	525,93 3.962,64	
75Hx60														
●														
832006														
528,15 3.979,36														
65Hx60														
992421														
482,66 3.636,60														
80Hx50														
●														
860389														
525,93 3.962,64														



VANITA&CASA Castore

VANITA&CASA

	65Hx60		80Hx60		80Hx60	Dimenzije (cm)
						Boja
						Dostupnost
	986213		859365		860437	Šifra artikla
	554,78 4.180,00		591,40 4.455,88		598,05 4.506,04	MPC (€) MPC (Kn)
Oceano		Fenice Black		Fenice Gold		
Ogledalo s izravnim svjetlom s GHOST tehnologijom, ON/OFF touch senzorom, funkcijom odmagljivanja, DualWhite rasvjetom u boji 4000K ili 6000K s opcijom prigušivanja svjetla i promjene boje, IP44. Raspoloživo u dimenzijama 65x60, 65x80, 65x100, 65x120, 65x140, 65x160.		Ogledalo s crnim aluminijskim okvirom uključujući policu, izravnim svjetlom s GHOST tehnologijom, ON/OFF touch senzorom, funkcijom odmagljivanja, LED rasvjetom u boji 4000K ili 6000K, IP44. Raspoloživo u dimenzijama 80x40, 80x60, 80x80, 80x100, 80x120, 80x140.		Ogledalo sa zlatnim aluminijskim okvirom uključujući policu, ON/OFF touch senzorom, funkcijom odmagljivanja, LED rasvjetom na tri strane u boji 4000K ili 6000K, IP44. Raspoloživo u dimenzijama 80x40, 80x60, 80x80, 80x100, 80x120, 80x140.		
	70Hx45		60Hx75		65Hx80	Dimenzije (cm)
						Boja
						Dostupnost
	992422		847608		853234	Šifra artikla
	568,10 4.280,32		609,15 4.589,64		620,25 4.673,24	MPC (€) MPC (Kn)
Avior		Moonshine		Moonlight		
Ogledalo s crnim aluminijskim okvirom s izravnim svjetlom, s GHOST tehnologijom, infracrvenim ON/OFF touch senzorom s prekidačem za promjenu boje, funkcijom odmagljivanja, DynamicWhite rasvjetom u boji 3000-6000K, IP44. Raspoloživo u dimenzijama 70x45, 70x60, 70x80, 70x100, 70x120, 70x140.		Ogledalo s ambijentalnim osvjetljenjem te izravnim svjetlom, ON/OFF touch senzorom, funkcijom odmagljivanja, LED rasvjetom u boji 3000K-4000K ili 6000K s opcijom prigušivanja svjetla te namjenskim prekidačem za uključivanje i isključivanje senzora dodira, IP44. Raspoloživo u dimenzijama 65x75, 60x90, 65x120, 65x150.		Ogledalo s ambijentalnim osvjetljenjem te izravnim svjetlom, ON/OFF touch senzorom, funkcijom odmagljivanja, LED rasvjetom u boji 3000K-4000K ili 6000K s opcijom prigušivanja svjetla, IP44. Raspoloživo u dimenzijama 45x45, 65x60, 65x80, 75x75, 65x100, 65x120, 65x140, 65x160, 65x180.		

RASPOLOŽIVE BOJE I ZAVRŠNE OBRADJE

● Krom

○ Crna mat

● Zlatna

● Četkana brončana

● Bijela mat

▨ Četkana crna

● Četkana zlatna

● Nehrdajući čelik

● Grafitna crna

● Kamen siva

● Beton siva

A dark, moody photograph of a kitchen mixer. The image is mostly in shadow, with a textured surface, possibly a mixer head or a bowl, visible. The lighting is soft and directional, highlighting the texture and some metallic parts. The overall tone is monochromatic and artistic.

MIJEŠALICE

HANSGROHE

FOCUS

Focus je osnovna kolekcija miješalica koja omogućuje opremanje vaše kupaonice dizajnerskim proizvodima, po povoljnim cijenama.

Focus olakšava vašu svakodnevicu te se lako prilagođava bilo kojem stilu uređenja radi jednostavnog i funkcionalnog dizajna.



HANSGROHE FOCUS



●
Ⓛ
192671
95,37 718,60

Focus 70

Miješalica za umivaonik s piletom i podizačem, krom.



●
Ⓛ
261573
115,76 872,21

Focus 100

Miješalica za umivaonik s piletom i podizačem, krom.



●
Ⓛ
261574
160,12 1.206,44

Focus 190

Miješalica za umivaonik s piletom i podizačem, krom.

Boja
Dostupnost
Šifra artikla
MPC (€) MPC (Kn)



●
Ⓛ
192677
100,55 757,57

Focus

Miješalica za bide s piletom i podizačem, krom.



●
Ⓛ
192679
120,71 909,45

Focus

Miješalica za kadu, krom.



●
Ⓛ
192683
101,16 762,22

Focus

Miješalica za tuš, krom.

Boja
Dostupnost
Šifra artikla
MPC (€) MPC (Kn)



●	Boja
Ⓛ	Dostupnost
192680	Šifra artikla
123,79 932,73	MPC (€) MPC (Kn)

Focus

Miješalica za tuš ili kadu s prebacivačem za podžbuknu instalaciju, krom.



HANSGROHE

TALIS S

Talis S ima specifičan dizajn miješalice koji je nagnut prema dolje te ima izljev koji se stapa s tijelom istog oblika. Ljepota ove kolekcije upravo je u jednostavnosti.

Kao i kod ostalih Hansgrohe miješalica, i Talis S miješalice proizvode mlaz vode koji je pomiješan sa zrakom pa se tako dobiva lagan i nježan pad vode. Različite dimenzije u kolekciji nude idealne kombinacije sa željenim umivaonikom.



HANSGROHE Talis S 190 | miješalica za umivaonik | krom

HANSGROHE TALIS S



●
435697
213,93 1.611,88

Talis S 100

Miješalica za umivaonik s piletom i podizačem, krom.



●
435698
327,68 2.468,92

Talis S 190

Miješalica za umivaonik s piletom i podizačem, krom.



●
442524
312,21 2.352,38

Talis S

Zidna miješalica za umivaonik s izljevom 22.5 cm za podžbuknu instalaciju, krom.

Boja
Dostupnost
Šifra artikla
MPC (€) MPC (Kn)



●
442530
213,93 1.611,88

Talis S

Miješalica za bide s piletom i podizačem, krom.



●
442533
270,09 2.035,02

Talis S

Miješalica za kadu, krom.



●
442543
213,93 1.611,88

Talis S

Miješalica za tuš, krom.

Boja
Dostupnost
Šifra artikla
MPC (€) MPC (Kn)



●
442534
221,67 1.670,15

Talis S

Miješalica za tuš ili kadu s prebacivačem za podžbuknu instalaciju, krom.

Boja
Dostupnost
Šifra artikla
MPC (€) MPC (Kn)

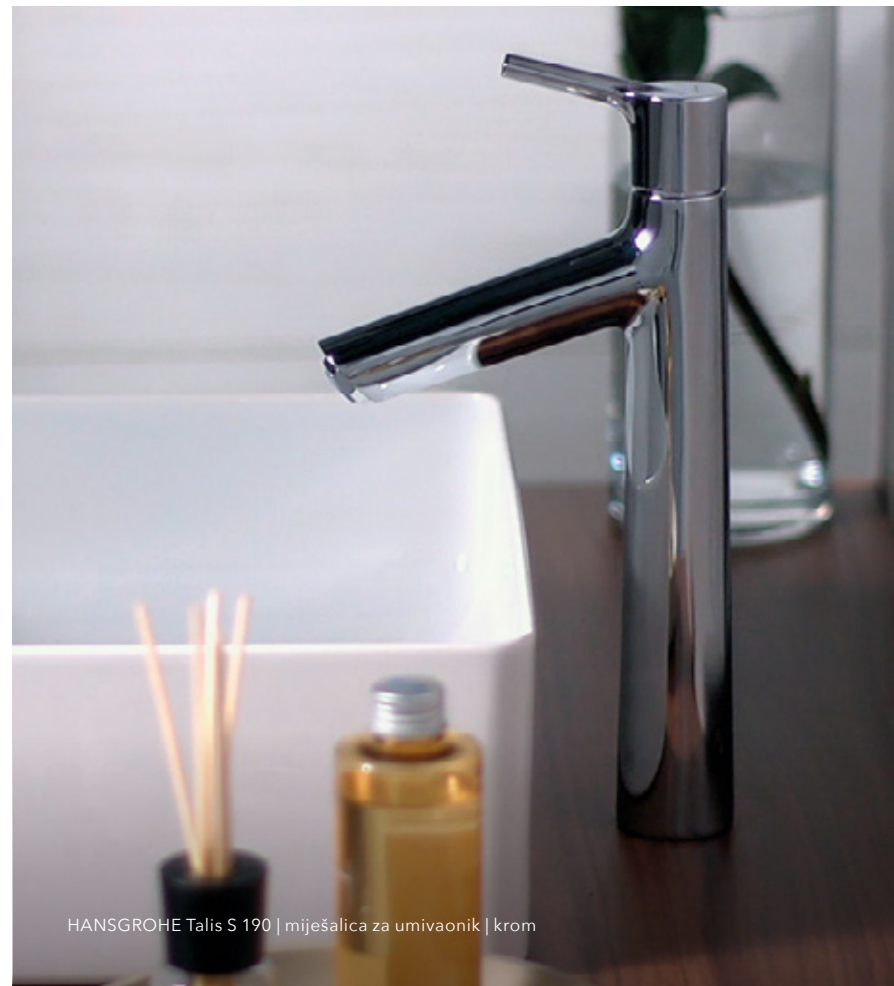

HANSGROHE Talis S 190 | miješalica za umivaonik | krom

HANSGROHE

VIVENIS

Vivenis kolekcija radi svojeg specifičnog dizajna kao krajnji rezultat dobiva mlaz vode koji podsjeća na vodopad. Kao i uvijek, najljepše inspiracije dolaze nam iz prirode.

Trenutak wellnessa omogućen je u svakom pranju ruku, jutarnjem umivanju ili pod tušem.



HANSGROHE Vivenis 250 | miješalica za umivaonik | krom | 

HANSGROHE VIVENIS





● ● ○
Ⓛ
889056
156,26 1.177,32

Vivenis 110
Miješalica za umivaonik, krom.



● ● ○
Ⓛ
889071
244,04 1.838,73

Vivenis 250
Miješalica za umivaonik, krom.



● ● ○	Boja
Ⓛ	Dostupnost
889074	Šifra artikla
224,38 1.690,56	MPC (€) MPC (Kn)

Vivenis
Zidna miješalica za umivaonik s izljevom 19.2 cm za podžbuknu instalaciju, krom.



● ● ○
Ⓛ
889077
207,54 1.563,68

Vivenis
Miješalica za bide s piletom i podizačem, krom.



● ● ○
Ⓛ
889089
274,51 2.068,28

Vivenis
Miješalica za kadu, krom.



● ● ○	Boja
Ⓛ	Dostupnost
889101	Šifra artikla
192,32 1.449,04	MPC (€) MPC (Kn)

Vivenis
Miješalica za tuš, krom.



● ● ○
Ⓛ
889083
177,90 1.340,37

Vivenis
Miješalica za tuš ili kadu s prebacivačem za podžbuknu instalaciju, krom.



● ● ○	Boja
	Dostupnost
889095	Šifra artikla
1.667,77 12.565,84	MPC (€) MPC (Kn)

Vivenis
Podna miješalica za kadu za podžbuknu instalaciju, krom.



Hansgrohe Vivenis 110 miješalica za umivaonik | crna mat | 889057 | 218,67 € | 1.647,60 kn | Ⓛ



Hansgrohe Vivenis zidna miješalica za umivaonik s izljevom 19,2 cm za podžbuknu instalaciju | crna mat | 889075 | 314,14 € | 2.366,87 kn | Ⓛ

HANSGROHE

TALIS E





















































































Nježno oblikovano tijelo miješalice prelazi u graciozan izljev raskošne površine. Izljev i ručku krasi oštri, precizni rubovi.

Ova kolekcija idalno odgovara modernim ambijentima, a širok spektar boja omogućava dodatno igranje dizajnom. Od mat crne ili bijele, sve do brončane i zlatne, Talis E zadovoljava sve.



HANSGROHE TALIS E



 <table border="1" data-bbox="451 376 578 590"> <tr> <td></td> </tr> <tr> <td></td> </tr> <tr> <td>442469</td> </tr> <tr> <td>116,30 876,28</td> </tr> </table> <p>Talis E 110</p> <p>Miješalica za umivaonik s piletom i podizačem, krom.</p>			442469	116,30 876,28	 <table border="1" data-bbox="879 376 1006 590"> <tr> <td></td> </tr> <tr> <td></td> </tr> <tr> <td>826842</td> </tr> <tr> <td>166,84 1.257,03</td> </tr> </table> <p>Talis E 110</p> <p>Miješalica za umivaonik s piletom i podizačem, crna mat.</p>			826842	166,84 1.257,03	 <table border="1" data-bbox="1306 376 1434 590"> <tr> <td></td> </tr> <tr> <td></td> </tr> <tr> <td>826844</td> </tr> <tr> <td>174,35 1.313,64</td> </tr> </table> <p>Talis E 110</p> <p>Miješalica za umivaonik s piletom i podizačem, zlatna.</p>			826844	174,35 1.313,64	<table border="1"> <tr> <td>Boja</td> </tr> <tr> <td>Dostupnost</td> </tr> <tr> <td>Šifra artikla</td> </tr> <tr> <td>MPC (€) MPC (Kn)</td> </tr> </table>	Boja	Dostupnost	Šifra artikla	MPC (€) MPC (Kn)
																			
																			
442469																			
116,30 876,28																			
																			
																			
826842																			
166,84 1.257,03																			
																			
																			
826844																			
174,35 1.313,64																			
Boja																			
Dostupnost																			
Šifra artikla																			
MPC (€) MPC (Kn)																			
 <table border="1" data-bbox="451 804 578 1018"> <tr> <td></td> </tr> <tr> <td></td> </tr> <tr> <td>434550</td> </tr> <tr> <td>194,36 1.464,44</td> </tr> </table> <p>Talis E 240</p> <p>Miješalica za umivaonik s piletom i podizačem, krom.</p>			434550	194,36 1.464,44	 <table border="1" data-bbox="879 804 1006 1018"> <tr> <td></td> </tr> <tr> <td></td> </tr> <tr> <td>612255</td> </tr> <tr> <td>272,11 2.050,18</td> </tr> </table> <p>Talis E 240</p> <p>Miješalica za umivaonik s piletom i podizačem, crna mat.</p>			612255	272,11 2.050,18	 <table border="1" data-bbox="1306 804 1434 1018"> <tr> <td></td> </tr> <tr> <td></td> </tr> <tr> <td>826862</td> </tr> <tr> <td>291,65 2.197,43</td> </tr> </table> <p>Talis E 240</p> <p>Miješalica za umivaonik s piletom i podizačem, zlatna.</p>			826862	291,65 2.197,43	<table border="1"> <tr> <td>Boja</td> </tr> <tr> <td>Dostupnost</td> </tr> <tr> <td>Šifra artikla</td> </tr> <tr> <td>MPC (€) MPC (Kn)</td> </tr> </table>	Boja	Dostupnost	Šifra artikla	MPC (€) MPC (Kn)
																			
																			
434550																			
194,36 1.464,44																			
																			
																			
612255																			
272,11 2.050,18																			
																			
																			
826862																			
291,65 2.197,43																			
Boja																			
Dostupnost																			
Šifra artikla																			
MPC (€) MPC (Kn)																			
 <table border="1" data-bbox="451 1225 578 1439"> <tr> <td></td> </tr> <tr> <td></td> </tr> <tr> <td>442482</td> </tr> <tr> <td>184,27 1.388,40</td> </tr> </table> <p>Talis E</p> <p>Zidna miješalica za umivaonik s izljevom 22.5 cm za podžbuknu instalaciju, krom.</p>			442482	184,27 1.388,40	 <table border="1" data-bbox="879 1225 1006 1439"> <tr> <td></td> </tr> <tr> <td></td> </tr> <tr> <td>826880</td> </tr> <tr> <td>258,04 1.944,21</td> </tr> </table> <p>Talis E</p> <p>Zidna miješalica za umivaonik s izljevom 22.5 cm za podžbuknu instalaciju, crna mat.</p>			826880	258,04 1.944,21	 <table border="1" data-bbox="1306 1225 1434 1439"> <tr> <td></td> </tr> <tr> <td></td> </tr> <tr> <td>826882</td> </tr> <tr> <td>276,45 2.082,95</td> </tr> </table> <p>Talis E</p> <p>Zidna miješalica za umivaonik s izljevom 22.5 cm za podžbuknu instalaciju, zlatna.</p>			826882	276,45 2.082,95	<table border="1"> <tr> <td>Boja</td> </tr> <tr> <td>Dostupnost</td> </tr> <tr> <td>Šifra artikla</td> </tr> <tr> <td>MPC (€) MPC (Kn)</td> </tr> </table>	Boja	Dostupnost	Šifra artikla	MPC (€) MPC (Kn)
																			
																			
442482																			
184,27 1.388,40																			
																			
																			
826880																			
258,04 1.944,21																			
																			
																			
826882																			
276,45 2.082,95																			
Boja																			
Dostupnost																			
Šifra artikla																			
MPC (€) MPC (Kn)																			
 <table border="1" data-bbox="451 1654 578 1868"> <tr> <td></td> </tr> <tr> <td></td> </tr> <tr> <td>442475</td> </tr> <tr> <td>116,30 876,28</td> </tr> </table> <p>Talis E</p> <p>Miješalica za bide s piletom i podizačem, krom.</p>			442475	116,30 876,28	 <table border="1" data-bbox="879 1654 1006 1868"> <tr> <td></td> </tr> <tr> <td></td> </tr> <tr> <td>826869</td> </tr> <tr> <td>191,86 1.445,57</td> </tr> </table> <p>Talis E</p> <p>Miješalica za bide s odvodnim setom i podizačem, crna mat.</p>			826869	191,86 1.445,57	 <table border="1" data-bbox="1306 1654 1434 1868"> <tr> <td></td> </tr> <tr> <td></td> </tr> <tr> <td>826871</td> </tr> <tr> <td>174,35 1.313,64</td> </tr> </table> <p>Talis E</p> <p>Miješalica za bide s piletom i podizačem, zlatna.</p>			826871	174,35 1.313,64	<table border="1"> <tr> <td>Boja</td> </tr> <tr> <td>Dostupnost</td> </tr> <tr> <td>Šifra artikla</td> </tr> <tr> <td>MPC (€) MPC (Kn)</td> </tr> </table>	Boja	Dostupnost	Šifra artikla	MPC (€) MPC (Kn)
																			
																			
442475																			
116,30 876,28																			
																			
																			
826869																			
191,86 1.445,57																			
																			
																			
826871																			
174,35 1.313,64																			
Boja																			
Dostupnost																			
Šifra artikla																			
MPC (€) MPC (Kn)																			

HANSGROHE TALIS E

**Talis E**

Miješalica za kadu, krom.

Ⓛ
439399
185,91 1.400,73

**Talis E**

Miješalica za tuš, crna mat.

Ⓛ
826905
188,38 1.419,32

**Talis E**

Miješalica za tuš, zlatna.

Ⓛ
826907
196,94 1.483,87

Boja

Dostupnost

Šifra artikla

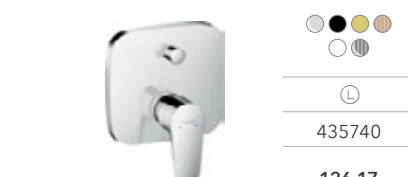
MPC (€)
MPC (Kn)**Talis E**

Miješalica za tuš ili kadu s prebacivačem za podžbuknu instalaciju, krom.

Ⓛ
435740
126,17 950,62

**Talis E**

Miješalica za tuš ili kadu s prebacivačem za podžbuknu instalaciju, crna mat.

Ⓛ
824790
176,55 1.330,23

**Talis E**

Miješalica za tuš ili kadu s prebacivačem za podžbuknu instalaciju, zlatna.

Ⓛ
826892
189,24 1.425,85

Boja

Dostupnost

Šifra artikla

MPC (€)
MPC (Kn)**Talis E**

Miješalica za tuš, krom.

Ⓛ
442491
131,20 988,49

Boja

Dostupnost

Šifra artikla

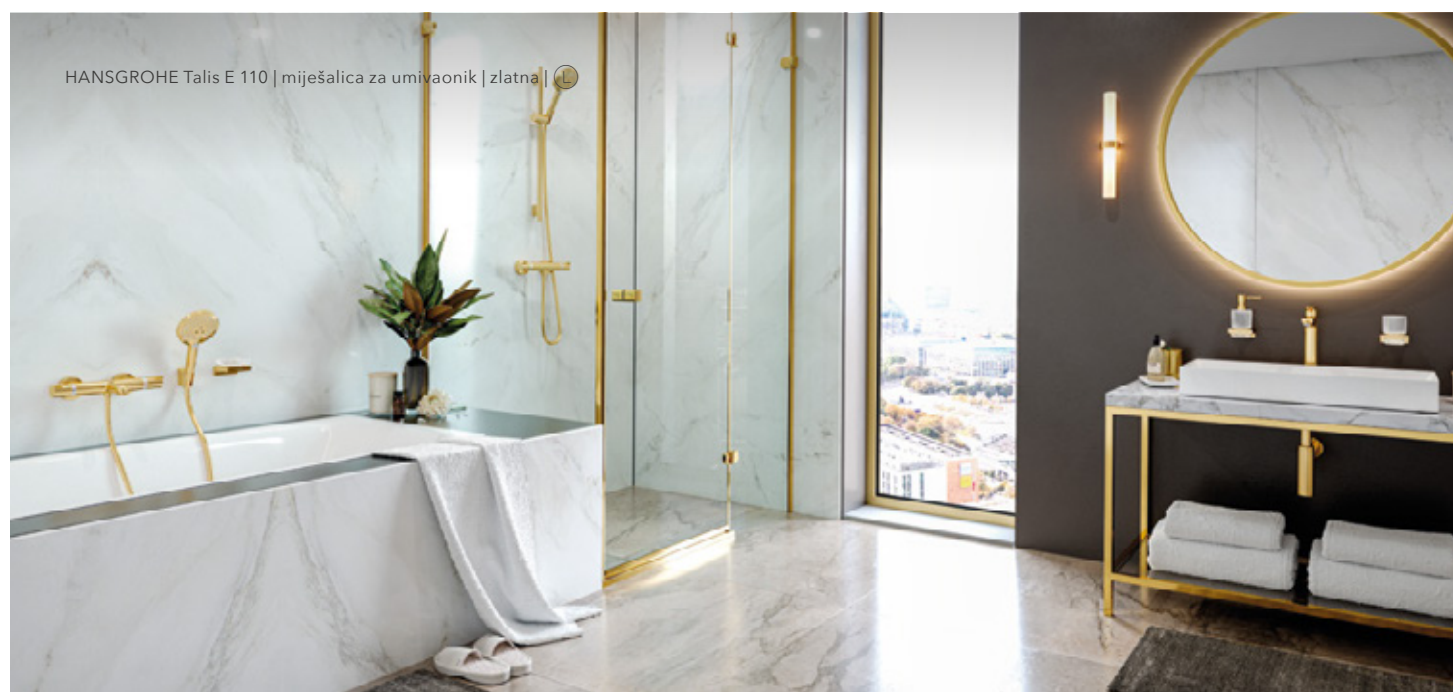
MPC (€)
MPC (Kn)



HANSGRÖHE Talis E 240 | Miješalica za umivaonik | krom | 

HANSGROHE METROPOL

Divna kolekcija Metropol savršen je odabir za one koji u svom dizajnu biraju oštre te jasne linije. Posebno lijepo pristaju geometrijski oblikovanom ambijentu kupaonice, no jednako dobro odgovaraju i uz kombinaciju uvojitih ili ovalnih struktura poput umivaonika.

Metropol nudi različite ručke te visine izljeva i ostavlja zadivljujući dizajnerski trag u vašem domu. Važno je istaknuti kako se ova kolekcija pojavljuje u FinishPlus obradama, od kojih su na našem lageru, uz krom, dostupne zlatna te mat crna boja.



HANSGROHE METROPOL



549620
237,95 1.792,85

Metropol 110

Miješalica za umivaonik s push-open piletom, krom.



826718
333,26 2.510,95

Metropol 110

Miješalica za umivaonik s push-open piletom, crna mat.



826721
357,02 2.689,98

Metropol 110

Miješalica za umivaonik s push-open piletom, zlatna.

Boja
Dostupnost
Šifra artikla
MPC (€) MPC (Kn)



549623
335,93 2.531,10

Metropol 260

Miješalica za umivaonik s push-open piletom, krom.



826729
470,27 3.543,27

Metropol 260

Miješalica za umivaonik s push-open piletom, crna mat.



826731
503,86 3.796,35

Metropol 260

Miješalica za umivaonik s push-open piletom, zlatna.

Boja
Dostupnost
Šifra artikla
MPC (€) MPC (Kn)



549628
298,67 2.250,35

Metropol

Zidna miješalica za umivaonik s izljevom 22.5 cm za podžbuknu instalaciju, krom.



826744
418,04 3.149,75

Metropol

Zidna miješalica za umivaonik s izljevom 22.5 cm za podžbuknu instalaciju, crna mat.



826746
447,96 3.375,18

Metropol

Zidna miješalica za umivaonik s izljevom 22.5 cm za podžbuknu instalaciju, zlatna.

Boja
Dostupnost
Šifra artikla
MPC (€) MPC (Kn)



549494
307,99 2.320,57

Metropol

Miješalica za bide s push-open piletom, krom.



826740
431,17 3.248,63

Metropol

Miješalica za bide s push-open piletom, crna mat.



826742
462,03 3.481,15

Metropol

Miješalica za bide s push-open piletom, zlatna.

Boja
Dostupnost
Šifra artikla
MPC (€) MPC (Kn)



HANSGROHE Metropol 110 | miješalica za umivaonik | crna mat | 

HANSGROHE METROPOL



549639

196,04
1.477,06

Metropol

Miješalica za tuš, krom.



826773

274,46
2.067,91

Metropol

Miješalica za tuš, crna mat.



826775

294,02
2.215,31

Metropol

Miješalica za tuš, zlatna.

Boja

Dostupnost

Šifra artikla

MPC (€)
MPC (Kn)



549632

196,04
1.477,06

Metropol

Miješalica za tuš ili kadu s prebacivačem za podžbuknu instalaciju, krom.



824568

274,46
2.067,91

Metropol

Miješalica za tuš ili kadu s prebacivačem za podžbuknu instalaciju, crna mat.



826765

294,02
2.215,31

Metropol

Miješalica za tuš ili kadu s prebacivačem za podžbuknu instalaciju, zlatna.

Boja

Dostupnost

Šifra artikla

MPC (€)
MPC (Kn)



549630

2.186,06
16.470,87

Metropol

Podna miješalica za kadu za podžbuknu instalaciju, krom.



826749

3.060,57
23.059,87

Metropol

Podna miješalica za kadu za podžbuknu instalaciju, crna mat.



826751

3.279,28
24.707,70

Metropol

Podna miješalica za kadu za podžbuknu instalaciju, zlatna.

Boja

Dostupnost

Šifra artikla

MPC (€)
MPC (Kn)



HANS GROHE Metropol 260 | miješalica za umivaonik | zlatna | ©

HANSGROHE

PULSIFY

Hansgrohe je razvio novu kolekciju tuševa Pulsify s kompaktnim dizajnom koji će savršeno odgovarati manjim kupatilima.

Zagarantiran je potpuno drugačiji doživljaj tuširanja jer se voda pretvara u nježne kapljice koje će opustiti vaše tijelo. Pulsify mikrokapljice ovu kolekciju čine posebnom, a dodatna prednost je što postoje tri boje prilikom odabira.

HANSGROHE Pulsify Select | tuš konzola | crna mat
 HANSGROHE Pulsify | nadglavni tuš 150 | crni mat
 HANSGROHE Pulsify | zidni priključak | crni mat



HANSGROHE PULSIFY



888520
44,62 336,19

Pulsify Select

Tuš ručka 105, 3 mlaza Relaxation, krom.



888556
121,00 911,66

Pulsify Select

Tuš konzola 65 cm s tuš ručkom 3 mlaza i tuš crijevom 160 cm, krom.



888571
1.037,34 7.815,82

Pulsify

Showerpipe tuš sustav 260 s 2 mlaza sa ShowerTablet Select 400, krom.

Boja
Dostupnost
Šifra artikla
MPC (€) MPC (Kn)



888568
913,84 6.885,36

Pulsify

Showerpipe tuš sustav 260, 1 mlaz sa ShowerTablet Select 400, krom.



888550
593,21 4.469,54

Pulsify

Nadglavni tuš 260 s 2 mlaza sa zidnim priključkom, krom.



888532
105,03 791,32

Pulsify

Nadglavni tuš 150, 1 mlaz, krom.

Boja
Dostupnost
Šifra artikla
MPC (€) MPC (Kn)



888538
63,66 479,62

Pulsify

Zidni priključak za nadglavni tuš 105, krom.

Boja
Dostupnost
Šifra artikla
MPC (€) MPC (Kn)

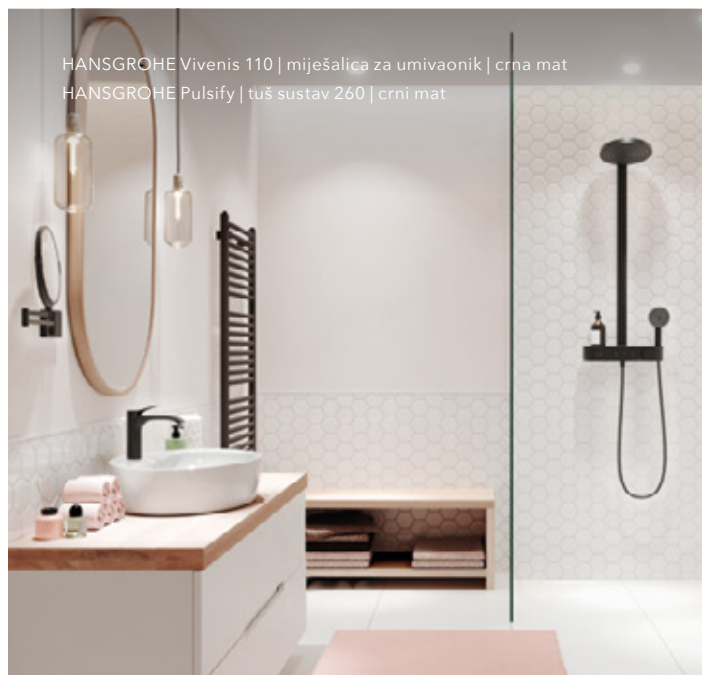

HANSGROHE

ZONA TUŠIRANJA



HANSGROHE

Hansgrohe svijet tuširanja nudi potpuno novi doživljaj u vašoj kupaonici. Tuširanje postaje luksuz.

Uz najnovije visoko postavljene trendove u modernoj kupaonici, neovisno o kojem se modelu tuša radi, Hansgrohe nudi wellness doživljaj te osjećaj kao da se kupate ispod nježnih kapi kiše. Ovakav doživljaj omogućavaju tuš ruže i ručke koje nude različite mogućnosti mlazova i podešavanja vode, onako kako to vama najviše odgovara.

Uz to je ponuđen zaista širok spektar dimenzija pa se tako pronalazi rješenje za svaku kupaonicu i za svaki ukus. Kada se govori o inovativnosti i tehnološkoj uspješnosti, Hansgrohe zaista odnosi prvo mjesto. Svojim lijepim dizajnom podiže kupaonice na višu razinu.

Hansgrohe je omiljen u svijetu kupaonica jer već desetljećima za cilj ima od tuširanja i korištenja vode stvoriti umjetnost.

HANSGROHE ZONA TUŠIRANJA

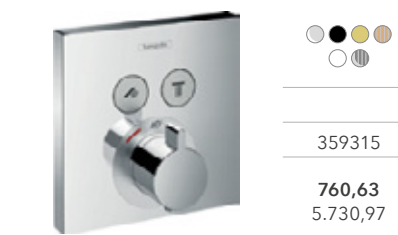

359315

760,63
5.730,97**ShowerSelect**

Termostatska miješalica za dva potrošača za podžbuknu instalaciju, krom.



435861

756,65
5.700,96**ShowerSelect**

Termostatska miješalica za dva potrošača za podžbuknu instalaciju, krom.



389667

931,42
7.017,77**ShowerSelect**

Termostatska miješalica za dva potrošača za podžbuknu instalaciju s priključkom za tuš crijevo i držačem tuš ručke, krom.

Boja

Dostupnost

Šifra artikla

MPC (€)
MPC (Kn)

289952

230,11
1.733,79**Croma 220**

Nadglavna okrugla tuš ruža, Ø 22 cm, krom.



485256

263,29
1.983,79**Croma 280**

Nadglavna okrugla tuš ruža, Ø 28 cm, EcoSmart, krom.



359320

432,88
3.261,55**Raindance Select S 240**

Nadglavna okrugla tuš ruža Ø 24 cm s nosačem iz zida dužine 39 cm, 2 mlaza, krom.

Boja

Dostupnost

Šifra artikla

MPC (€)
MPC (Kn)

329229

575,52
4.336,24**Raindance Select E 300**

Nadglavna tuš ruža 30x16 cm s nosačem iz zida dužine 39 cm, 2 mlaza, krom.



075111

71,23
536,66**Izljev**

Zidni izljev tuš ruže dužine 38.9 cm, krom.



192625

52,74
397,40**Crometta 85**

Tuš konzola 65 cm s tuš ručkom 2 mlaza i tuš crijevom 160 cm, krom.

Boja

Dostupnost

Šifra artikla

MPC (€)
MPC (Kn)

485293

56,40
424,94**Crometta Vario**

Tuš konzola 65 cm s posudicom za sapun, tuš ručkom 2 mlaza i tuš crijevom 160 cm, krom.



244515

77,05
580,51**Croma 100**

Tuš konzola 65 cm s posudicom za sapun, tuš ručkom 1 mlaz i tuš crijevom 160 cm, krom.



148261

91,72
691,07**Croma 100**

Tuš konzola 90 cm s posudicom za sapun, tuš ručkom 4 mlaza i tuš crijevom 160 cm, krom.

Boja

Dostupnost

Šifra artikla

MPC (€)
MPC (Kn)

HANSGROHE ZONA TUŠIRANJA



Ⓛ
117650
123,04 927,07

Unica S Puro

Šipka tuš konzole 65 cm s klizačem i tuš crijevom, krom.



Ⓛ
390656
111,46 839,76

Croma Select E

Tuš konzola 65 cm s tuš ručkom 3 mlaza i tuš crijevom 160 cm, bijela/krom.



Ⓛ
485314
444,99 3.352,80

Crometta S 240

Tuš konzola s termostatskom miješalicom, tuš ružom Ø 24 cm, tuš ručkom 1 mlaz i tuš crijevom 160 cm, krom.

Boja

Dostupnost

Šifra artikla

MPC (€)
MPC (Kn)

Ⓛ
458038
444,99 3.352,80

Crometta E 240

Tuš konzola s termostatskom miješalicom, tuš ružom 24x24 cm, tuš ručkom 1 mlaz i tuš crijevom 160 cm, krom.



Ⓛ
485309
777,14 5.855,33

Croma Select S 280

Tuš konzola s termostatskom miješalicom, tuš ružom Ø 28 cm, tuš ručkom 1 mlaz i tuš crijevom 160 cm, krom.

Boja

Dostupnost

Šifra artikla

MPC (€)
MPC (Kn)

HANSGROHE Croma Select S 280 | termostatska tuš konzola | krom | Ⓛ



HANSGROHE Croma 280 | nadglavna tuš ruža | krom | Ⓛ

HANSGROHE Zidni izljev tuš ruže | krom | Ⓛ

HANSGROHE FixFit S | priključak za | krom | Ⓛ

HANSGROHE Croma Select S | tuš ručka | bijela, krom | Ⓛ



HANSGROHE Raindance Select E 120 | tuš ručka | krom | (L)



HANSGROHE ZONA TUŠIRANJA



●
(L)
192664
19,19
144,57

Crometta 85

Tuš ručka 2 mlaza, krom.



●
(L)
148276
30,29
228,23

Croma 100 Vario

Tuš ručka 4 mlaza, krom.



●
(L)
390691
37,78
284,62

Croma Select S

Tuš ručka 1 mlaz EcoSmart, bijela/krom.

Boja
Dostupnost
Šifra artikla
MPC (€)
MPC (Kn)



●
(L)
390696
50,29
378,92

Croma Select E

Tuš ručka 3 mlaza EcoSmart, bijela/krom.



● ● ● ● ●
(L)
826563
70,87
533,97

Rainfinity

Tuš ručka Baton, 1 mlaz, krom.



● ● ● ● ●
(L)
359333
75,52
569,00

Raindance Select S 120

Tuš ručka 3 mlaza, krom.

Boja
Dostupnost
Šifra artikla
MPC (€)
MPC (Kn)



● ● ● ● ●
(L)
320917
75,52
569,00

Raindance Select E 120

Tuš ručka 3 mlaza, krom.



●
(L)
390682
123,34
929,27

Raindance Select E 120



Tuš set s ručkom 3 mlaza, tuš crijevom 160 cm i držačem tuš ručke, krom.



Boja
Dostupnost
Šifra artikla
MPC (€)
MPC (Kn)

HANSGROHE ZONA TUŠIRANJA



	
	
	075135
	22,29 167,96
FixFit E	
Priključak za tuš crijevo, krom.	

	
	
	212160
	39,75 299,52
FixFit	
Priključak za tuš crijevo, krom.	

		Boja
		Dostupnost
	117591	Šifra artikla
	24,71 186,20	MPC (€) MPC (Kn)
Porter S		
Nosač tuš ručke, krom.		



	
	
	826657
	39,86 300,33
Porter E	
Nosač tuš ručke, krom.	

	
	
	1049449
	79,77 601,03
FixFit Q	
Priključak za tuš crijevo s držačem tuš ručke, krom.	

		Boja
		Dostupnost
	1049450	Šifra artikla
	79,77 601,03	MPC (€) MPC (Kn)
FixFit S		
Priključak za tuš crijevo s držačem tuš ručke, krom.		



	
	
	1049448
	79,77 601,03
FixFit E	
Priključak za tuš crijevo s držačem tuš ručke, krom.	

	
	
	075266
	74,48 9,89
Metaflex	
Tuš crijevo 1.60 m, krom.	

		Boja
		Dostupnost
	075267	Šifra artikla
	21,84 164,52	MPC (€) MPC (Kn)
Isiflex		
Tuš crijevo 1.25 m, krom.		

	
	
	075275
	20,79 156,62
Isiflex	
Tuš crijevo 1.60 m, krom.	

	
	
	076287
	48,11 362,45
Pileta	
Push-open pileta za umivaonik i bide, krom.	

		Boja
		Dostupnost
	117785	Šifra artikla
	63,00 474,67	MPC (€) MPC (Kn)
Flowstar S		
Sifon za umivaonik, krom.		

HANSGROHE ZONA TUŠIRANJA

**Croma 280**

Nadglavna okrugla tuš ruža Ecosmart, Ø 22 cm, crna mat.

**Izljev**

Zidni nosač tuš ruže dužine 38.9 cm, crni mat.

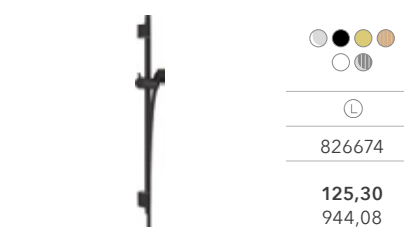
**Unica S Puro**

Šipka tuš konzole 65 cm s klizačem i tuš crijevom, crna mat.

**Rainfinity**

Tuš ručka Baton 100, 1 mlaz, crna mat.

**Raindance Select S 120**

Tuš ručka 3 mlaza, crna mat.

**Raindance Select E 120**

Tuš ručka 3 mlaza, crna mat.

**Porter S**

Nosač tuš ručke, crni mat.

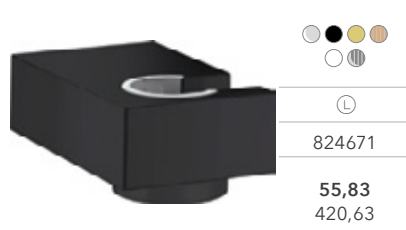
**Porter E**

Nosač tuš ručke, crni mat.

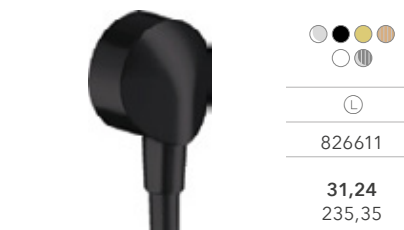
**FixFit E**

Priključak za tuš crijevo, crni mat.

**Isiflex B**

Tuš crijevo 160 cm, crno mat.

**Pileta**

Push-open pileta za umivaonik i bide, crna mat.

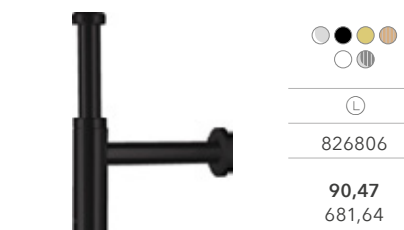
**Flowstar S**

Sifon za umivaonik, crni mat.

Boja

Dostupnost

Šifra artikla

MPC (€)
MPC (Kn)

Boja

Dostupnost

Šifra artikla

MPC (€)
MPC (Kn)

Boja

Dostupnost

Šifra artikla

MPC (€)
MPC (Kn)

Boja

Dostupnost

Šifra artikla

MPC (€)
MPC (Kn)

HANSGROHE ZONA TUŠIRANJA





826450
416,27 3.136,42

Croma 280

Nadglavna okrugla tuš ruža Ecosmart, Ø 22 cm, zlatna.







595606
106,98 806,06

Izljev

Zidni nosač tuš ruže dužine 38.9 cm, zlatni.



	Boja
	Dostupnost
826676	Šifra artikla
147,76 1.113,33	MPC (€) MPC (Kn)

Unica S Puro

Šipka tuš konzole 65 cm s klizačem i tuš crijevom, zlatna.





826568
106,23 800,39

Rainfinity

Tuš ručka Baton 100, 1 mlaz, zlatna.





595404
113,33 853,87

Raindance Select S 120

Tuš ručka 3 mlaza, zlatna.



	Boja
	Dostupnost
826506	Šifra artikla
113,33 853,87	MPC (€) MPC (Kn)

Raindance Select E 120

Tuš ručka 3 mlaza, zlatna.







595748
39,92 300,77

Porter S

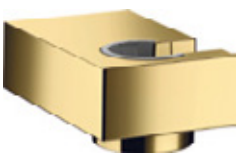
Nosač tuš ručke, zlatni.





826661
59,80 450,56

Porter E

Nosač tuš ručke, zlatni.



	Boja
	Dostupnost
595653	Šifra artikla
33,53 252,65	MPC (€) MPC (Kn)

FixFit E

Priključak za tuš crijevo, zlatni.





595732
31,16 234,78

Isiflex B

Tuš crijevo 160 cm, zlatno.







596046
72,24 544,32

Pileta

Push-open pileta za umivaonik i bide, zlatna.



	Boja
	Dostupnost
596069	Šifra artikla
100,52 757,40	MPC (€) MPC (Kn)

Flowstar S

Sifon za umivaonik, zlatni.



HANSGROHE Metropol

HANSGROHE ZONA TUŠIRANJA



Ibox

Podžbukni dio miješalice za tuš ili kadu.

Ⓛ
074266
76,88 579,27



Podžbukni element

Podžbukni dio zidne jednoručne miješalice za umivaonik.

Ⓛ
212050
163,47 1.231,63



Podžbukni element

Podžbukni dio podne miješalice za kadu.

Boja
Dostupnost
074349
Šifra artikla
436,52 3.288,96
MPC (€) MPC (Kn)

PAFFONI **GREEN**

Funkcionalnost proizvoda, dugotrajnost te najbolji kompromis cijene i kvalitete su ključni elementi kolekcije Green.

Suvremene miješalice koje čine bezvremensku klasu čest su odabir za kupaonice koje traže jednostavnost.



PAFFONI Green | miješalica za umivaonik | krom | 



PAFFONI Green | miješalica za umivaonik | krom | 

PAFFONI GREEN



Green

Miješalica za umivaonik s piletom i podizačem, krom.



Green

Miješalica za umivaonik s piletom i podizačem, produžena, krom.

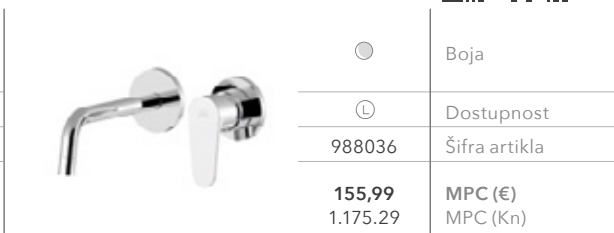

Green

Zidna miješalica za umivaonik s izljevom 24.5 cm i podžbuknim tijelom, krom.



Green

Miješalica za bide s piletom i podizačem, krom.



Green

Miješalica za kadu, krom.

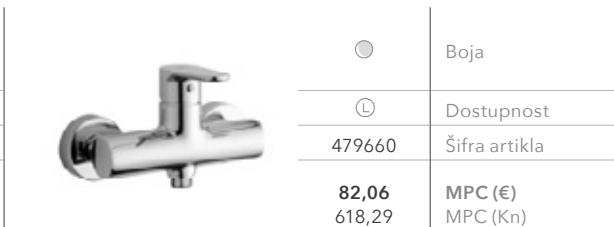

Green

Miješalica za tuš, krom.



Green

Miješalica za tuš ili kadu s prebacivačem i podžbuknim tijelom, krom.

PAFFONI

STICK

Čiste linije i jednostavnost dizajna prikazuju modernu, minimalističku miješalicu koja je ujedno vrlo praktična za uporabu.



Lijepa kolekcija Stick unijet će i dozu elegancije svojim finim i nježnim linijama.



PAFFONI Stick | miješalica za umivaonik | krom | 

PAFFONI STICK







311384
89,45 673,99

Stick

Miješalica za umivaonik s piletom i podizačem, krom.





987902
159,93 1.204,98

Stick

Zidna miješalica za umivaonik s izljevom 24.8 cm i podžbuknim tijelom, krom.





311395
89,45 673,99

Stick

Miješalica za bide s piletom i podizačem, krom.



Boja

Dostupnost

Šifra artikla

MPC (€)
MPC (Kn)







128391
127,29 959,04

Stick

Miješalica za kadu, krom.







128410
103,16 777,25

Stick

Miješalica za tuš, krom.





110449
112,39 846,84

Stick

Miješalica za tuš ili kadu s prebacivačem i podžbuknim tijelom, krom.

Boja

Dostupnost

Šifra artikla

MPC (€)
MPC (Kn)

PAFFONI





TANGO

Tango povlači novu liniju u kupaonskom svijetu koja se može uklopiti s elegancijom te se integrirati kao komad namještaja.

Nova interpretacija oblika stvara jednostavne i funkcionalne miješalice koje zadržavaju profinjenost.

PAFFONI TANGO



			<p>Boja</p> <hr/> <p>Dostupnost</p> <hr/> <p>Šifra artikla</p> <hr/> <p>MPC (€) MPC (Kn)</p>
<p>585581</p> <p>124,84 940,64</p> <p>Tango</p> <p>Miješalica za umivaonik, krom.</p>	<p>585585</p> <p>202,74 1.527,58</p> <p>Tango</p> <p>Miješalica za umivaonik, produžena, krom.</p>	<p>585595</p> <p>267,39 2.014,63</p> <p>Tango</p> <p>Zidna miješalica za umivaonik s izljevom 20 cm i podžbuknim tijelom, krom.</p>	
			<p>Boja</p> <hr/> <p>Dostupnost</p> <hr/> <p>Šifra artikla</p> <hr/> <p>MPC (€) MPC (Kn)</p>
<p>585599</p> <p>299,18 2.254,19</p> <p>Tango</p> <p>Zidna miješalica za umivaonik s izljevom 24 cm i podžbuknim tijelom, krom.</p>	<p>585605</p> <p>116,70 879,24</p> <p>Tango</p> <p>Miješalica za bide s piletom i podizačem, krom.</p>	<p>585563</p> <p>109,11 822,10</p> <p>Tango</p> <p>Miješalica za tuš ili kadu s prebacivačem i podžbuknim tijelom, krom.</p>	



PAFFONI LIGHT

Light kolekcija blista radi sklada i proporcija. Tanka ručica i oblik bez oštrih linija upotpunjavaju i podižu sve vrste uređenja vaše kupaonice.

Krom varijanta odličan je izbor za jednostavno uređenje kupaonice te se lako kombinira s elementima koji podsjećaju na drvo, kamen ili mramor.



PAFFONI LIGHT



Ⓛ
167152
111,40 839,34

Light

Miješalica za umivaonik, krom.



Ⓛ
167155
137,35 1.034,85

Light

Miješalica za umivaonik s piletom i podizačem, krom.



Ⓛ
167170
183,86 1.385,33

Light

Miješalica za umivaonik, produžena, krom.

Boja
Dostupnost
Šifra artikla
MPC (€) MPC (Kn)



Ⓛ
986022
154,44 1.163,64

Light

Zidna miješalica za umivaonik s izljevom 17.8 cm i podžbuknim tijelom, krom.



Ⓛ
986023
159,93 1.204,98

Light

Zidna miješalica za umivaonik s izljevom 24.8 cm i podžbuknim tijelom, krom.



Ⓛ
167194
139,64 1.052,08

Light

Mijenalica za bide s piletom i podizačem, krom.

Boja
Dostupnost
Šifra artikla
MPC (€) MPC (Kn)



Ⓛ
167134
207,99 1.567,11

Light

Miješalica za kadu, krom.



Ⓛ
167206
157,92 1.189,82

Light

Miješalica za tuš, krom.



Ⓛ
167131
137,98 1.039,63

Light

Miješalica za tuš ili kadu s prebacivačem i podžbuknim tijelom, krom.

Boja
Dostupnost
Šifra artikla
MPC (€) MPC (Kn)



Boja
Dostupnost
311250
1.373,13 10.345,88
MPC (€) MPC (Kn)

Light

Podna miješalica za kadu za podžbuknu instalaciju, krom.



PAFFONI Light | zidna miješalica za umivaonik | zlatna

PAFFONI ROCK

Kolekcija inspirirana buntom rock glazbe, stvara miješalice koje imaju klasične elemente, ali dodaju i nove detalje kako bi se dobilo nešto potpuno novo i briljantno.







Inovativne geometrije uljepšavaju kontekst kao što glazbeni solo obogaćuje melodiju.



PAFFONI Rock | miješalica za umivaonik | krom | 

PAFFONI ROCK



 <p>Rock Miješalica za umivaonik, krom.</p>	 <p>Rock Miješalica za umivaonik, produžena, krom.</p>	 <p>Rock Zidna miješalica za umivaonik s izljevom 24 cm i podžbuknim tijelom, krom.</p>	 <p>Boja Dostupnost Šifra artikla MPC (€) MPC (Kn)</p>
 <p>Rock Zidna miješalica za umivaonik s izljevom 24 cm i podžbuknim tijelom, krom.</p>	 <p>Rock Miješalica za bide s piletom i podizačem, krom.</p>	 <p>Rock Miješalica za tuš ili kadu s prebacivačem i podžbuknim tijelom, krom.</p>	<p>Boja Dostupnost Šifra artikla MPC (€) MPC (Kn)</p>

PAFFONI

TILT

Ova kolekcija pruža igru sa svjetlosti. U dodiru sa svjetlom ili suncem, stvara se odsjaj na mekim, linearnim površinama miješalica.

Formalni oblici dobivaju na ljepoti radi posebno rađenih rubova, a ujedno su i vrlo jednostavne za rukovanje.

PAFFONI TILT



988517

140,28
1.056,95

Tilt

Miješalica za umivaonik, krom.



988526

227,08
1.710,91

Tilt

Miješalica za umivaonik, produžena, krom.



988553

373,98
2.817,74

Tilt

Zidna miješalica za umivaonik s izljevom 24 cm i podžbuknim tijelom, krom.

Boja

Dostupnost

Šifra artikla

MPC (€)
MPC (Kn)



988559

140,28
1.056,95

Tilt

Miješalica za bide, krom.



988468

517,68
3.900,43

Tilt

Miješalica za kadu s izljevom i tuš ručkom, krom.

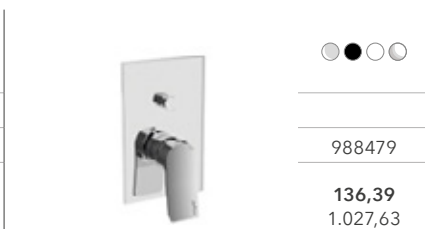

988479

136,39
1.027,63

Tilt

Miješalica za tuš ili kadu s prebacivačem i podžbuknim tijelom, krom.

Boja

Dostupnost

Šifra artikla

MPC (€)
MPC (Kn)



PAFFONI Tilt | zidna miješalica za umivaonik | krom



PAFFONI Tilt | miješalica za umivaonik | crna mat

PAFFONI JOKER

Kolekcija je ovo koju karakteriziraju zanimljive ručkice. Šuplji, okrugli oblici nastaju iz potrebe za jednostavnošću. Ipak, u svojoj jednostavnosti zadržavaju eleganciju te kolekcija ostaje dosljedna Paffonijevom lijepom stilu dizajniranja.



PAFFONI Joker | zidna miješalica za umivaonik | krom

PAFFONI JOKER

988091
153,07 1.153,31

Joker
Miješalica za umivaonik, krom.



988097
250,17 1.884,88

Joker
Miješalica za umivaonik, produžena, krom.



	Boja
	Dostupnost
988112	Šifra artikla
199,91 1.506,23	MPC (€) MPC (Kn)

Joker
Zidna miješalica za umivaonik s izljevom 24.8 cm i podžbuknim tijelom, krom.





988111
249,00 1.876,10

Joker
Zidna miješalica za umivaonik s izljevom 24.8 cm i podžbuknim tijelom, krom.





988115
153,07 1.153,31

Joker
Miješalica za bide, krom.



	Boja
	Dostupnost
988056	Šifra artikla
502,82 3.788,50	MPC (€) MPC (Kn)

Joker
Miješalica za kadu s izljevom i tuš ručkom, krom.



988067
172,48 1.299,54

Joker
Miješalica za tuš ili kadu s prebacivačem i podžbuknim tijelom, krom.



	Boja
	Dostupnost
988083	Šifra artikla
1.373,13 10.345,88	MPC (€) MPC (Kn)

Joker
Podna miješalica za kadu za podžbuknu instalaciju, krom.



PAFFONI JO

Okrugle površine nadopunjene su zanimljivim uzorkom radi kojeg se ova kolekcija već na prvi pogled znatno razlikuje od ostalih.

Njezina je najveća prednost što, radi svog pomaknutog dizajna, može udovoljiti tradicionalnim jednako kao i vrlo modernim uređenjima.



PAFFONI Jo | zidna miješalica za umivaonik | crna mat

PAFFONI JO





988175
159,93 1.204,98

Jo

Miješalica za umivaonik, krom.



988181
257,00 1.936,35

Jo

Miješalica za umivaonik, produžena, krom.



	Boja
	Dostupnost
988196	Šifra artikla
199,91 1.506,23	MPC (€) MPC (Kn)

Jo

Zidna miješalica za umivaonik s izljevom 24.8 cm i podžbuknim tijelom, krom.



988195
249,00 1.876,10

Jo

Zidna miješalica za umivaonik s izljevom 24.8 cm i podžbuknim tijelom, krom.





988138
221,60 1.669,61

Jo

Zidna miješalica za umivaonik s izljevom 24.5 cm i podžbuknim tijelom, krom.



	Boja
	Dostupnost
988201	Šifra artikla
159,93 1.204,98	MPC (€) MPC (Kn)

Jo

Miješalica za bide, krom.



988129
502,82 3.788,50

Jo

Miješalica za kadu s izljevom i tuš ručkom, krom.





988145
172,48 1.299,54

Jo

Miješalica za tuš ili kadu s prebacivačem i podžbuknim tijelom, krom.



	Boja
	Dostupnost
988161	Šifra artikla
1.373,13 10.345,88	MPC (€) MPC (Kn)

Jo

Podna miješalica za kadu za podžbuknu instalaciju, krom.



PAFFONI RINGO



PAFFONI Ringo | miješalica za umivaonik | crna mat | 

PAFFONI RINGO



	● ○		● ○		● ○	<table border="1"> <tr><td>Boja</td></tr> <tr><td>Dostupnost</td></tr> <tr><td>Šifra artikla</td></tr> <tr><td>MPC (€)</td></tr> <tr><td>MPC (Kn)</td></tr> </table>	Boja	Dostupnost	Šifra artikla	MPC (€)	MPC (Kn)
	Boja										
Dostupnost											
Šifra artikla											
MPC (€)											
MPC (Kn)											
Ⓛ	Ⓛ	Ⓛ	Ⓛ	Ⓛ							
311311	311325	311331	311331	311331	311331						
116,23 875,73	135,33 1.019,68	135,33 1.019,68	201,76 1.520,19	201,76 1.520,19	201,76 1.520,19						
Ringo	Ringo	Ringo	Ringo	Ringo	Ringo						
Miješalica za umivaonik, crna mat.	Miješalica za umivaonik s piletom i podizačem, crna mat.	Miješalica za umivaonik, produžena, crna mat.	Miješalica za umivaonik, produžena, crna mat.	Miješalica za umivaonik, produžena, crna mat.	Miješalica za umivaonik, produžena, crna mat.						
			● ○	<table border="1"> <tr><td>Boja</td></tr> <tr><td>Dostupnost</td></tr> <tr><td>Šifra artikla</td></tr> <tr><td>MPC (€)</td></tr> <tr><td>MPC (Kn)</td></tr> </table>	Boja	Dostupnost	Šifra artikla	MPC (€)	MPC (Kn)		
			Boja								
Dostupnost											
Šifra artikla											
MPC (€)											
MPC (Kn)											
Ⓛ	Ⓛ	Ⓛ	Ⓛ	Ⓛ							
584642	311345	311293	311293	311293	311293						
368,26 2.774,65	135,33 1.019,68	227,27 1.712,35	227,27 1.712,35	227,27 1.712,35	227,27 1.712,35						
Ringo	Ringo	Ringo	Ringo	Ringo	Ringo						
Zidna miješalica za umivaonik s izljevom 24 cm i podžbuknim tijelom, crna mat.	Miješalica za bide s piletom i podizačem, crna mat.	Miješalica za kadu, crna mat.	Miješalica za kadu, crna mat.	Miješalica za kadu, crna mat.	Miješalica za kadu, crna mat.						
		● ○	<table border="1"> <tr><td>Boja</td></tr> <tr><td>Dostupnost</td></tr> <tr><td>Šifra artikla</td></tr> <tr><td>MPC (€)</td></tr> <tr><td>MPC (Kn)</td></tr> </table>	Boja	Dostupnost	Šifra artikla	MPC (€)	MPC (Kn)			
		Boja									
Dostupnost											
Šifra artikla											
MPC (€)											
MPC (Kn)											
Ⓛ	Ⓛ	Ⓛ	Ⓛ	Ⓛ							
311354	368971	368971	368971	368971	368971						
138,62 1.044,42	181,75 1.369,37	181,75 1.369,37	181,75 1.369,37	181,75 1.369,37	181,75 1.369,37						
Ringo	Ringo	Ringo	Ringo	Ringo	Ringo						
Miješalica za tuš, crna mat.	Miješalica za tuš ili kadu s prebacivačem i podžbuknim tijelom, crna mat.	Miješalica za tuš ili kadu s prebacivačem i podžbuknim tijelom, crna mat.	Miješalica za tuš ili kadu s prebacivačem i podžbuknim tijelom, crna mat.	Miješalica za tuš ili kadu s prebacivačem i podžbuknim tijelom, crna mat.	Miješalica za tuš ili kadu s prebacivačem i podžbuknim tijelom, crna mat.						

Jedinstven stil koji se stvara kombiniranjem novih oblika možete pronaći kod miješalica Ringo.

Otvorena ručka ovu kolekciju čini drugačijom od drugih. Kada zanimljivom dizajnu pridodamo crnu boju, miješalice dobivaju još snažniji karakter.



PAFFONI Ringo | miješalica za umivaonik produžena | crna mat | Ⓛ

PAFFONI LIGHT

Osim krom boje, Light je dostupan i u mat crnoj varijanti. Miješalice u crnoj boji postižu poseban efekt te nikada ne ostaju nezamijećene. Jednostavno se kombiniraju i upotpunjavaju s mnogo boja koje se često nađu u interijeru.

Crni elementi u vašoj kupaonici podići će vizualni dojam na novu razinu.



PAFFONI LIGHT CRNO





Boja

Dostupnost
584956
Šifra artikla
144,85 1.091,34
MPC (€) MPC (Kn)

Light
Miješalica za umivaonik, crna mat.



Boja

Dostupnost
584959
Šifra artikla
178,46 1.344,63
MPC (€) MPC (Kn)

Light
Miješalica za umivaonik s piletom i podizačem, crna mat.



Boja

Dostupnost
584970
Šifra artikla
238,96 1.800,45
MPC (€) MPC (Kn)

Light
Miješalica za umivaonik, produžena, crna mat.



Boja

Dostupnost
986024
Šifra artikla
200,77 1.512,69
MPC (€) MPC (Kn)

Light
Zidna miješalica za umivaonik s izljevom 17.8 cm i podžbuknim tijelom, crna mat.



Boja

Dostupnost
986025
Šifra artikla
207,89 1.566,31
MPC (€) MPC (Kn)

Light
Zidna miješalica za umivaonik s izljevom 24.8 cm i podžbuknim tijelom, crna mat.



Boja

Dostupnost
585004
Šifra artikla
181,58 1.368,09
MPC (€) MPC (Kn)

Light
Miješalica za bide s piletom i podizačem, crna mat.



Boja

Dostupnost
584926
Šifra artikla
270,48 2.037,93
MPC (€) MPC (Kn)

Light
Miješalica za kadu, crna mat.



Boja

Dostupnost
585018
Šifra artikla
205,32 1.547,00
MPC (€) MPC (Kn)

Light
Miješalica za tuš, crna mat.



Boja

Dostupnost
578880
Šifra artikla
179,48 1.352,29
MPC (€) MPC (Kn)

Light
Miješalica za tuš ili kadu s prebacivačem i podžbuknim tijelom, crna mat.



Boja

Dostupnost
578932
Šifra artikla
1.786,06 13.457,08
MPC (€) MPC (Kn)

Light
Podna miješalica za kadu za podžbuknu instalaciju, crna mat.



PAFFONI ZONA TUŠIRANJA



Tuširanje je postalo mnogo više od samog održavanja higijene. Upravo iz tog razloga, kako bi ponudili više i bolje, Paffoni proizvodi donose nježnost i ugodu ispod mekanih kapljica vode. Radnje u kupaonici, koje uključuju korištenje vode, postaju jedan od oblika opuštanja. Ugodaj postaje još ljepši kada opuštanje prati i suvremeni dizajn ugodan oku.

Paffoni svijet tuširanja nudi različite mogućnosti, bilo da se radi o termostatskim konzolama ili jednostavnim miješalicama za tuševe i kade. U različitim bojama te različitim dimenzijama, rješenje za svaku kupaonicu je tu.

PAFFONI ZONA TUŠIRANJA

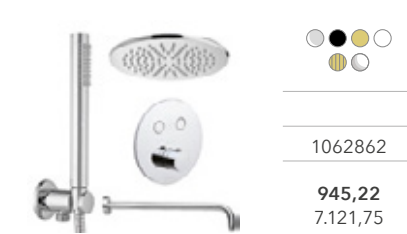

1062862
945,22 7.121,75

Compact Box

Set sadrži termostatsku miješalicu za dva potrošača za podžbuknu instalaciju, priključak s tuš ručkom i tuš crijevom 150 cm, nadglavnu okruglu tuš ružu Ø 22.5 cm, zidni izljev tuš ruže dužine 40 cm, krom.



Ⓛ
311782
59,67 449,59

Wind

Nadglavna okrugla tuš ruža, Ø 15 cm, krom.



Ⓛ
167930
97,23 732,56

Master

Nadglavna okrugla tuš ruža, Ø 22.5 cm, krom.

Boja

Dostupnost

Šifra artikla

MPC (€)

MPC (Kn)



Ⓛ
167931
111,10 837,10

Syncro

Nadglavna kvadratna tuš ruža, 20x20 cm, krom.



Ⓛ
038848
30,06 226,47

Medio

Zidni izljev tuš ruže dužine 15 cm, krom.



Ⓛ
038851
10,38 78,20

Izljev

Zidni izljev tuš ruže dužine 20 cm, krom.

Boja

Dostupnost

Šifra artikla

MPC (€)

MPC (Kn)



Ⓛ
038863
44,65 336,44

Lusso

Zidni izljev tuš ruže dužine 30 cm, krom.



Ⓛ
038862
51,43 387,51

Lusso

Zidni izljev tuš ruže dužine 40 cm, krom.



Ⓛ
129066
80,94 609,83

Quadro

Zidni izljev tuš ruže dužine 40 cm, krom.

Boja

Dostupnost

Šifra artikla

MPC (€)

MPC (Kn)



Ⓛ
218123
66,13 498,27

Panama

Tuš konzola 76 cm s tuš ručkom i tuš crijevom 150 cm, krom.



Ⓛ
218125
131,10 987,76

Life

Tuš konzola 75 cm s tuš ručkom i tuš crijevom 150 cm, krom.



Ⓛ
824102
264,78 1.995,00

Birillo Cold

Tuš konzola s termostatskom miješalicom, tuš ružom Ø 20 cm, tuš ručkom i tuš crijevom 150 cm, krom.

Boja

Dostupnost

Šifra artikla

MPC (€)

MPC (Kn)

PAFFONI ZONA TUŠIRANJA





479995
517,72 3.900,78

Mini Birillo

Tuš konzola s termostatskom miješalicom, tuš ružom Ø 22.5 cm, tuš ručkom i tuš crijevom 150 cm, krom.







311595
73,02 550,14

Tondo

Priključak s tuš ručkom i tuš crijevom 150 cm, krom.



	Boja
	Dostupnost
311596	Šifra artikla
75,66 570,09	MPC (€) MPC (Kn)

Quadro

Priključak s tuš ručkom i tuš crijevom 150 cm, krom.







218163
41,26 310,90

Tondo

Nosač tuš ručke, okrugli, krom.







218164
44,33 334,04

Quadro

Nosač tuš ručke, kvadratni, krom.





	Boja
	Dostupnost
037781	Šifra artikla
11,97 90,17	MPC (€) MPC (Kn)

Lux

Priključno koljeno, krom.





585827
111,63 841,09

Tweet Round Mix

Set za bide, krom.



368959
102,35 771,19

Podžbukni element

Podžbukni dio miješalice za tuš ili kadu.



















































	Boja
	Dostupnost
311248	Šifra artikla
241,00 1.815,85	MPC (€) MPC (Kn)

Podžbukni element

Podžbukni dio podne miješalice za kadu.



PAFFONI ZONA TUŠIRANJA

 <table border="1" data-bbox="451 376 578 597"> <tr><td></td></tr> <tr><td>Ⓛ</td></tr> <tr><td>1062863</td></tr> <tr><td>1.224,38 9.225,08</td></tr> </table> <p>Compact Box</p> <p>Set sadrži termostatsku miješalicu za dva potrošača za podžbuknu instalaciju, priključak s tuš ručkom i tuš crijevom 150 cm, nadglavnu okruglu tuš ružu Ø 22.5 cm, zidni izljev tuš ruže dužine 40 cm, crni mat.</p>		Ⓛ	1062863	1.224,38 9.225,08	 <table border="1" data-bbox="880 399 997 597"> <tr><td></td></tr> <tr><td>Ⓛ</td></tr> <tr><td>480146</td></tr> <tr><td>133,01 1.002,13</td></tr> </table> <p>Master</p> <p>Nadglavna okrugla tuš ruža, Ø 22.5 cm, crna mat.</p>		Ⓛ	480146	133,01 1.002,13	 <table border="1" data-bbox="1306 399 1423 597"> <tr><td></td></tr> <tr><td>Ⓛ</td></tr> <tr><td>480148</td></tr> <tr><td>144,42 1.088,15</td></tr> </table> <p>Syncro</p> <p>Nadglavna kvadratna tuš ruža, 20x20 cm, crna mat.</p> <table border="1" data-bbox="1441 376 1628 597"> <tr><td>Boja</td></tr> <tr><td>Dostupnost</td></tr> <tr><td>Šifra artikla</td></tr> <tr><td>MPC (€) MPC (Kn)</td></tr> </table>		Ⓛ	480148	144,42 1.088,15	Boja	Dostupnost	Šifra artikla	MPC (€) MPC (Kn)
																		
Ⓛ																		
1062863																		
1.224,38 9.225,08																		
																		
Ⓛ																		
480146																		
133,01 1.002,13																		
																		
Ⓛ																		
480148																		
144,42 1.088,15																		
Boja																		
Dostupnost																		
Šifra artikla																		
MPC (€) MPC (Kn)																		
 <table border="1" data-bbox="451 875 578 1073"> <tr><td></td></tr> <tr><td>Ⓛ</td></tr> <tr><td>480142</td></tr> <tr><td>69,84 526,20</td></tr> </table> <p>Lusso</p> <p>Zidni izljev tuš ruže dužine 40 cm, crni mat.</p>		Ⓛ	480142	69,84 526,20	 <table border="1" data-bbox="880 882 997 1073"> <tr><td></td></tr> <tr><td>Ⓛ</td></tr> <tr><td>480144</td></tr> <tr><td>110,47 832,31</td></tr> </table> <p>Quadro</p> <p>Zidni izljev tuš ruže dužine 40 cm, crni mat.</p>		Ⓛ	480144	110,47 832,31	 <table border="1" data-bbox="1306 875 1423 1073"> <tr><td></td></tr> <tr><td>Ⓛ</td></tr> <tr><td>585251</td></tr> <tr><td>177,66 1.338,57</td></tr> </table> <p>Life</p> <p>Tuš konzola 75 cm s tuš ručkom i tuš crijevom 150 cm, crna mat.</p> <table border="1" data-bbox="1441 875 1628 1073"> <tr><td>Boja</td></tr> <tr><td>Dostupnost</td></tr> <tr><td>Šifra artikla</td></tr> <tr><td>MPC (€) MPC (Kn)</td></tr> </table>		Ⓛ	585251	177,66 1.338,57	Boja	Dostupnost	Šifra artikla	MPC (€) MPC (Kn)
																		
Ⓛ																		
480142																		
69,84 526,20																		
																		
Ⓛ																		
480144																		
110,47 832,31																		
																		
Ⓛ																		
585251																		
177,66 1.338,57																		
Boja																		
Dostupnost																		
Šifra artikla																		
MPC (€) MPC (Kn)																		
 <table border="1" data-bbox="451 1304 578 1501"> <tr><td></td></tr> <tr><td>Ⓛ</td></tr> <tr><td>986241</td></tr> <tr><td>765,01 5.763,95</td></tr> </table> <p>Mini Birillo</p> <p>Tuš konzola s termostatskom miješalicom, tuš ružom Ø 22.5 cm, tuš ručkom i tuš crijevom 150 cm, crna mat.</p>		Ⓛ	986241	765,01 5.763,95	 <table border="1" data-bbox="880 1304 997 1501"> <tr><td></td></tr> <tr><td>Ⓛ</td></tr> <tr><td>480009</td></tr> <tr><td>111,10 837,10</td></tr> </table> <p>Tondo</p> <p>Priključak s tuš ručkom i tuš crijevom 150 cm, crno mat.</p>		Ⓛ	480009	111,10 837,10	 <table border="1" data-bbox="1306 1304 1423 1501"> <tr><td></td></tr> <tr><td>Ⓛ</td></tr> <tr><td>585121</td></tr> <tr><td>19,04 143,48</td></tr> </table> <p>Lux</p> <p>Priključno koljeno, crno mat.</p> <table border="1" data-bbox="1441 1304 1628 1501"> <tr><td>Boja</td></tr> <tr><td>Dostupnost</td></tr> <tr><td>Šifra artikla</td></tr> <tr><td>MPC (€) MPC (Kn)</td></tr> </table>		Ⓛ	585121	19,04 143,48	Boja	Dostupnost	Šifra artikla	MPC (€) MPC (Kn)
																		
Ⓛ																		
986241																		
765,01 5.763,95																		
																		
Ⓛ																		
480009																		
111,10 837,10																		
																		
Ⓛ																		
585121																		
19,04 143,48																		
Boja																		
Dostupnost																		
Šifra artikla																		
MPC (€) MPC (Kn)																		
 <table border="1" data-bbox="451 1732 578 1930"> <tr><td></td></tr> <tr><td>Ⓛ</td></tr> <tr><td>480138</td></tr> <tr><td>41,26 310,90</td></tr> </table> <p>Pileta</p> <p>Push-open pileta za umivaonik, crna mat.</p>		Ⓛ	480138	41,26 310,90	 <table border="1" data-bbox="880 1732 997 1930"> <tr><td></td></tr> <tr><td>Ⓛ</td></tr> <tr><td>578882</td></tr> <tr><td>74,48 561,15</td></tr> </table> <p>Sifon</p> <p>Sifon za umivaonik, crni mat.</p>		Ⓛ	578882	74,48 561,15	 <table border="1" data-bbox="1306 1732 1423 1930"> <tr><td></td></tr> <tr><td>Ⓛ</td></tr> <tr><td>585126</td></tr> <tr><td>75,01 565,14</td></tr> </table> <p>Ventil</p> <p>Kutni ventil s filterom, crni mat.</p> <table border="1" data-bbox="1441 1732 1628 1930"> <tr><td>Boja</td></tr> <tr><td>Dostupnost</td></tr> <tr><td>Šifra artikla</td></tr> <tr><td>MPC (€) MPC (Kn)</td></tr> </table>		Ⓛ	585126	75,01 565,14	Boja	Dostupnost	Šifra artikla	MPC (€) MPC (Kn)
																		
Ⓛ																		
480138																		
41,26 310,90																		
																		
Ⓛ																		
578882																		
74,48 561,15																		
																		
Ⓛ																		
585126																		
75,01 565,14																		
Boja																		
Dostupnost																		
Šifra artikla																		
MPC (€) MPC (Kn)																		

IDEAL STANDARD **CERALINE**











Ideal Standard nudi jednostavnost dizajna koji je popraćen s funkcionalnošću proizvoda. Standardna linija zadovoljava osnovna očekivanja.

Vrlo jednostavno rješenje za kupaonicu koja se vodi tradicionalnim obilježjima.



IDEAL STANDARD CERALINE



 <table border="1" data-bbox="451 366 584 590"> <tr><td>●</td></tr> <tr><td>Ⓛ</td></tr> <tr><td>604007</td></tr> <tr><td>71,34 537,49</td></tr> </table> <p>Ceraline</p> <p>Miješalica za umivaonik s piletom i podizačem, krom.</p>	●	Ⓛ	604007	71,34 537,49	 <table border="1" data-bbox="875 366 1011 590"> <tr><td>●</td></tr> <tr><td>Ⓛ</td></tr> <tr><td>604010</td></tr> <tr><td>97,10 731,61</td></tr> </table> <p>Ceraline</p> <p>Miješalica za umivaonik, produžena, s piletom i podizačem krom.</p>	●	Ⓛ	604010	97,10 731,61	 <table border="1" data-bbox="1294 366 1439 590"> <tr><td>●</td></tr> <tr><td>Ⓛ</td></tr> <tr><td>604012</td></tr> <tr><td>129,85 978,39</td></tr> </table> <p>Ceraline</p> <p>Zidna miješalica za umivaonik s izljevom 18 cm, krom.</p>	●	Ⓛ	604012	129,85 978,39	<table border="1"> <tr><td>Boja</td></tr> <tr><td>Dostupnost</td></tr> <tr><td>Šifra artikla</td></tr> <tr><td>MPC (€) MPC (Kn)</td></tr> </table>	Boja	Dostupnost	Šifra artikla	MPC (€) MPC (Kn)
●																			
Ⓛ																			
604007																			
71,34 537,49																			
●																			
Ⓛ																			
604010																			
97,10 731,61																			
●																			
Ⓛ																			
604012																			
129,85 978,39																			
Boja																			
Dostupnost																			
Šifra artikla																			
MPC (€) MPC (Kn)																			
 <table border="1" data-bbox="451 802 584 1025"> <tr><td>●</td></tr> <tr><td>Ⓛ</td></tr> <tr><td>604013</td></tr> <tr><td>71,03 535,16</td></tr> </table> <p>Ceraline</p> <p>Miješalica za bide s piletom i podizačem, krom.</p>	●	Ⓛ	604013	71,03 535,16	 <table border="1" data-bbox="875 802 1011 1025"> <tr><td>●</td></tr> <tr><td>Ⓛ</td></tr> <tr><td>604014</td></tr> <tr><td>77,56 584,41</td></tr> </table> <p>Ceraline</p> <p>Miješalica za tuš, krom.</p>	●	Ⓛ	604014	77,56 584,41	 <table border="1" data-bbox="1294 802 1439 1025"> <tr><td>●</td></tr> <tr><td>Ⓛ</td></tr> <tr><td>604018</td></tr> <tr><td>90,09 678,80</td></tr> </table> <p>Ceraline</p> <p>Miješalica za tuš ili kadu s prebacivačem i podžbuknim tijelom, krom.</p>	●	Ⓛ	604018	90,09 678,80	<table border="1"> <tr><td>Boja</td></tr> <tr><td>Dostupnost</td></tr> <tr><td>Šifra artikla</td></tr> <tr><td>MPC (€) MPC (Kn)</td></tr> </table>	Boja	Dostupnost	Šifra artikla	MPC (€) MPC (Kn)
●																			
Ⓛ																			
604013																			
71,03 535,16																			
●																			
Ⓛ																			
604014																			
77,56 584,41																			
●																			
Ⓛ																			
604018																			
90,09 678,80																			
Boja																			
Dostupnost																			
Šifra artikla																			
MPC (€) MPC (Kn)																			
 <table border="1" data-bbox="451 1230 584 1454"> <tr><td>●</td></tr> <tr><td>Ⓛ</td></tr> <tr><td>447614</td></tr> <tr><td>30,22 227,66</td></tr> </table> <p>Idealrain</p> <p>Tuš ručka s tuš crijevom 175 cm i držačem za tuš.</p>	●	Ⓛ	447614	30,22 227,66	 <table border="1" data-bbox="875 1230 1011 1454"> <tr><td>●</td></tr> <tr><td>Ⓛ</td></tr> <tr><td>447611</td></tr> <tr><td>51,37 387,01</td></tr> </table> <p>Idealrain</p> <p>Tuš konzola 60.3 cm s tuš ručkom i tuš crijevom 175 cm, krom.</p>	●	Ⓛ	447611	51,37 387,01	 <table border="1" data-bbox="1294 1230 1439 1454"> <tr><td>●</td></tr> <tr><td>Ⓛ</td></tr> <tr><td>345068</td></tr> <tr><td>111,78 842,19</td></tr> </table> <p>Idealrain Luxe</p> <p>Nadglavna okrugla tuš ruža, Ø 20 cm, krom.</p>	●	Ⓛ	345068	111,78 842,19	<table border="1"> <tr><td>Boja</td></tr> <tr><td>Dostupnost</td></tr> <tr><td>Šifra artikla</td></tr> <tr><td>MPC (€) MPC (Kn)</td></tr> </table>	Boja	Dostupnost	Šifra artikla	MPC (€) MPC (Kn)
●																			
Ⓛ																			
447614																			
30,22 227,66																			
●																			
Ⓛ																			
447611																			
51,37 387,01																			
●																			
Ⓛ																			
345068																			
111,78 842,19																			
Boja																			
Dostupnost																			
Šifra artikla																			
MPC (€) MPC (Kn)																			
 <table border="1" data-bbox="451 1649 584 1834"> <tr><td>●</td></tr> <tr><td>Ⓛ</td></tr> <tr><td>275769</td></tr> <tr><td>45,34 341,59</td></tr> </table> <p>Idealrain</p> <p>Zidni izljev tuš ruže dužine 40 cm, krom.</p>	●	Ⓛ	275769	45,34 341,59	 <table border="1" data-bbox="875 1649 1011 1834"> <tr><td>●</td></tr> <tr><td>Ⓛ</td></tr> <tr><td>321055</td></tr> <tr><td>97,06 731,33</td></tr> </table> <p>Podžbukni element</p> <p>Podžbukni dio zidne miješalice za umivaonik.</p>	●	Ⓛ	321055	97,06 731,33	<table border="1"> <tr><td>Boja</td></tr> <tr><td>Dostupnost</td></tr> <tr><td>Šifra artikla</td></tr> <tr><td>MPC (€) MPC (Kn)</td></tr> </table>	Boja	Dostupnost	Šifra artikla	MPC (€) MPC (Kn)	<table border="1"> <tr><td>Boja</td></tr> <tr><td>Dostupnost</td></tr> <tr><td>Šifra artikla</td></tr> <tr><td>MPC (€) MPC (Kn)</td></tr> </table>	Boja	Dostupnost	Šifra artikla	MPC (€) MPC (Kn)
●																			
Ⓛ																			
275769																			
45,34 341,59																			
●																			
Ⓛ																			
321055																			
97,06 731,33																			
Boja																			
Dostupnost																			
Šifra artikla																			
MPC (€) MPC (Kn)																			
Boja																			
Dostupnost																			
Šifra artikla																			
MPC (€) MPC (Kn)																			

AXOR



AXOR Citterio

AXOR u suradnji sa svjetski poznatim arhitektima i dizajnerima osmišljava te proizvodi predmete namijenjene luksuznim kupaonicama koje iskustvo tuširanja ili umivanja pretvaraju u poseban ritual.

U širokom rasponu stilova za umivaonik, kadu te tuševe, AXOR donosi niz perfektnih, dizajnerskih proizvoda kojima teže ka savršenstvu. Mogućnost biranja proteže se u rasponu od petnaest dizajnerskih boja među kojima se teško odlučiti za onu najljepšu.

Pažnja je posvećena svakom detalju, a proizvodi uspijevaju impresionirati čak i one s najistančanijim ukusom. Dosljedno i pouzdano građenje imidža AXOR je učinilo jednim od vodećih na tržištu luksuznih proizvoda za kupaonice.



AXOR Starck Organic



AXOR One



AXOR Citterio

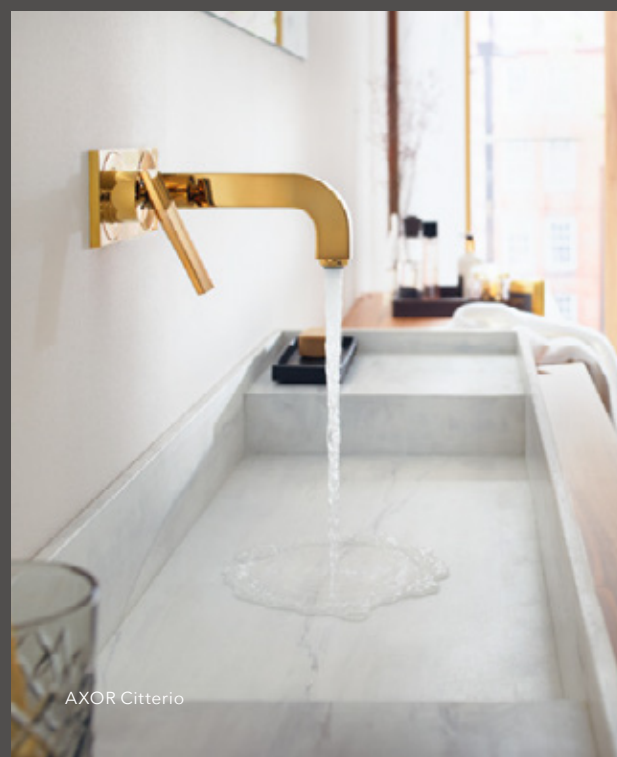

AXOR Citterio

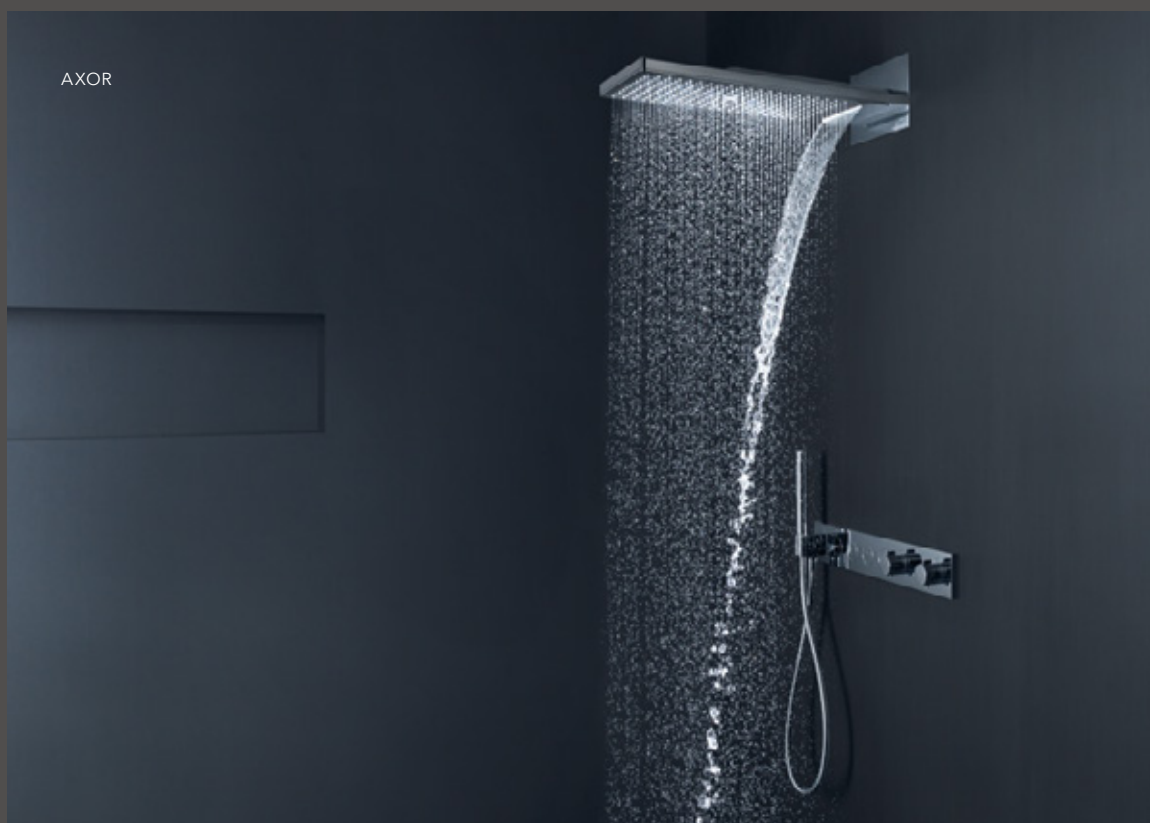

AXOR

GESSI



Stvorite novi, luksuzan svijet u vašoj kupaonici uz GESSI koji vas potiče na fantastično i nesvakidašnje.

Talijanski sinonim za stil i eleganciju nudi proizvode za opremanje kupaonice i wellnesa, a svoju inspiraciju za dizajn crpi u prirodi i povijesti što svjedoči tomu da ovi proizvodi jednostavno ne mogu izaći iz mode. U ponudi se pronalaze proizvodi raznih oblika, pregršt boja te obrada.

Geometrija, čistoća oblika i sklad, ono su što GESSI čini posebnim. Unesite nov, moderan duh vašem prostoru te zamijenite tradicionalan izgled kupaonice. Pokažite svoju individualnost i snažan stil. Harmonija koja stvara funkcionalne skulpture u vašoj kupaonici!



GESSI 316



GESSI Goccia



GESSI Venti20



Gessi 316



GESSI Hi-Fi



GESSI Anello

HANSGROHE

KUHINJSKE MIJEŠALICE I SUDOPERI





HANSGROHE Talis M54 | kuhinjska miješalica s izljevom za izvlačenje | krom | 

Hansgrohe kuhinjske miješalice nude velik izbor dizajna i boja prilikom odabira. Ovisno o tome kakvu vrstu miješalice odaberete, možete birati i sudopere za svoju kuhinju. Sudoperi, osim što su izuzetno praktični i kvalitetni, dolaze u vrlo lijepim bojama koje ćete lagano ukomponirati u dizajn vaše kuhinje.











Bilo da se radi o vintage ili modernoj varijanti, Hansgrohe pruža sve.

HANSGROHE KUHINJSKE MIJEŠALICE I SUDOPERI

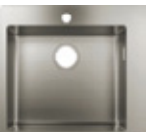
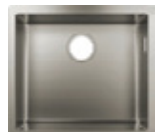

	<input type="radio"/>		<input type="radio"/>		<input type="radio"/>	Boja
	<input type="radio"/>		<input type="radio"/>		<input type="radio"/>	Dostupnost
	212247		212246		359413	Šifra artikla
	123,42 929,94		142,10 1.070,65		265,52 2.000,59	MPC (€) MPC (Kn)
Focus M41		Focus M41		Focus M41		
Kuhinjska miješalica, krom.		Kuhinjska miješalica za protočni bojler, krom.		Kuhinjska miješalica 240 s izljevom za izvlačenje, 2 mlaza, krom.		

HANSGROHE KUHINJSKE MIJEŠALICE I SUDOPERI

 <p>Talis M54 Kuhinjska miješalica 270, krom.</p>	 <p>Talis M54 Kuhinjska miješalica 210 s izljevom za izvlačenje, 2 mlaza, krom.</p>	 <p>Talis M54 Kuhinjska miješalica 210 s izljevom za izvlačenje, 2 mlaza, crna mat.</p>	<p>Boja</p> <p>Dostupnost</p> <p>Šifra artikla</p> <p>MPC (€) MPC (Kn)</p>
 <p>Talis M51 Kuhinjska miješalica 260, krom.</p>	 <p>Aquano Select M81 Kuhinjska miješalica 250 s izljevom za izvlačenje, 2 mlaza, sBox, krom.</p>	 <p>Aquano Select M81 Kuhinjska miješalica 170 s izljevom za izvlačenje, 3 mlaza, sBox, krom.</p>	<p>Boja</p> <p>Dostupnost</p> <p>Šifra artikla</p> <p>MPC (€) MPC (Kn)</p>
 <p>S711 Sudoper za ugradnju na radnu ploču, 55x50 cm, nehrđajući čelik. Sudoperi su dostupni i u drugim dimenzijama.</p>	 <p>S719 Sudoper za ugradnju pod radnu ploču, 55x45 cm, nehrđajući čelik. Sudoperi su dostupni i u drugim dimenzijama.</p>	 <p>S510 Sudoper za ugradnju pod radnu ploču, 71x45 cm, SilicaTec, Graphiteblack. Sudoperi su dostupni i u drugim dimenzijama.</p>	<p>Boja</p> <p>Dostupnost</p> <p>Šifra artikla</p> <p>MPC (€) MPC (Kn)</p>
 <p>S514 Sudoper za ugradnju na radnu ploču s površinom za cijedenje, 105x41.5 cm, SilicaTec, Graphiteblack. Sudoperi su dostupni i u drugim dimenzijama.</p>	 <p>F16 Daska za rezanje, boja orah.</p>	 <p>F14 Multifunkcionalno cjedilo, crno mat.</p>	<p>Boja</p> <p>Dostupnost</p> <p>Šifra artikla</p> <p>MPC (€) MPC (Kn)</p>

PAFFONI KUHINJSKE MIJEŠALICE

Paffoni kuhinjske miješalice zadovoljavaju najviše standarde u dizajnu i kvaliteti. Velik izbor prilikom odabira te mnogo različitih dimenzija i boja mogu olakšati vaš odabir te vas inspirirati ka otkrivanju novih stilova uređenja.

Naš lager sastoji se od popularnih modela miješalica gdje je odabir u rasponu od najjednostavnijeg dizajna do onog koji iskače pored drugih.



PAFFONI Melissa | kuhinjska miješalica | brončana | 

PAFFONI KUHINJSKE MIJEŠALICE



●
Ⓛ
034834
80,62 607,44

Iris
Dvoručna kuhinjska miješalica, krom.



●
Ⓛ
311276
70,45 530,83

Red
Kuhinjska miješalica, krom.



●
Ⓛ
286479
66,64 502,10
MPC (€) MPC (Kn)

Blu
Kuhinjska miješalica, krom.

Boja
Dostupnost
Šifra artikla
MPC (€) MPC (Kn)



●
Ⓛ
479662
81,17 611,59

Green
Kuhinjska miješalica, krom.



●
Ⓛ
033886
77,72 585,57

Denver
Kuhinjska miješalica, krom.



●
Ⓛ
035456
93,12 701,60
MPC (€) MPC (Kn)

Nettuno
Kuhinjska miješalica, krom.

Boja
Dostupnost
Šifra artikla
MPC (€) MPC (Kn)



●
Ⓛ
311277
108,12 814,60

Red
Kuhinjska miješalica s izljevom za izvlačenje, krom.



●
Ⓛ
128427
148,60 1.119,59

Stick
Kuhinjska miješalica, krom.



● ●
Ⓛ
311365
183,40 1.381,82
MPC (€) MPC (Kn)

Ringo
Kuhinjska miješalica s izljevom za izvlačenje, crna mat.

Boja
Dostupnost
Šifra artikla
MPC (€) MPC (Kn)



●
Ⓛ
117991
373,41 2.813,43

Melissa
Kuhinjska miješalica, brončana.



●
Ⓛ
117025
417,53 3.145,88

Belinda
Dvoručna kuhinjska miješalica, brončana.

Boja
Dostupnost
Šifra artikla
MPC (€) MPC (Kn)



UNIVERZALNO



●
Ⓛ
113469
30,46
229,50

Catalano

Push-open pileta za umivaonik bez preljeva, krom.



●
Ⓛ
104607
39,34
296,38

Catalano

Push-open pileta za umivaonik ili bide s preljevom, krom.



○ ○ ●
Ⓛ
605941
48,21
363,25

Catalano

Push-open pileta za umivaonik bez preljeva, bijela sjajna.

Boja

Dostupnost

Šifra artikla

MPC (€)
MPC (Kn)

●
Ⓛ
103387
30,99
233,49

Remer

Push-open pileta za umivaonik bez preljeva, krom



●
Ⓛ
103388
31,30
233,49

Remer

Push-open pileta za umivaonik s preljevom, krom



●
Ⓛ
113584
38,82
292,52

Geberit

Sifon za umivaonik, krom.

Boja

Dostupnost

Šifra artikla

MPC (€)
MPC (Kn)

●
Ⓛ
118652
20,36
153,38

Remer

Sifon za umivaonik, krom.

Boja

Dostupnost

Šifra artikla

MPC (€)
MPC (Kn)



RASPOLOŽIVE BOJE I ZAVRŠNE OBRADJE

● Krom

● Zlatna

● Četkana crna

● Inox

● Četkana brončana

○ Crna mat

● Bijela mat



GALANTERIJA

INDA

Inda galanterija, osim što je nevjerovatno pametno osmišljena, jednako je i lijepa.

















Galanterija iz Inde zaista je ukras u vašem prostoru. Sve je izrađeno od iznimno kvalitetnih materijala, pa je tako i dugotrajnost zagarantirana. Materijali su otporni na uvjete u kupaonicama a to su vlažnost zraka, kemikalije, te izlaganje UV zračenju.

Važno je napomenuti kako Inda prati trendove u svijetu dizajna, no njezini su proizvodi bezvremenski klasici koji će kroz godine izgledati jednako dobro. Kako bi lakše kombinirali galanteriju uz ostatak svoje kupaonice, Inda se pobrinula za to da omogući velik izbor boja svojih proizvoda.



INDA LEA



						Dimenzije (cm)
						Boja
Lea Čaša od satiniranog stakla, krom.	458849	Lea Dozator za tekući sapun od satiniranog stakla, krom.	458855	Lea Dozator za tekući sapun od satiniranog stakla, krom.	833296	Dostupnost
	33,21 250,25		57,27 431,51		53,93 406,34	Šifra artikla
	30					Dimenzije (cm)
						Boja
Lea Držač ručnika, krom. Na lageru dostupne i dimenzije 45 cm, 60 cm.	113091	Lea Držač wc papira, krom.	458862	Lea Zidna wc četka s posudom od satiniranog stakla, krom.	458857	Dostupnost
	55,60 418,95		34,91 263,02		67,70 510,08	Šifra artikla
						MPC (€) MPC (Kn)



















INDA MITO



						Dimenzije (cm)
						Boja
Mito Čaša od satiniranog stakla, krom.	303674	Mito Dozator za tekući sapun od satiniranog stakla, krom.	992557	Mito Dozator za tekući sapun od satiniranog stakla, krom.	992587	Dostupnost
	41,92 315,85		92,43 696,45		73,95 557,16	Šifra artikla
						MPC (€) MPC (Kn)
	30					Dimenzije (cm)
						Boja
Mito Držač ručnika, krom. Na lageru dostupne i dimenzije 45 cm, 60 cm.	303690	Mito Držač wc papira, desni, krom. Na lageru dostupan i lijevi.	303695	Mito Podna/zidna wc četka, krom.	210009	Dostupnost
	53,51 403,15		41,92 315,85		68,34 514,87	Šifra artikla
						MPC (€) MPC (Kn)



















INDA DIVO



					30	Dimenzije (cm)
						Boja
	992500		992508			Dostupnost
	60,94 459,17		85,88 647,02		220289	Šifra artikla
Divo		Divo		Divo		MPC (€) MPC (Kn)
Čaša od satiniranog stakla, krom.		Dozator za tekući sapun od satiniranog stakla, krom.		Držač ručnika, krom. Na lageru dostupne i dimenzije 45 cm, 60 cm.		
						Dimenzije (cm)
						Boja
	303655		220287			Dostupnost
	79,20 596,74		24,17 182,10		303755	Šifra artikla
Divo		Divo		Divo		MPC (€) MPC (Kn)
Držač wc papira, krom.		Jednostruka vješalica, krom.		Podna/zidna wc četka, krom.		

INDA LEA



						Dimenzije (cm)
						Boja
	555440		555494			Dostupnost
	38,19 287,76		65,83 495,96		833361	Šifra artikla
Lea		Lea		Lea		MPC (€) MPC (Kn)
Čaša od satiniranog stakla, crna mat.		Dozator za tekući sapun od satiniranog stakla, crni mat.		Dozator za tekući sapun od satiniranog stakla, crni mat.		
	30					Dimenzije (cm)
						Boja
						Dostupnost
	555530		555620		992521	Šifra artikla
Lea		Lea		Lea		MPC (€) MPC (Kn)
Držač ručnika, crni mat. Na lageru dostupne i dimenzije 45 cm, 60 cm.		Držač wc papira, crni mat.		Zidna wc četka s posudom od satiniranog stakla, crna mat.		
	64,65 487,10		40,06 301,80		78,86 594,19	

INDA ONE





555920
58,40 440,02

One

Čaša s prozirnim staklom, crna mat.







555934
74,29 559,72

One

Dozator za tekući sapun s prozirnim staklom, crni mat.



30	Dimenzije (cm)
	Boja
	Dostupnost
555990	Šifra artikla
38,45 289,67	MPC (€) MPC (Kn)

One

Držać ručnika, crni mat. Na lageru dostupne i dimenzije 45 cm, 60 cm.







555962
51,64 389,10

One

Držać wc papira, crni mat.







556025
24,02 180,99

One

Jednostruka vješalica, crna mat.



	Dimenzije (cm)
	Boja
	Dostupnost
493281	Šifra artikla
79,58 599,61	MPC (€) MPC (Kn)

One

Podna/zidna wc četka, crna mat.



INDA One galanterija | 



INDA Lea galanterija

INDA

	<p>Ø 20</p> <p>●</p> <p>⌚</p> <p>220438</p> <p>79,82 601,37</p>		<p>○</p> <p>⌚</p> <p>220436</p> <p>95,30 718,04</p>		<p>Dimenzije (cm)</p> <p>○</p> <p>Boja</p> <p>⌚</p> <p>Dostupnost</p> <p>062734</p> <p>Šifra artikla</p> <p>72,61 547,11</p> <p>MPC (€) MPC (Kn)</p>
<p>Hotellerie</p>	<p>Okruglo ogledalo s povećalom, krom.</p>	<p>Hotellerie</p>	<p>Sušilo za kosu sa sigurnosnim termostatom, bijelo/krom.</p>	<p>Hotellerie</p>	<p>Sušilo za kosu sa sigurnosnim termostatom, bijelo.</p>
	<p>●</p> <p>⌚</p> <p>211615</p> <p>143,15 1.078,58</p>		<p>●</p> <p>⌚</p> <p>273887</p> <p>23,02 173,48</p>		<p>Dimenzije (cm)</p> <p>●</p> <p>Boja</p> <p>Dostupnost</p> <p>833307</p> <p>Šifra artikla</p> <p>166,21 1.252,31</p> <p>MPC (€) MPC (Kn)</p>
<p>Hotellerie</p>	<p>Sušilo za ruke, krom.</p>	<p>Hotellerie</p>	<p>Kanta za otpatke, 3 litre, inox. Na lageru dostupna i u varijanti od 5 litara.</p>	<p>Hotellerie</p>	<p>Samostojeći držač ručnika, crni mat.</p>

GEESA

NEMOX























Nemox kolekcija u crnoj i krom boji iz tvornice Geesa suptilna je i funkcionalna galanterija izrazito lijepog dizajna. Funkcionalnost je bila glavni prioritet te nit vodilja prilikom stvaranja kolekcije, a oblici su takvi da je galanterija univerzalno primjenjiva. Suvišno ne postoji, a manje je više. Kompletan asortiman obuhvaća sve ono što je potrebno u kupaonici te znatno olakšava svakodnevne radnje.





GEESA Nemox galanterija | L

GEESA NEMOX





























					45 cm	Dimenzije (cm)
						
Nemox Čaša s prozirnim staklom, crna mat.		Nemox Dozator za tekući sapun od satiniranog stakla, crni mat.		Nemox Držač ručnika, crni mat.		Dostupnost
	555323		555328		527733	Šifra artikla
68,06	90,49	111,07	MPC (€)			
512,77	681,77	836,85	MPC (Kn)			
					60 cm	Dimenzije (cm)
						Boja
Nemox Jednostruki fiksni držač ručnika, crni mat.		Nemox Držač ručnika s policom, crni mat.		Nemox Držač wc papira, crni mat.		Dostupnost
	859432		859433		527732	Šifra artikla
55,54	150,69	58,86	MPC (€)			
418,43	1.135,35	443,45	MPC (Kn)			

	30 cm		38 cm		Dimenzije (cm)	
						Boja
						Dostupnost
	853946		527735		527731	Šifra artikla
126,54 953,41	14,70 110,79	42,99 323,38	MPC (€) MPC (Kn)			
Nemox Mrežasta košarica, crna mat.	Nemox Jednostruka vješalica, crna mat.	Nemox Podna/zidna wc četka, crna mat.				

GEESA NEMOX



					45 cm	Dimenzije (cm)
						Boja
	272222		360865		449711	Dostupnost
	38,27 288,37		64,71 487,60		89,38 673,47	Šifra artikla
Nemox Čaša s prozirnim staklom, krom.	Nemox Dozator za tekući sapun, krom.	Nemox Držač ručnika, krom.				
	38 cm				30 cm	Dimenzije (cm)
						Boja
						Dostupnost
	487603		283265		449701	Šifra artikla
47,81 360,22	31,69 238,74	110,71 834,18	MPC (€) MPC (Kn)			
Nemox Jednostruki fiksni držač ručnika, krom.	Nemox Držač wc papira, krom.	Nemox Mrežasta košarica, krom.				
					Dimenzije (cm)	
						Boja
	278740		449700		389648	Dostupnost
	7,58 57,08		69,16 521,06		64,36 484,93	Šifra artikla
Nemox Jednostruka vješalica, krom.	Nemox Zidna wc četka, krom.	Nemox Podna wc četka, krom.				

HANSGROHE

Hansgrohe kupaonski pribor unio je nove standarde u dizajn. Moderni, klasični ili avangardni, Hansgrohe nudi sve kako biste mogli ostati dosljedni svojem stilu.

Kvaliteta stanovanja mora biti usavršena do posljednjeg detalja, stoga je galanterija usklađena s bojama miješalica i ostalih Hansgrohe proizvoda. Radi kvalitetnih materijala ovi se proizvodi lako održavaju. S funkcionalnom galanterijom važne stvari uvijek su vam nadohvat ruke.



HANSGROHE AddStoris galanterija

HANSGROHE ADDSTORIS





860164
40,22 303,07

AddStoris
Čaša od satiniranog stakla, krom.



860139
57,00 429,45

AddStoris
Dozator za tekući sapun od satiniranog stakla, krom.



64,8 cm	Dimenzije (cm)
	Boja
	Dostupnost
860151	Šifra artikla
64,96 489,45	MPC (€) MPC (Kn)

AddStoris
Držač ručnika, krom.



860212
64,96 489,45

AddStoris
Dvostruki držač ručnika, krom.



860218
45,44 342,40

AddStoris
Držač wc papira, krom.



	Dimenzije (cm)
	Boja
	Dostupnost
860176	Šifra artikla
57,00 429,45	MPC (€) MPC (Kn)

AddStoris
Zidna wc četka sa staklenom posudom, krom.



HANSGROHE AddStoris galanterija

GEDY

Jednostavna, moderna Gedy galanterija pravi je pomagač u vašoj kupaonici. Funkcionalni proizvodi osmišljeni su da olakšaju svakodnevne radnje, ali i da uljepšaju vaš prostor.

Detalji čine razliku, a Gedy nam to potvrđuje. U nekoliko lagerskih kolekcija možete pronaći baš sve što vam je potrebno u svijetu galanterije.





GEDY Pirenei galanterija |







GEDY EDERA PLUS



	●		●		35	Dimenzije (cm)
	Ⓛ		Ⓛ		●	Boja
497756	497762	497758	27,90 210,19	Dostupnost	Šifra artikla	
20,19 152,10	29,06 218,97	27,90 210,19	MPC (€) MPC (Kn)			
Edera Plus	Edera Plus	Edera Plus				
Čaša od satiniranog stakla, krom.	Dozator za tekući sapun od satiniranog stakla, krom.	Držač ručnika, 35 cm, krom. Na lageru dostupne i dimenzije 45 cm i 60 cm.				
				●	Dimenzije (cm)	
			Ⓛ	●	Boja	
497759	493455	258117	34,47 259,67	Dostupnost	Šifra artikla	
36,10 271,96	23,51 177,16	34,47 259,67	MPC (€) MPC (Kn)			
Edera Plus	Edera Plus	Edera Plus				
Dvostruki pomični držač ručnika, krom.	Držač wc papira, krom.	Zidna wc četka, krom.				







GEDY PIRENEI



	●		●		45 cm	Dimenzije (cm)
	Ⓛ		Ⓛ		Boja	
426431		426433		426434		Dostupnost
23,24 175,08		32,03 241,32		46,26 348,57		Šifra artikla
Pirenei		Pirenei		Pirenei		MPC (€) MPC (Kn)
Čaša od satiniranog stakla, krom.		Dozator za tekući sapun od satiniranog stakla, krom.		Držač ručnika, 45 cm, krom. Na lageru dostupna i dimenzija 60 cm.		
	●		●			Dimenzije (cm)
	Ⓛ		Ⓛ		Boja	
426436		426438		426440		Dostupnost
47,34 356,71		23,28 175,40		40,78 307,23		Šifra artikla
Pirenei		Pirenei		Pirenei		MPC (€) MPC (Kn)
Dvostruki pomični držač ručnika, krom.		Držač wc papira, krom.		Zidna wc četka sa staklenom posudom, krom.		

GEDY PIRENEI



	●		●		45 cm	Dimenzije (cm)
	Ⓛ		Ⓛ		Boja	
858588		858594		858589		Dostupnost
23,64 178,11		31,82 239,72		45,56 343,30		Šifra artikla
Pirenei		Pirenei		Pirenei		MPC (€) MPC (Kn)
Čaša od satiniranog stakla, crna mat.		Dozator za tekući sapun od satiniranog stakla, crni mat.		Držač ručnika, 45 cm, crni mat. Na lageru dostupna i dimenzija 60 cm.		
	●		●			Dimenzije (cm)
	Ⓛ		Ⓛ		Boja	
858591		604536		858592		Dostupnost
42,85 322,87		23,15 174,44		38,55 290,47		Šifra artikla
Pirenei		Pirenei		Pirenei		MPC (€) MPC (Kn)
Dvostruki pomični držač ručnika, crni mat.		Držač wc papira, crni mat.		Zidna wc četka sa staklenom posudom, crna mat.		

GEDY

	<input type="radio"/> <input checked="" type="radio"/> 578377 51,92 391,18		<input type="radio"/> <input checked="" type="radio"/> 578378 51,92 391,18		<input checked="" type="radio"/> <input type="radio"/> 853811 55,33 416,88	Dimenzije (cm) Boja Dostupnost Šifra artikla MPC (€) MPC (Kn)
Trilly Samostojeći držač ručnika, krom.		Trilly Samostojeći stalak s držačem wc papira i wc četkom, krom.		Trilly Samostojeći držač ručnika, crni mat.		
	<input checked="" type="radio"/> <input type="radio"/> 853813 55,33 416,88		<input type="radio"/> <input checked="" type="radio"/> 245165 106,10 799,44		<input type="radio"/> <input checked="" type="radio"/> 245166 106,10 799,44	Dimenzije (cm) Boja Dostupnost Šifra artikla MPC (€) MPC (Kn)
Trilly Samostojeći stalak s držačem wc papira i wc četkom, crni mat.		Maine Samostojeći držač ručnika, krom.		Maine Samostojeći stalak s držačem wc papira i wc četkom, krom.		
	<input checked="" type="radio"/> <input type="radio"/> 858595 123,66 931,74		<input checked="" type="radio"/> <input type="radio"/> 847697 115,85 872,85		<input type="radio"/> <input checked="" type="radio"/> 219245 111,76 842,05	Dimenzije (cm) Boja Dostupnost Šifra artikla MPC (€) MPC (Kn)
Florida Samostojeći držač ručnika, crni mat.		Florida Samostojeći stalak s držačem wc papira i wc četkom, crni mat.		Mrežasta košarica Dupla mrežasta košarica za vješanje na tuš kabinu, krom.		
	<input checked="" type="radio"/> <input type="radio"/> 858604 24,59 185,30		<input type="radio"/> <input checked="" type="radio"/> 426439 15,61 117,59		<input checked="" type="radio"/> <input type="radio"/> 604535 17,54 132,15	Dimenzije (cm) Boja Dostupnost Šifra artikla MPC (€) MPC (Kn)
Potty Kanta za smeće, 3 litre, crna mat.		Pirenei Zidna vješalica (2 kom), krom.		Pirenei Zidna vješalica (2 kom), crna mat.		



KADE
-
TUŠ KADE
-
KANALICE
-
TUŠ KABINE

BETTE

BETTEULTRA



BetteUltra tuš kada 1 





BetteUltra tuš kade kombiniraju raznolikost, praktičnost i lijep dizajn. Ove tuš kade možete pronaći u 60 različitih dimenzija te 22 boje. Visinom od samo 2,5 cm ili 3,5 cm BetteUltra uklapa se u svaki dizajn kupaonice te se može postaviti u razini poda, gotovo u razini poda ili podignuto iznad poda. Mogućnost da je pileta u istoj boji kao i tuš kada, podiže estetiku na još višu razinu.

Načinjene od titana i čelika, gotovo su neuništive pa su tako otporne na kemikalije, visoke temperature, udarce, ogrebotine. Ne prenose zvuk te apsorbiraju toplinu vode tako da za čas postaju ugodne pod nogama. Njihov BetteGlaze premaz čini ih i higijenski najboljom opcijom jer ne postoje pore u kojima se mogu stvarati nečistoće.



BetteUltra

Čelična tuš kada s integriranim T1 stiroporom za ugradnju, bijela.

Dimenzije (cm)	MPC (€)	MPC (Kn)	Šifra artikla	Dostupnost
80x80xh2,5cm	504,51	3.801,06	577804	
90x90xh2,5cm	302,94	2.282,50	859304	
100x80xh2,5cm	343,04	2.584,60	859305	
100x90xh2,5cm	571,27	4.304,09	1062867	
100x100xh2,5cm	571,27	4.304,26	1117414	
120x80xh3,5cm	383,58	2.890,08	859306	
120x90xh3,5cm	383,58	2.890,08	859307	
130x80xh3,5cm	687,01	5.176,29	1062869	
130x90xh3,5cm	687,01	5.176,29	1062870	
140x80xh3,5cm	687,01	5.176,29	1062871	
140x90xh3,5cm	412,47	3.107,78	859308	
150x90xh3,5cm	711,49	5.360,88	1062872	
160x90xh3,5cm	711,49	5.360,88	1062873	

BETTE

BETTEFLOOR



BetteFloor | BetteFloor Side tuš kada

BetteFloor može se pohvaliti impresivnim dizajnom, bez da privlači pozornost. Završna obrada ove kolekcije osigurava optimalnu higijenu jer na površini nema pora u kojima se inače sakupljaju nečistoće. Rađene su od gotovo neuništivih materijala: titana i čelika.

BetteFloor je dostupan u velikom izboru veličina, u rasponu od malih, standardnih dimenzija do tuš kadi izdašne veličine. Osim toga, može se dobiti u čak 22 ekskluzivne boje. Moguće je i da sifon bude usklađen s bilo kojom bojom, buka prilikom tuširanja također je reducirana. Postoji i mogućnost biranja između BetteAnti-Slipa, BetteAnti-Slipa Pro i BetteAnti-Slipa Sense. Tuš kade BetteFloor mogu biti ugrađene u razini poda ili mogu biti postavljene na pod.



BetteFloor tuš kada | Ⓛ



BetteFloor

Čelična tuš kada visine 3 cm s integriranim T1 stiroporom za ugradnju, bijela.

Dimenzije (cm)	MPC (€)	MPC (Kn)	Šifra artikla	Dostupnost
90x90	386,78	2.914,18	859299	Ⓛ
100x80	439,48	3.311,24	859300	Ⓛ
100x100	686,26	5.170,65	852390	
120x80	510,07	3.843,16	859301	Ⓛ
120x90	510,07	3.843,16	859302	Ⓛ
130x90	796,81	6.003,56	851573	
140x90	528,46	3.981,67	859303	Ⓛ
150x90	825,00	6.215,98	852218	
160x90	825,00	6.215,98	852605	
170x90	853,94	6.434,03	852820	
180x90	884,36	6.663,18	852734	

BETTE

BETTEFLOOR SIDE



BetteFloor Side tuš kada

BetteFloor Side su tuš kade koje imaju sifon pozicioniran bočno, što je vrlo praktično rješenje prilikom tuširanja - voda se ne zadržava već ubrzano odlazi prema sifonu.

Ponovno, i BetteFloor Side je kolekcija koja je dostupna u mnogo dimenzija te se može dobiti u različitim bojama. Higijenski savršeno rješenje radi glatke površine, a kvalitetom siguran odabir jer su neuništive. Otporne su na visoke temperature, udarce, grebanje, kemikalije, UV zrake. Tome svjedoči i garancija od 30 godina. Radi tri mogućnosti ugradnje, ovaj model zaista je popularan.



BetteFloor Side

Čelična tuš kada visine 3 cm, bijela.

Dimenzije (cm)	MPC (€)	MPC (Kn)	Šifra artikla	Dostupnost
90x90	569,78	4.292,99	331779	
100x80	655,10	4.935,86	577538	
100x90	655,10	4.935,86	577535	
100x100	655,10	4.935,86	577533	
120x80	740,43	5.578,74	331785	
120x90	740,43	5.578,74	331778	
120x100	740,43	5.578,74	331781	
130x90	797,56	6.009,20	577548	
140x80	797,56	6.009,20	577532	
140x90	797,56	6.009,20	577534	
150x90	854,69	6.439,66	577543	
160x90	854,69	6.439,66	577540	
170x90	854,69	6.439,66	577520	
180x90	887,32	6.685,54	577524	
180x100	887,32	6.685,54	577528	

NOVELLINI

OLYMPIC PLUS



NOVELLINI Olympic Plus tuš kada |



Olympic Plus

Akrilna tuš kada visine 4,5 cm, bijela.

Dimenzije (cm)	MPC (€)	MPC (Kn)	Šifra artikla	Dostupnost
120x80	264,78	1.995,00	359915	
120x90	352,16	2.653,35	377643	
140x80	290,20	2.186,52	377674	
140x90	394,53	2.972,55	377682	
160x80	415,71	3.132,15	328766	
180x80	421,00	3.172,05	478399	

Akrilna tuš kada Olympic Plus, kao i sve kolekcije u Novelliniju, dolazi u vrlo širokom rasponu dimenzija. Olympic Plus pojavljuje se u šest boja te se pileta može zatražiti u istoj boji u kojoj je i tuš kada.

Estetika je vrlo bitna komponenta stoga se pazilo na svaki detalj, a kvaliteta tuš kade zadovoljit će sve standarde.

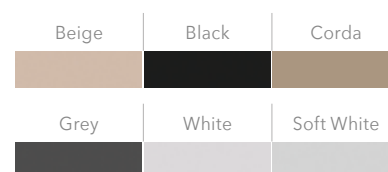

NOVELLINI CUSTOM



NOVELLINI Custom tuš kada |

Novellini Custom izvršna je kolekcija koja pruža opciju rezanja tuš kade ovisno o potrebama. Drugim riječima, ova kolekcija može se prilagoditi zaista svim arhitektonskim potrebama, a pritom neće gubiti na estetici. Štoviše, Custom kolekcija nudi čak šest boja prilikom izbora te se pilete mogu dobiti u istoj boji kako bi bile manje zamjetne.

Custom tuš kade dolaze s pojačanim čeličnim profilima te radi kvalitetne izrade zadovoljavaju sve najviše standarde. Custom se može ugraditi u razini poda ili se postavlja na pod. Uz sve spomenuto, bitno je napomenuti i velike mogućnosti prilikom odabira dimenzija.

Beige	Black
Corda	Grey
White	Soft White



NOVELLINI Custom tuš kada



Custom

Akrilna tuš kada s mogućnošću rezanja, visine 3,5 cm, s anti-slipom, bijela.

Dimenzije (cm)	MPC (€)	MPC (Kn)	Šifra artikla	Dostupnost
120x80	362,22	2.729,16	370434	
120x90	542,81	4.089,75	370440	
140x80	404,59	3.048,36	370452	
140x90	532,21	4.009,95	370458	
160x80	561,34	4.229,40	370464	
180x80	601,06	4.528,65	370476	

NOVELLINI NOVOSOLID





NOVELLINI Novosolid tuš kada | 



Novosolid

Tuš kada od poliesterske smole s mogućnošću rezanja, visine 3,5 cm, bijela.

Dimenzije (cm)	MPC (€)	MPC (Kn)	Šifra artikla	Dostupnost
120x80	508,38	3.830,40	455248	
120x90	544,39	4.101,72	473278	
140x80	691,08	5.206,95	473282	
140x90	595,23	4.484,76	473284	
160x80	781,11	5.885,25	473291	
180x80	839,36	6.324,15	473297	

Novosolid predstavlja novu generaciju tuš kade. Novi dizajn, funkcionalnost i praktičnost samo su neka od odličja kojima se ova kolekcija može pohvaliti. Novosolid tuš kada nudi širok izbor dimenzija, a ako niti unutar tog raspona ne pronađete što tražite, tuš kada se može izrezati po osobnim potrebama kako bi savršeno odgovarala prostoru za koji je namijenjena. Proizvedena je od viokokvalitetnih materijala od čega je čak 75% dolomitni mramor. Izdržljiva je i otporna, a efekt kamena daje mat završni sloj.

Novosolid dolazi u crnoj i bijeloj boji, a sifon ove kolekcije napravljen je od istog materijala te u istoj boji kao i tuš kada. Ova kolekcija nudi tri načina ugradnje: u razini poda, na pod, s oblogom.

Mat White Mat Black

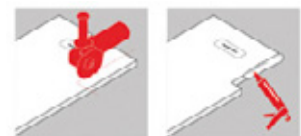

NOVELLINI OLYMPIC / VICTORY



NOVELLINI Olympic tuš kada | 

Olympic i Victory su kolekcije jednostavnog dizajna te će se bez problema uklopiti u svaku kupaonicu te u svaki stil uređenja.



Novellini se pobrinuo da i ove dvije kolekcije dolaze u različitim dimenzijama s namjerom kako bi zadovoljio svačije želje i potrebe. Ukoliko netko ne želi četvrtastu kadu, tu je i nešto drugačiji dizajn.

Beige	Black
Corda	Grey
White	Soft White



Olympic

Akrilna tuš kada visine 4,5 cm, bijela.

Dimenzije (cm)	MPC (€)	MPC (Kn)	Šifra artikla	Dostupnost
80x80	301,85	2.274,30	377791	
90x90	258,43	1.947,12	377793	
100x80	258,43	1.947,12	377789	
100x100	341,57	2.573,55	377785	



Victory

Akrilna polukružna tuš kada visine 4,5 cm, bijela.

Dimenzije (cm)	MPC (€)	MPC (Kn)	Šifra artikla	Dostupnost
80x80	344,22	2.593,50	385400	
90x90	283,85	2.138,64	385402	
100x100	370,69	2.793,00	385398	

GSI / IDEAL STANDARD

GSI tuš kada | 

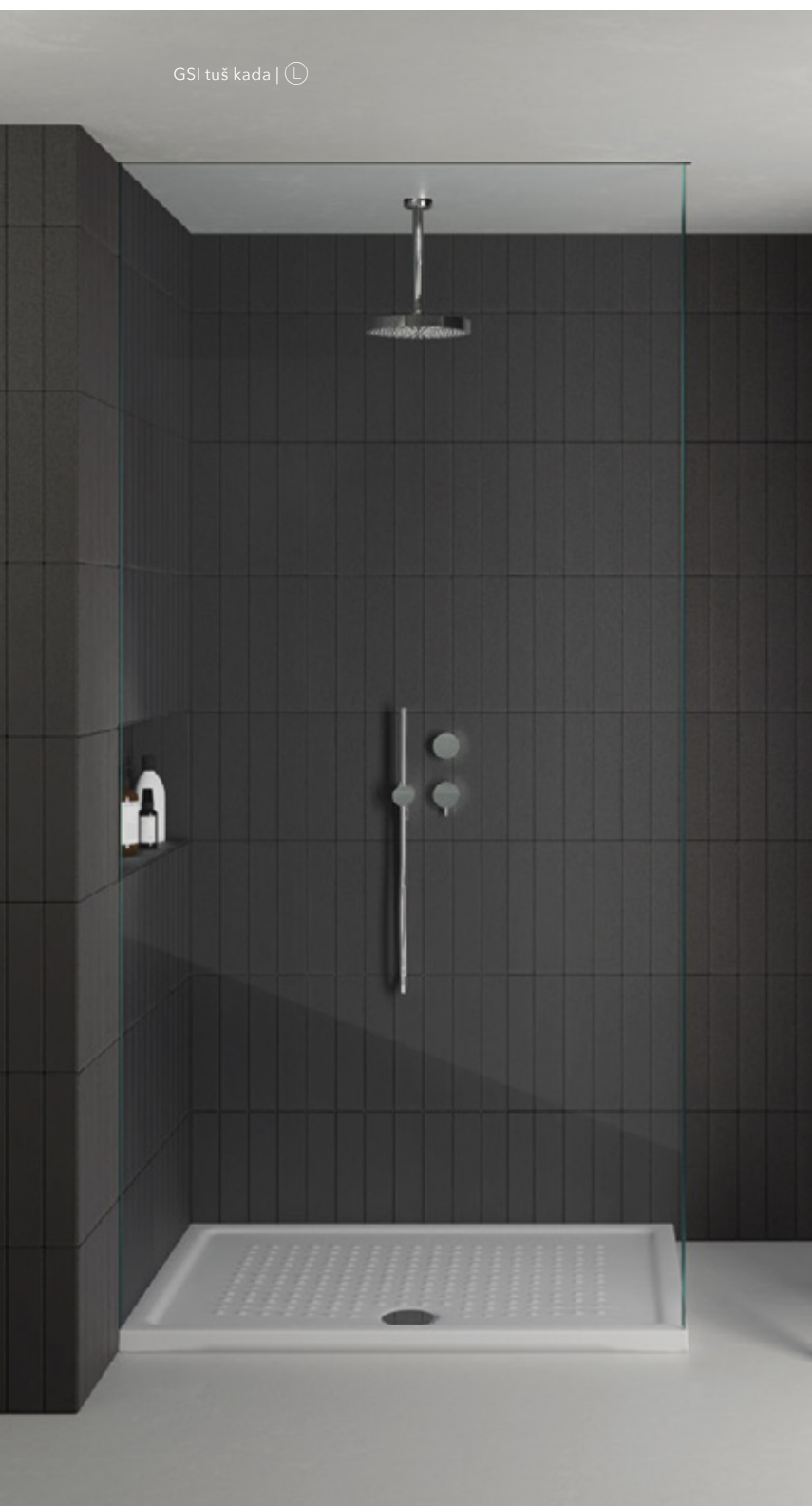





Ideal Standard i GSI poznati su po svojoj kvaliteti i dugotrajnosti. Lijepog, klasičnog dizajna, ove tuš kade bit će najbolji izbor za one koji žele jednostavnost i funkcionalnost. Osim za vlastiti dom, radi visoke kvalitete, ovi proizvodi jednako su popularni i za opremanje hotela, javnih prostora, zdravstvenih ustanova i sportskih objekata.

Elegantne tuš kade dolaze u raznim dimenzijama pa ih se vrlo lako može prilagoditi prostoru. Pouzdana i inovativna rješenja za vašu kupaonicu izrađena su uz pomoć suvremene tehnologije proizvodnje.



GSI

Keramička tuš kada visine 4,5 cm, s anti-slipom, bijela.

Dimenzije (cm)	MPC (€)	MPC (Kn)	Šifra artikla	Dostupnost
80x80	134,40	1.012,63	886471	
90x90	159,45	1.201,35	868284	
100x80	175,33	1.321,02	868283	
120x80	209,54	1.578,78	866876	



Ideal Standard Connect

Keramička tuš kada polukružna, visine 6 cm, s anti-slipom, bijela.

Dimenzije (cm)	MPC (€)	MPC (Kn)	Šifra artikla	Dostupnost
80x80	204,76	1.542,74	299966	
90x90	195,04	1.469,51	299968	

EASY DRAIN



Aqua Compact

Podni sifon, četkani inox.

Dimenzije (cm)	MPC (€)	MPC (Kn)	Šifra artikla	Dostupnost
15x15	31,97	240,90	434246	Ⓛ

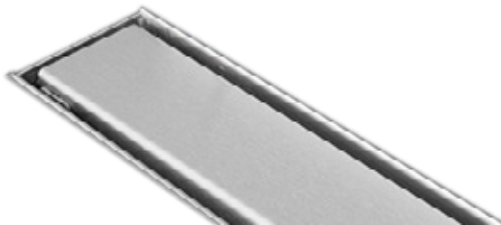

Zero

Tuš kanalica s prirubnicom, četkani inox.

Dimenzije (cm)	MPC (€)	MPC (Kn)	Šifra artikla	Dostupnost
70 cm	108,94	820,80	449575	Ⓛ
80 cm	114,39	861,84	449576	Ⓛ



Basic Drain

Tuš kanalica s integriranom brtvenom hidroizlacijskom manžetom, pokrov može biti četkani inox ili za ugradnju keramičke pločice.

Dimenzije (cm)	MPC (€)	MPC (Kn)	Šifra artikla	Dostupnost
70 cm	225,14	1.696,32	434247	Ⓛ
80 cm	239,67	1.805,76	393562	Ⓛ
90 cm	248,74	1.874,16	434248	Ⓛ

Easy Drain pobrinuo se da tuš kanalica u vašoj kupaonici bude lijepa, decentna i vrlo funkcionalna. Pruža mogućnost postavljanja odvoda uz zid ili slobodno u pod. Postoje različiti modeli za različite vrste podova (keramičke pločice i kamen), a tehnologija Easy Draina garantira najbolje rješenje za svakoga.

Prednost Easy Drain kanalica je njezin Water Protection System (WPS) koji se sastoji od tvornički dvostrano pričvršćene vodonepropusne tkanine na prirubnici tuš kanalice. Pruža siguran i vodonepropustan spoj tuš kanalice s hidroizolacijom čime se uklanja rizik procurivanja koji bi se mogao pojaviti u nepovoljnim uvjetima montaže. Pokrov tuš kanalice može doći i u Special Finishes bojama koje možete uskladiti s ostatkom vaše kupaonice.



EASY DRAIN Waterstop Wall tuš kanalica | Ⓛ

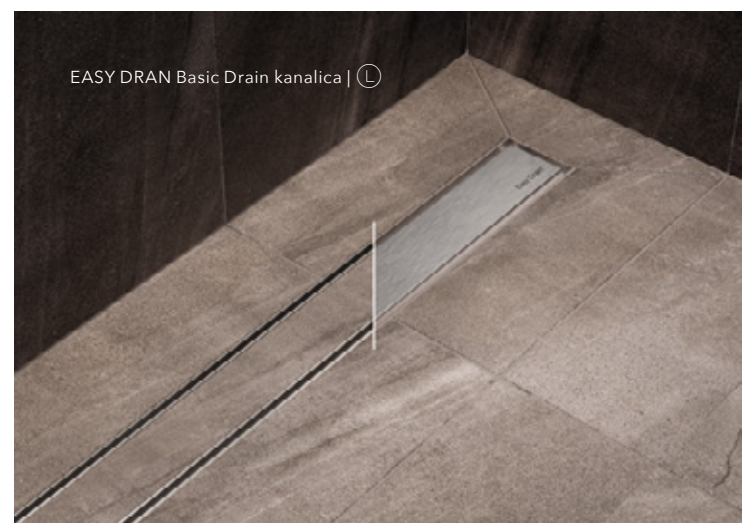

EASY DRAN Basic Drain kanalica | Ⓛ



EASY DRAIN R-Line Wall tuš kanalica | 



R-Line Wall



Tuš kanalica s integriranom hidroizolacijskom folijom dimenzije 130x200 cm, za ugradnju uz zid, četkani inox.

Dimenzije (cm)	MPC (€)	MPC (Kn)	Šifra artikla	Dostupnost
90 cm	175,66	1.323,54	583273	



Waterstop Wall

Tuš kanalica s integriranom hidroizolacijskom folijom dimenzije 150x200 cm, za ugradnju uz zid, s pokrovom za keramičku pločicu.

Dimenzije (cm)	MPC (€)	MPC (Kn)	Šifra artikla	Dostupnost
70 cm	228,77	1.723,68	583675	
80 cm	234,22	1.764,72	583676	
90 cm	237,85	1.792,08	583677	

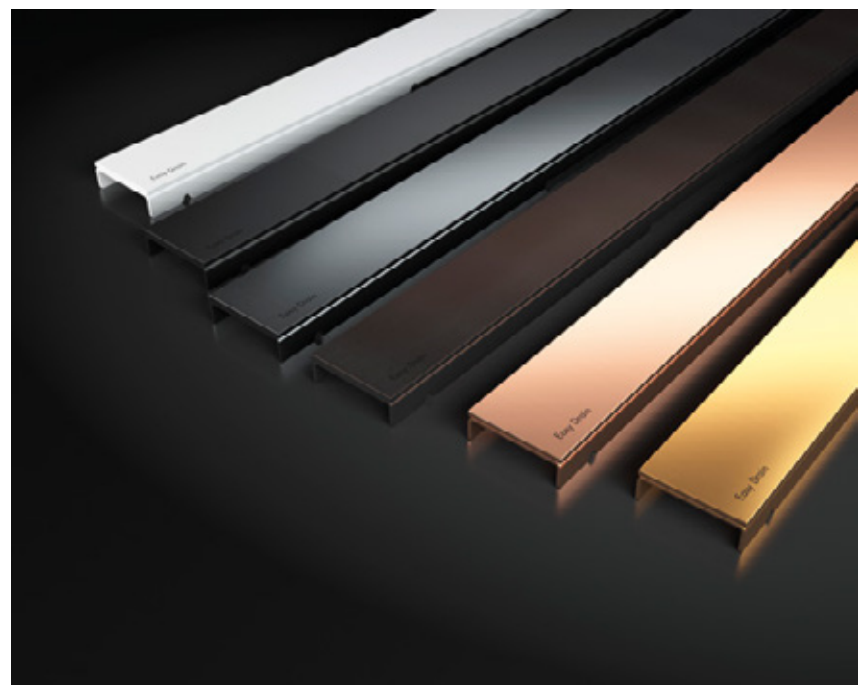

GEBERIT



Cleanline20

Tuš kanalice s mogućnošću prilagodbe po visini i nagibu te s mogućnošću skraćivanja, tamni rub/četkani inox.

Dimenzije (cm)	MPC (€)	MPC (Kn)	Šifra artikla	Dostupnost
30 - 90	269,31	2.029,09	402545	Ⓛ

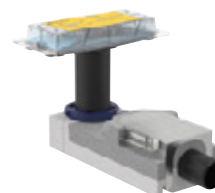

Cleanline

Građevinski set za podni odvod kanalice, visina ugradnje min. 90 mm. Koristi se s tuš kanalicom Cleanline20.

Dimenzije (cm)	MPC (€)	MPC (Kn)	Šifra artikla	Dostupnost
	188,54	1.420,55	402538	Ⓛ



Cleanline

Građevinski set za podni odvod kanalice, visina ugradnje min. 65 mm. Koristi se s tuš kanalicom Cleanline20.

Dimenzije (cm)	MPC (€)	MPC (Kn)	Šifra artikla	Dostupnost
	188,54	1.420,55	402539	Ⓛ



Varino

Podni sifon s inox rešetkom.

Dimenzije (cm)	MPC (€)	MPC (Kn)	Šifra artikla	Dostupnost
10x10	226,53	1.706,76	605045	

GEBERIT Cleanline 20 | Ⓛ

Tuš kanalice iz Geberita, Cleanline20, zaista je sve što trebate od kanalice. Osim lijepog, neupadljivog dizajna, sadrži nekoliko bitnih elemenata: češalj za hvatanje kose, uljevni nastavak s prstenom za izjednačavanje, dva završna komada te vakumskim podizačem.

Ova kanalice pogodna je za odvodnju pojedinačnih tuševa u ravnini poda, za ugradnju uz zid ili u sredinu prostora za debljinu keramičkih pločica od 8 mm do 35 mm.

KOLPA SAN / NOVELLINI / BETTE



Kolpa Elektra

Ugradbena akrilna kada, bijela.

Dimenzije (cm)	Boja	MPC (€)	MPC (Kn)	Šifra artikla	Dostupnost
160x75	○	474,15	3.572,49	219636	
170x70	○	474,15	3.572,49	219637	
170x75	○	386,41	2.911,41	219638	Ⓛ
170x80	○	509,60	3.839,59	219639	
180x80	○	419,50	3.160,71	219640	Ⓛ



Novellini Calos

Ugradbena akrilna kada, bijela.

Dimenzije (cm)	Boja	MPC (€)	MPC (Kn)	Šifra artikla	Dostupnost
160x70	○	250,83	1.889,88	478489	
170x70	○	250,83	1.889,88	478490	
170x75	○	197,44	1.487,64	478491	Ⓛ
170x80	○	246,80	1.859,55	478492	
180x80	○	197,44	1.487,64	478493	Ⓛ



BetteForm

Ugradbena čelična kada, bijela. Dostupna u Bette bojama.

Dimenzije (cm)	Boja	MPC (€)	MPC (Kn)	Šifra artikla	Dostupnost
160x70	○	617,23	4.650,54	859695	
160x75	○	617,23	4.650,54	858479	
170x70	○	617,23	4.650,54	855053	
170x75	○	617,14	4.649,85	994861	
180x80	○	645,05	4.860,84	886295	

Estetski dopadljive kupaonske kade, koje čine kupaonicu modernom, iz Bette, Novellini te Kolpa San tvornica tu su da vam olakšaju izbor.

Već na prvu, kade ovih triju proizvođača imaju sve što poželite: vrhunsku kvalitetu i divan, elegantan dizajn. Osim toga, ova tri proizvođača pobrinula su se da zadovolje različite zahtjeve, stoga sve kade imaju nekoliko različitih dimenzija na izbor.



FLAMINIA / JACUZZI



Flaminia APP

Samostojeća kada s prelievnom, od materijala pietraluce, mliječno bijela. Kada i obloga su iz jednog dijela. Dostupna u 11 boja.

Dimenzije (cm)	Boja	MPC (€)	MPC (Kn)	Šifra artikla	Dostupnost
176x91	○	3.039,35	22.900,00	604593	

Samostojeće kade iz tvornica Flaminia i Jacuzzi savršeni su ukras svake kupaonice. Mogu se postaviti na bilo koje mjesto u kupaonici te izgledaju veoma profinjeno i stilski.

Ove dvije tvornice prednjače kvalitetom i dizajnom te dugi niz godina postavljaju trendove u kupaonskom svijetu. Bilo da je riječ o ovalnom ili četvrtastom obliku, samostojeća tuš kada apsolutno podiže dojam te stvara dojam luksuznog uređenja.



Jacuzzi Desire

Samostojeća akrilna kada s prelievom, bijela. Kada i obloga su iz jednog dijela.

Dimenzije (cm)	Boja	MPC (€)	MPC (Kn)	Šifra artikla	Dostupnost
185x95	○	2.571,30	19.373,45	1049226	



Jacuzzi Esprit

Samostojeća akrilna kada s prelievom, bijela. Kada i obloga su iz jednog dijela.

Dimenzije (cm)	Boja	MPC (€)	MPC (Kn)	Šifra artikla	Dostupnost
170x80	○	2.054,97	15.483,20	1049227	

JACUZZI Desire samostojeća kada

JACUZZI Esprit samostojeća kada



KOLPA SAN



Komodo

Samostojeća akrilna kada s preljevom, bijela. Kada i obloga su iz jednog dijela. Dostupno u crnoj, sivoj i bijeloj boji.

Dimenzije (cm)	Boja	MPC (€)	MPC (Kn)	Šifra artikla	Dostupnost
185x90	○	1.982,27	14.935,45	586039	



Dalia

Samostojeća akrilna kada s preljevom, bijela. Kada i obloga su iz jednog dijela. Dostupno u crnoj, sivoj i bijeloj boji.

Dimenzije (cm)	Boja	MPC (€)	MPC (Kn)	Šifra artikla	Dostupnost
170x80	○	2.062,04	15.536,44	586053	



Pandora

Samostojeća akrilna kada s preljevom i UP&DOWN sustavom sa sifonom, bijela. Kada i obloga su iz jednog dijela.

Dimenzije (cm)	Boja	MPC (€)	MPC (Kn)	Šifra artikla	Dostupnost
163x68	○	2.211,23	16.660,49	586052	
173x78	○	2.255,54	16.994,36	586051	

KOLPA SAN Pandora samostojeća kada



KOLPA SAN Komodo samostojeća kada



Samostojeće kade iz Kolpe savršeno se prilagođavaju vašim potrebama. Kade izrađene od lijevanog akrila kvalitetne su i zaista lijepe.

Comodo, Dalia i Pandora tri su kolekcije koje udovoljavaju različitim stilovima a istovremeno su klasične te ne podliježu novim trendovima.

NOVELLINI

KALI



NOVELLINI Kali klizna tuš vrata | L

Kolekcija Kali iz Novellinija pokriva standardne dimenzije kupaonskih kabina te nudi izbor dizajna ovisno o vašim potrebama. Tako se u ovoj kolekciji, koja je dostupna na našem lageru, može pronaći i polukružna tuš kabina. Gotovo sva klizna vrata se mogu kombinirati s fiksnom stijenom ili kliznim tuš vratima. Lijep i profinjen dizajn te vrhunska kvaliteta proizvoda Novellinija, dobitna su kombinacija za uređenje vaše kupaonice.

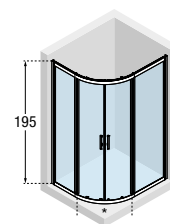

Kali R 90

Klizna polukružna tuš kabina s prozirnim staklom i srebrnim profilom visine 195 cm.

Dimenzije (cm)	MPC (€)	MPC (Kn)	Šifra artikla	Dostupnost
87-90	445,34	3.355,43	435854	Ⓛ

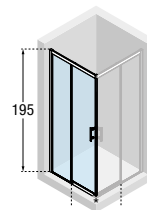

Kali AH

Klizna tuš vrata s prozirnim staklom i srebrnim profilom visine 195 cm. Mogu se kombinirati s fiksnom stijenom ili kliznim tuš vratima.

	Dimenzije (cm)	MPC (€)	MPC (Kn)	Šifra artikla	Dostupnost
Kali AH 76	77,5-79	191,83	1.445,34	435855	Ⓛ
Kali AH 86	87,5-89	204,03	1.537,27	435856	Ⓛ
Kali AH 96	97,5-99	212,16	1.598,55	435857	Ⓛ

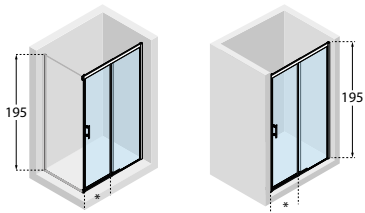

Kali PH 116

Klizna tuš vrata s prozirnim staklom i srebrnim profilom visine 195 cm. Mogu se kombinirati s fiksnom stijenom ili za montažu u niši.

Dimenzije (cm)	MPC (€)	MPC (Kn)	Šifra artikla	Dostupnost
118-119,5	263,00	1.981,59	435858	Ⓛ

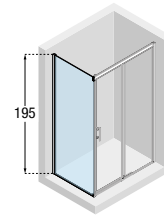

Kali FH 78

Fiksna tuš stijena s prozirnim staklom i srebrnim profilom visine 195 cm. Kombinira se s tuš vratima.

Dimenzije (cm)	MPC (€)	MPC (Kn)	Šifra artikla	Dostupnost
78-79,5	170,14	1.281,91	435859	Ⓛ

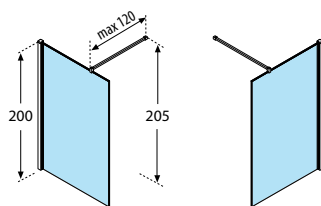

Kali H 120

Tuš stijena s prozirnim staklom i srebrnim profilom visine 200 cm.

Dimenzije (cm)	MPC (€)	MPC (Kn)	Šifra artikla	Dostupnost
89-90	336,21	2.533,17	481429	Ⓛ
97-100	336,21	2.533,17	491004	Ⓛ
117-120	357,22	2.691,49	596358	Ⓛ



NOVELLINI Kali tuš kabina | Ⓛ



NOVELLINI Kali tuš stijena | Ⓛ



NOVELLINI



NOVELLINI Brera tuš kabina



NOVELLINI Opera tuš kabina

Novellini vrhunska kvaliteta i luksuzan dizajn savršena su kombinacija za sve ljubitelje estetike. Inovativne ideje iz Novellinija čine tuš stijene i vrata veoma funkcionalnim i poželjnim proizvodima.

Osim što nude različite dizajne, nude i niz tehničkih aspekata. Mogu se podešavati ovisno o vašim potrebama te dolaze u velikom broju dimenzija.



NOVELLINI Kuadra 2.0 klizna tuš vrata



NOVELLINI Kuadra H Frame tuš stijena



NOVELLINI Kuadra H tuš stijena



NOVELLINI Young tuš kabina



NOVELLINI Young 2.0 tuš kabina

DUKA



DUKA Aqua 5000 tuš kabina

Dukine tuš kabine zaista su dizajnersko remek djelo. Bilo da želite jednostavne i neupečatljive stijene ili elegantna vrata s lijepim profilima, u Duki ćete pronaći sve što će odgovarati vašem ukusu i stilu. Svojom kvalitetom i sigurnošću ističu se na tržištu već dugi niz godina te su zaista jedinstvene radi dizajna, ali i zbog mnogo različitih tehničkih značajki koje znatno olakšavaju svakodnevno korištenje.



DUKA Libero 5000 klizna tuš stijena



DUKA Libero 3000 tuš stijena



DUKA Pura 5000 tuš kabina



DUKA Aqua 5000 klizna tuš vrata















DUKA Pura 5000 tuš kabina



DUKA Pura 5000 tuš kabina

UNIVERZALNO

 <p>Geberit</p> <p>Uniflex izljevna sifonska garnitura za tuš kadu Ø 50 mm, s poklopcem odvoda, visina vodenog stupca 50 mm, krom.</p>	 <p>Geberit</p> <p>Izljevna sifonska garnitura za tuš kadu Ø 90 mm, s poklopcem odvoda, visina vodenog stupca 50 mm, krom.</p>	 <p>Geberit</p> <p>Odvod tuš kade Ø 90 mm, visina vodenog stupca 50 mm.</p>	<p>Boja</p> <p>Dostupnost</p> <p>Šifra artikla</p> <p>MPC (€) MPC (Kn)</p>
 <p>Geberit</p> <p>Odvod tuš kade Ø 90 mm, visina vodenog stupca 30 mm.</p>	 <p>Geberit</p> <p>Poklopac odvoda Ø 90 mm, za Geberit odvod tuš kade, bijeli.</p>	 <p>Geberit</p> <p>Poklopac odvoda Ø 90 mm, za Geberit odvod tuš kade, krom.</p>	<p>Boja</p> <p>Dostupnost</p> <p>Šifra artikla</p> <p>MPC (€) MPC (Kn)</p>
 <p>Catalano</p> <p>Izljevna sifonska garnitura za tuš kadu Ø 90 mm, s poklopcem odvoda, visina vodenog stupca 50 mm, krom.</p>	 <p>Geberit</p> <p>Izljevno preljevna garnitura za kadu otvora Ø 52 mm.</p>	 <p>Geberit</p> <p>Uniflex Push Control izljevno preljevna garnitura za kadu otvora Ø 52 mm.</p>	<p>Boja</p> <p>Dostupnost</p> <p>Šifra artikla</p> <p>MPC (€) MPC (Kn)</p>
 <p>TECEdrainpoint S 110</p> <p>Komplet podnog odvoda s priрубnicom i rešetkom dimenzije 10x10 cm od plemenitog čelika.</p>	 <p>TECEdrainpoint S 112</p> <p>Komplet podnog odvoda s priрубnicom, okvirom za rešetku od plemenitog čelika i rešetkom dimenzije 10x10 cm od plemenitog čelika te membranskim zatvaračem neugodnih mirisa.</p>	 <p>TECEdrainpoint S</p> <p>Set nasadnog dijela s okvirom za rešetku od plemenitog čelika 15 cm i popločivog umetka za keramičke pločice.</p>	<p>Boja</p> <p>Dostupnost</p> <p>Šifra artikla</p> <p>MPC (€) MPC (Kn)</p>



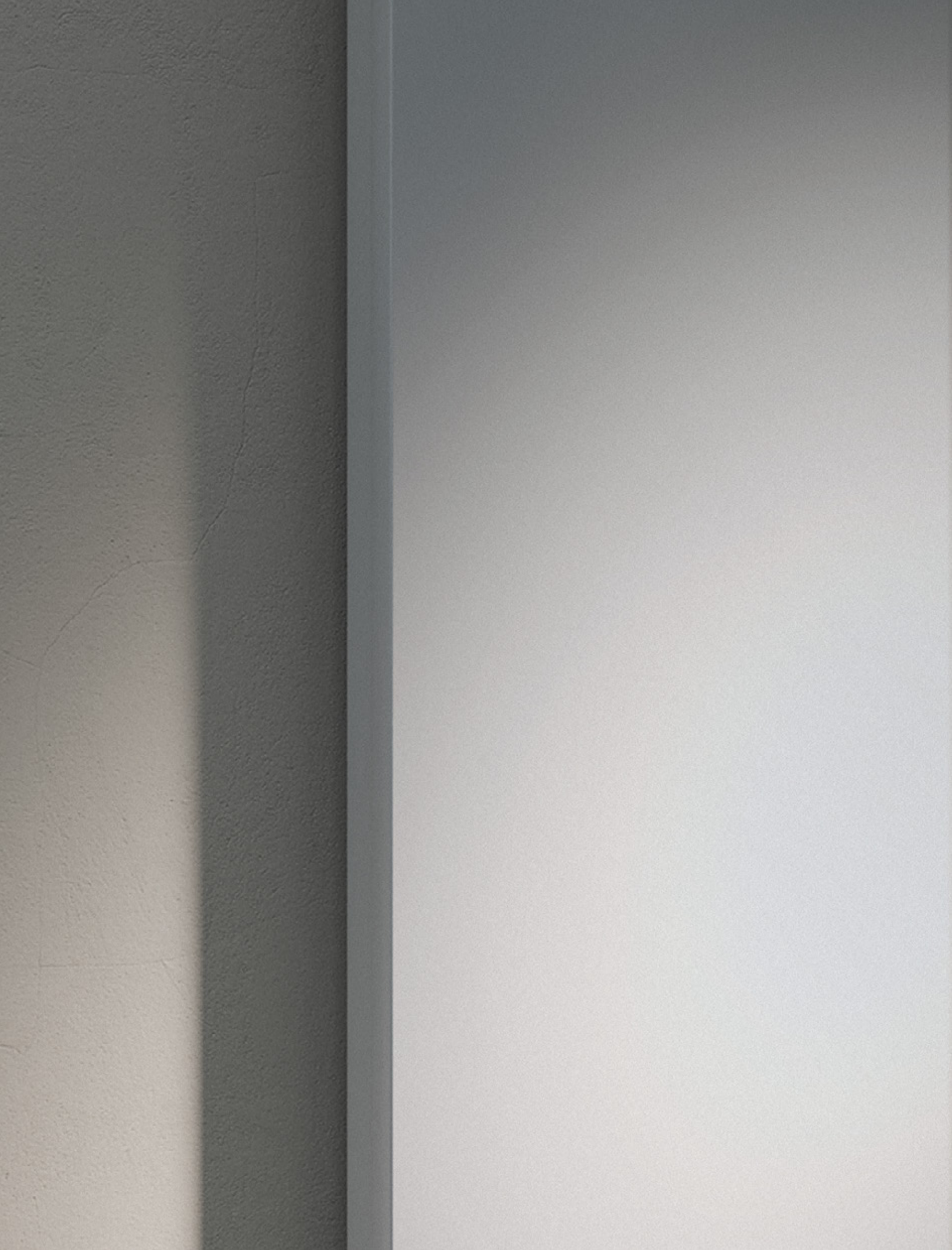

RADIJATORI
-
MINI BAZENI
-
PARKETI
-
PREMAZ

CALEIDO

ULISSE



CALEIDO Ulisse radiator | 



Ulisse





Električni radiator, bijeli.

Dimenzije (mm)	MPC (€)	MPC (Kn)	Šifra artikla	Dostupnost
76,6x50	242,28	1.825,43		
118,5x50	278,02	2.094,75		
150,6x50	313,77	2.364,08		



Ulisse

Hidraulični radiator, bijeli.

Dimenzije (mm)	MPC (€)	MPC (Kn)	Šifra artikla	Dostupnost
76,6x50	78,38	590,52	819965	
118,5x50	108,03	813,96	819966	
150,6x50	135,57	1.021,44	819967	
181,7x50	167,34	1.260,84	819968	
76,6x60	105,91	798,00		
118,5x60	137,69	1.037,40		
150,6x60	174,76	1.316,70		
181,7x60	214,47	1.615,95		



Ulisse

Električni radijator, crni.

Dimenzije (mm)	MPC (€)	MPC (Kn)	Šifra artikla	Dostupnost
76,6x50	369,37	2.783,03		
118,5x50	467,34	3.521,18		
150,6x50	548,10	4.129,65		



Ulisse

Hidraulični radijator, crni.

Dimenzije (mm)	MPC (€)	MPC (Kn)	Šifra artikla	Dostupnost
76,6x50	222,42	1.675,80		
118,5x50	320,39	2.413,95		
150,6x50	352,16	2.653,35		
181,7x50	458,07	3.451,35		
76,6x60	233,01	1.755,60		
118,5x60	330,98	2.493,75		
150,6x60	402,47	3.032,40		
181,7x60	471,31	3.551,10		

Iz tvornice Caleido dolaze radijatori za kupaonicu klasičnog, tradicionalnog dizajna. Ovisno o vašim željama, radijatori iz kolekcije Ulisse mogu biti u hidrauličnoj i električnoj varijanti te u bijeloj ili crnoj boji.

Kako bi vaša kupaonica imala ugodnu atmosferu, naročito za vrijeme hladnih dana, pobrinuli smo se da vam radijatori budu dostupni odmah. Na našem lageru možete pronaći četiri dimenzije u bijeloj boji.



CALEIDO Ulisse radijator | L

TUBES



TUBES Kubik



TUBES Rift

Topla strana dizajna predstavljena u Tubes radiatorima ostavit će vas bez daha. Ne biste vjerovali, ali radiator postaje ukras u vašem domu.

Neobičnog dizajna, oblika i posebno lijepih boja, Tubes radiatori prave su skulpture i remek-djela. Ovi dizajnerski dekorativni radiator postat će vaša omiljena stvar u domu. Zahvaljujući različitim potrebama, Tubes je stvorio mnogo različitih varijanti radiatora te pokrivaju sve stilove dizajna i sve tehničke različitosti.



TUBES Basics 14

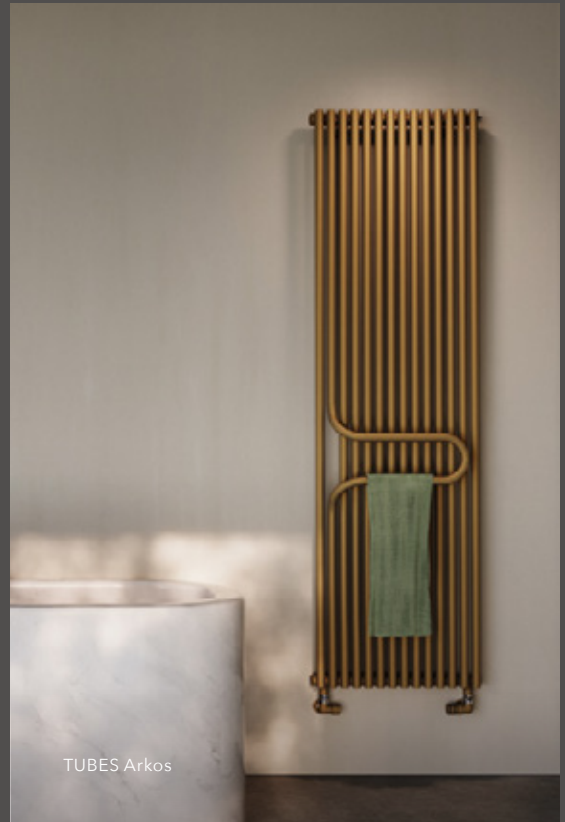

TUBES Arkos



TUBES Scaletta



TUBES Platform

NOVELLINI



Novellini Divina niz je funkcionalnih mini bazena koji će svakom prostoru unijeti luksuz i eleganciju. Vaš dom može postati vaša privatna wellness oaza koju kreirate isključivo po svom ukusu i prema svojim potrebama. Dolaze u četiri različite veličine te se mogu koristiti u unutarnjem i vanjskom prostoru.

Divina je kolekcija koja se u potpunosti prilagođava čovjeku i njegovoj udobnosti, stoga su masažni elementi, čije mlaznice imaju mnogo opcija masiranja, te prostor za sjedenje dovedeni do savršenstva. Divina je eco-friendly te nudi mogućnost biranja obloga, a ovisno o tome želite li

bazen unutra ili vani, biraju se i materijali prigodni za situaciju. Isto tako, može se odabrati i boja unutrašnjosti bazena. Uz nekoliko spomenutih opcija, Divina nudi još mnogo drugih opcija kojima možete unaprijediti svoj bazen iz snova. Održavanje je vrlo jednostavno jer su površine glatke te su mlaznice napravljene tako da se u njima ne zadržava prljavština.

Svaki proizvod iz Novellinija doveden je do najviše razine, a za cilj ima stvoriti savršen balans između uma i tijela te povećati kvalitetu života ljudima. Ekskluzivna kolekcija Divina u vaš će život unijeti harmoniju i novu ljepotu uživanja.



NOVELLINI Divina mini bazen



NOVELLINI Divina mini bazen



NOVELLINI Divina mini bazen



NOVELLINI Divina mini bazen



NOVELLINI Divina mini bazen



NOVELLINI Divina mini bazen

IPF



IPF parket

IPF nudi velik izbor parketa za različite stilove uređenja interijera. Od najkvalitetnijeg drva, IPF radi na razvoju proizvoda te se trudi dovesti kvalitetu do savršenstva. U mnoštvu mogućnosti parketa, možete birati između mnogo različitih boja te čitavog spektra nijansi. Osim toga, svaki parket ima svoje jedinstvene efekte, pa tako mogu biti s efektom metalnog sjaja, sedefastog sjaja, a mogu biti mat i lakirani.

S preko 30 godina iskustva, talijanski dizajn parketa dospio je na sam vrh tržišta te su postali predvodnici postavljanja novih trendova. Njihovom radu punom ljubavi prema drvetu svjedoči i činjenica da se završne obrade rade ručno pa su zbog toga ovi parketi zaista jedinstvenog izgleda.



IPF parket



IPF parket



IPF parket



IPF parket



IPF parket

KERAKOLL WARM COLLECTION



KERAKOLL Warm Collection

Novi stil uređenja interijera, u kojem se materijali, teksture i boje stapaju jedan s drugim: upravo to je svrha Kerakoll Warm kolekcije. Premazi za podove, zidove, namještaj, rasvjetnu opremu, svjetlosne i strojarske instalacije – sve postaje jedna površina.

Posebno lijepe, dizajnerske boje i glazure daju ljepotu svakom prostoru te gotovo da ne postoji površina koja se ne može pobojati Kerakollom.

Zamislite da pločice, koje su vam dosadile izgledom, možete jednostavno premazati divnom bojom te čak sakriti i fuge. Ovaj divan, inovativan dizajn Kerakoll Warm dolazi u spektru od 10 toplih boja između kojih se zaista teško odlučiti za onu najljepšu, a osim samih boja, možete birati i između nekoliko tekstura.



KERAKOLL Warm Collection



KERAKOLL Warm Collection



KERAKOLL Warm Collection



KERAKOLL Warm Collection



KERAKOLL Warm Collection

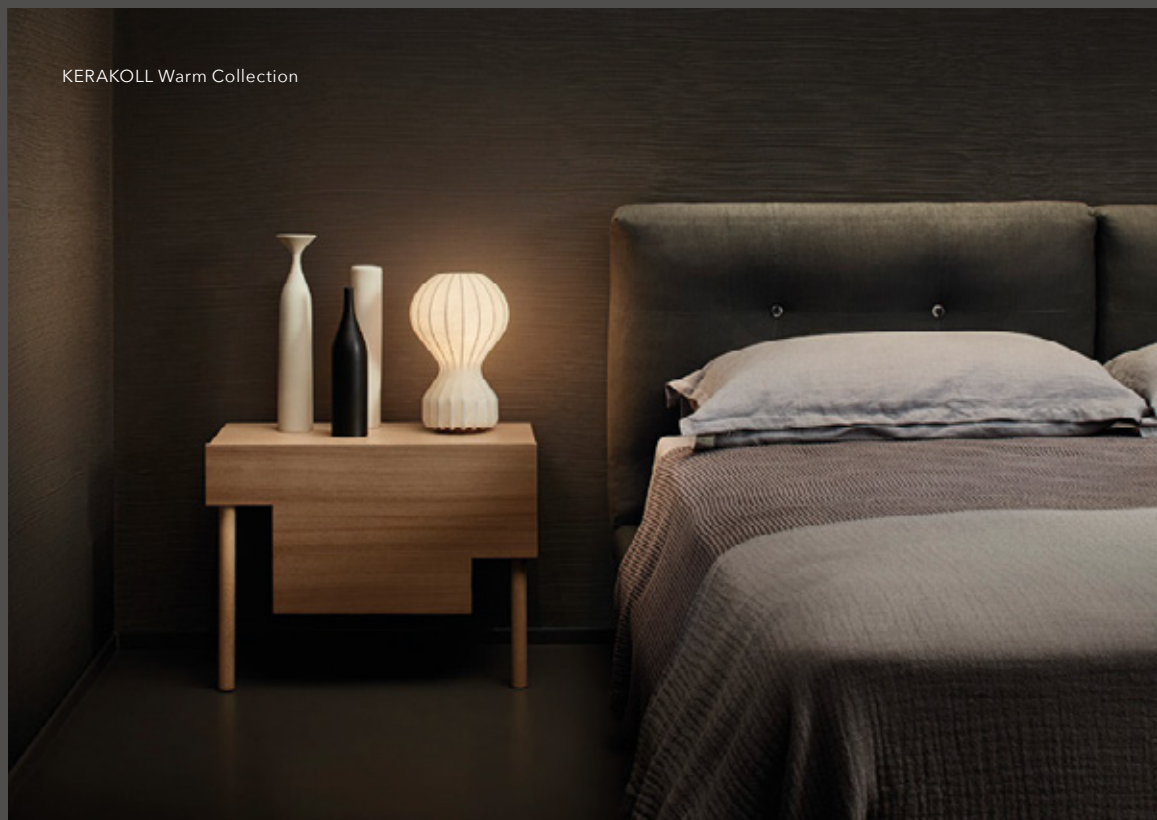

KERAKOLL Warm Collection



VODOKOTLIĆI I
AKTIVACIJSKE TIPKE
-
LJEPILA
-
HIDROIZOLACIJA I
GRIJANJE

GEBERIT

Geberit ima odgovarajuće rješenje za sve potrebe kupaonice. Praktičnost proizvoda olakšava svakodnevno korištenje kupaonice te se, ovisno o tehničkim predispozicijama, mogu birati različite vrste proizvoda. Ništa manje nije bitan niti dizajn, pa su tako aktivacijske tipke iz Geberita prava mala umjetnička djela.

U velikom izboru dizajna, materijala i boja, tipka za wc postat će zanimljiv detalj u kupaonici.



GEBERIT Sigma50 aktivacijska tipka za wc

GEBERIT



Ⓛ
113519
164,06 1.236,09

Kombifix

Ugradbeni vodokotlić za mokru ugradnju visine 108 cm, Delta.



Ⓛ
113520
201,00 1.514,43

Duofix

Ugradbeni vodokotlić za suhu ugradnju visine 112 cm, Delta.



Ⓛ
175202
235,59 1.775,04

Kombifix

Ugradbeni vodokotlić za mokru ugradnju visine 108 cm, Sigma.

Dostupnost
Šifra artikla
MPC (€) MPC (Kn)



Ⓛ
175205
318,27 2.398,00

Duofix

Ugradbeni vodokotlić za suhu ugradnju visine 112 cm, Sigma.



Ⓛ
1035410
31,81 239,69

Delta01

Aktivacijska tipka za wc, plastična, bijela.



Ⓛ
1035409
41,96 316,18

Delta20

Aktivacijska tipka za wc, plastična, bijela.

Dostupnost
Šifra artikla
MPC (€) MPC (Kn)



Ⓛ
1034944
47,90 360,92

Delta50

Aktivacijska tipka za wc, plastična, bijela.



Ⓛ
300657
52,21 393,41

Sigma01

Aktivacijska tipka za wc, plastična, bijela.



Ⓛ
300663
61,34 462,15

Sigma01

Aktivacijska tipka za wc, plastična, crna.

Dostupnost
Šifra artikla
MPC (€) MPC (Kn)



Ⓛ
300658
74,38 560,41

Sigma01

Aktivacijska tipka za wc, plastična, krom sjajna.



Ⓛ
846809
73,52 553,95

Sigma01

Aktivacijska tipka za wc, plastična, krom mat.















Ⓛ
452042
84,03 633,11

Sigma20

Aktivacijska tipka za wc, plastična, bijela/ krom sjajna.

Dostupnost
Šifra artikla
MPC (€) MPC (Kn)

GEBERIT

	452043 109,56 825,48		Ⓛ 846814 146,04 1.100,36		573728 332,71 2.506,80	Dostupnost Šifra artikla MPC (€) MPC (Kn)
Sigma20 Aktivacijska tipka za wc, plastična, bijela/ zlatna.		Sigma20 Aktivacijska tipka za wc, plastična, crna mat.		Sigma21 Aktivacijska tipka za wc od stakla, bijela/ krom sjajna.		
	846783 613,69 4.623,85		Ⓛ 452049 87,06 655,98		452050 132,87 1.001,09	Dostupnost Šifra artikla MPC (€) MPC (Kn)
Sigma21 Aktivacijska tipka za wc od stakla, crna sjajna.		Sigma30 Aktivacijska tipka za wc, plastična, bijela/ krom sjajna.		Sigma30 Aktivacijska tipka za wc, plastična, bijela/ zlatna.		
	Ⓛ 846818 166,58 1.255,13		604495 243,16 1.832,10		846803 548,35 4.131,51	Dostupnost Šifra artikla MPC (€) MPC (Kn)
Sigma30 Aktivacijska tipka za wc, plastična, crna mat.		Sigma50 Aktivacijska tipka za wc od stakla, bijela/ krom sjajna.		Sigma50 Aktivacijska tipka za wc od stakla, bijela/ zlatna.		
	604508 246,02 1.853,63		Ⓛ 402483 35,20 265,20		Ⓛ 886603 4,71 35,51	Dostupnost Šifra artikla MPC (€) MPC (Kn)
Sigma50 Aktivacijska tipka za wc od stakla, crna/ krom.		Geberit Okvir za ubacivanje stickova za dezinfekciju vodokotlića i wc školjke, za Sigma ugradbeni vodokotlić.		Geberit DuoFresh stick za dezinfekciju vodokotlića i wc školjke, pakiranje sadrži 8 stickova.		

GEBERIT Sigma50 aktivacijska tipka za wc



TECE

TECE vodokotlići, kao i aktivacijske tipke, nude vrhunsku kvalitetu. Mali, ali praktični detalji čine TECE proizvode jedinstvenima i drugačijima te se svaki vodokotlić može kombinirati s bilo kojom aktivacijskom tipkom.

Aktivacijske tipke ističu se i lijepim dizajnom te se zaista teško odlučiti za onu najljepšu.



TECEsquare aktivacijska tipka za wc

TECE



Ⓛ
887977
144,40 1.088,00

TECEbase

Ugradbeni vodokotlić za suhu ugradnju, visine 112 cm, s montažnim setom.



Ⓛ
889422
160,20 1.207,00

TECEbase

Ugradbeni vodokotlić za suhu ugradnju, visine 112 cm, sa zvučnom izolacijom, montažnim setom i aktivacijskom tipkom TECEnow, bijelom.



Ⓛ
966090
159,07 1.198,50

TECEbox

Ugradbeni vodokotlić za mokru ugradnju visine 106 cm.



Ⓛ
889287
194,04 1.462,00

TECEprofil

Ugradbeni vodokotlić za suhu ugradnju, visine 112 cm, sa zvučnom izolacijom i montažnim setom.



Ⓛ
357838
135,38 1.020,00

TECEprofil

Modul za konzolni bide za suhu ugradnju, visine 112 cm.



Ⓛ
867344
1.218,40 9.180,00

TECEone

WC školjka s funkcijom bidea, s wc daskom i predinstalacijskim setom, bijela.



Ⓛ
432746
43,32 326,40

TECEnow

Aktivacijska tipka za wc, bijela.



Ⓛ
823821
54,60 411,40

TECEnow

Aktivacijska tipka za wc, crna mat.



Ⓛ
889378
49,64 374,00

TECEloop

Aktivacijska tipka za wc, plastična, bijela.



Ⓛ
966074
57,54 433,50

TECEloop

Aktivacijska tipka za wc, plastična, krom mat.



Ⓛ
966073
57,54 433,50

TECEloop

Aktivacijska tipka za wc, plastična, krom sjajna.



Ⓛ
358029
49,64 374,00

TECEloop

Aktivacijska tipka za wc od stakla, bijela/ krom. Dostupno i u drugim bojama.

Dostupnost

Šifra artikla

MPC (€)
MPC (Kn)

Dostupnost

Šifra artikla

MPC (€)
MPC (Kn)

Dostupnost

Šifra artikla

MPC (€)
MPC (Kn)

Dostupnost

Šifra artikla

MPC (€)
MPC (Kn)

TECE

	357850 195,41 1.472,31		Ⓛ 432753 269,63 2.031,50		Ⓛ 432754 297,83 2.244,00	Dostupnost Šifra artikla MPC (€) MPC (Kn)
TECEsquare Aktivacijska tipka za wc od stakla, bijela. Dostupno i u drugim bojama.		TECEsquare Aktivacijska tipka za wc od plemenitog čelika, krom mat.		TECEsquare Aktivacijska tipka za wc od plemenitog čelika, krom sjajna.		
	Ⓛ 468835 297,83 2.244,00		Ⓛ 389389 24,14 181,90		Ⓛ 612275 12,41 93,50	Dostupnost Šifra artikla MPC (€) MPC (Kn)
TECEsquare Aktivacijska tipka za wc od plemenitog čelika, crna mat.		TECE Okno za ubacivanje tablete za dezinfekciju vodokotlića i wc školjke, za sve TECE ugradbene vodokotliće.		TECE Tablete za održavanje vodokotlića i wc školjke, pakiranje sadrži 10 tableta.		

TECEsquare aktivacijska tipka za wc



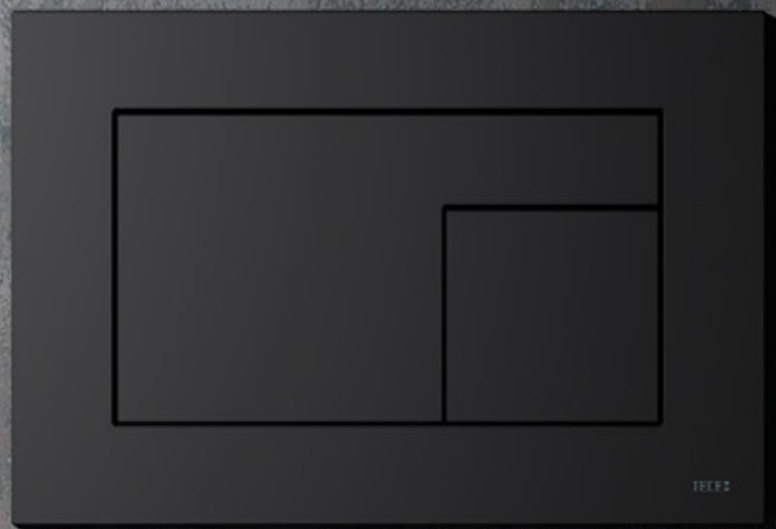

TECEvelvet aktivacijska tipka za wc

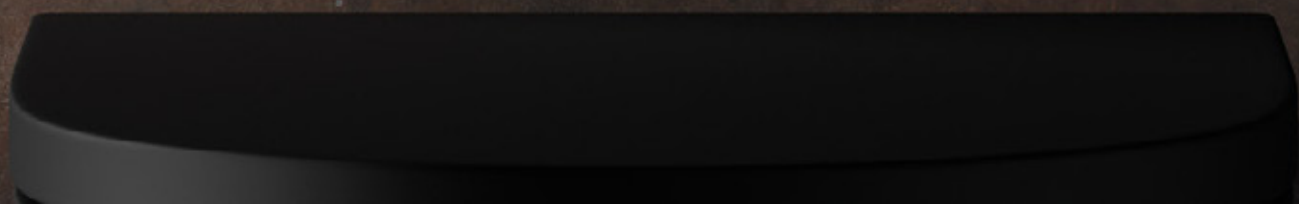











KERAKOLL



Kerakoll je budućnost zelenog svijeta. Gradimo, ali poštujemo okoliš. U svojem asortimanu Kerakoll nudi mnoštvo proizvoda, a mi donosimo probrane artikle za koje smatramo kako su ključ olakšane gradnje. Osim što su proizvodi bio, imaju vrhunske karakteristike te kvalitetu, a niti estetika ne zaostaje.

Svi Kerakoll proizvodi dolaze u širokom spektru boja, od kojih neki nude čak i do pedeset nijansi. Igrajte se bojama fuga i silikona, neka svaki detalj postane bitan.

	Boja	MPC (€) MPC (Kn)	Dostupnost	Mjerna jedinica
	Bioflex E Ljepilo, bijelo, 25 kg.	0,84 6,37	Ⓛ	kg
	Bioflex E Ljepilo, sivo, 25 kg.	0,86 6,51	Ⓛ	kg
	Biofix E Ljepilo, bijelo, 25 kg.	0,60 4,53	Ⓛ	kg
	Biofix E Ljepilo, sivo, 25 kg.	0,59 4,46	Ⓛ	kg
	Fugabella Eco Porcelana 0-5 fugirna masa, bijela, 5 kg.	1,86 14,04	Ⓛ	kg
	Fugabella Eco Porcelana 0-5 fugirna masa, boje 06, 04, 24, 5 kg.	2,18 16,47	Ⓛ	kg
	Fugabella Color fugirna masa, boje 02, 03, 05, 06, 07, 09, 10, 11, 12, 26, 31, 36, 45, 46, 3 kg.	3,79 28,56	Ⓛ	kg

	Boja	MPC (€) MPC (Kn)	Dostupnost	Mjerna jedinica
		5,90 44,49	Ⓛ	kom
	01	10,03 75,57	Ⓛ	kom
	02 03 04 07 08	10,25 77,25	Ⓛ	kom
	02 03 05 06 07 09 10 11 12 20 21 26 31 45 46	13,45 101,33	Ⓛ	kom













MAPEI



Održivi svijet ono je što Mapei želi postići svojim proizvodima. Zahvaljujući inovativnim proizvodima i vrhunskoj tehnologiji, učinak na okoliš vrlo je malen.

Mapei u svojem asortimanu nudi proizvode koji pokrivaju potrebe "od temelja do krova". Na vodećoj su poziciji u proizvodnji ljepila, brtvila i kemijskih proizvoda za građevinsku industriju, a mi smo ono najbolje i najčešće traženo osigurali na lageru.

	Boja	MPC (€) MPC (Kn)	Dostupnost	Mjerna jedinica
	Keraflex ljepilo, bijelo, 25 kg.	0,88 6,60	Ⓛ	kg
	Keraflex ljepilo, sivo, 25 kg.	0,81 6,10	Ⓛ	kg
	Keraflex Maxi S1 ljepilo, bijelo, 23 kg.	1,22 9,20	Ⓛ	kg
	Keraflex Maxi S1 zero ljepilo, sivo, 25 kg.	1,10 8,30	Ⓛ	kg
	Keracolor FF-DE fugirna masa N.100, N.110, N.111, N.112, N.113, N.114, N.130, N.132, N.142, 5 kg.	1,53 11,50	Ⓛ	kg
	Keracolor GG fugirna masa N.110 Manhattan, 5 kg.	1,27 9,60	Ⓛ	kg
	Keracolor GG fugirna masa N.113 cementno siva, 5 kg.	1,27 9,60	Ⓛ	kg

	Boja	MPC (€) MPC (Kn)	Dostupnost	Mjerna jedinica																				
 <p>Ultracolor Plus fugirna masa N.100, N.103, N.111, N.110, N.112, N.113, N.114, N. 120, N.130, N.132, N.133, N.134, N.135, N.136, N.141, N. 142, N. 144, 5 kg.</p>	<table border="1"> <tr><td>100</td><td>103</td><td>110</td><td>111</td><td>112</td></tr> <tr><td>113</td><td>114</td><td>120</td><td>130</td><td>132</td></tr> <tr><td>133</td><td>134</td><td>135</td><td>136</td><td>141</td></tr> <tr><td></td><td>142</td><td>144</td><td></td><td></td></tr> </table>	100	103	110	111	112	113	114	120	130	132	133	134	135	136	141		142	144			3,93 29,60	Ⓛ	kg
100	103	110	111	112																				
113	114	120	130	132																				
133	134	135	136	141																				
	142	144																						
 <p>Mapeflex PU45 silikonsko brtvilo N.113, cementno sivo.</p>	<table border="1"> <tr><td>113</td></tr> </table>	113	8,80 66,31	Ⓛ	kom																			
113																								
 <p>Mapesil AC silikonsko brtvilo N.100, N.111, N.110, N.112, N.113, N.114, N.120, N.130, N.132, N.141, N.142,, N.144, N.999. Mapesil AC silikonsko brtvilo N.103, N. 133, N.134,N.135,N.136</p>	<table border="1"> <tr><td>100</td><td>103</td><td>110</td><td>111</td><td>112</td></tr> <tr><td>113</td><td>114</td><td>120</td><td>130</td><td>132</td></tr> <tr><td>133</td><td>134</td><td>135</td><td>136</td><td>141</td></tr> <tr><td></td><td>142</td><td>144</td><td>999</td><td></td></tr> </table>	100	103	110	111	112	113	114	120	130	132	133	134	135	136	141		142	144	999		9,74 73,41	Ⓛ	kom
100	103	110	111	112																				
113	114	120	130	132																				
133	134	135	136	141																				
	142	144	999																					





















SCHLÜTER SYSTEMS



Schlüter nudi asortiman od preko 10 000 provjerenih rješenja za sve što je potrebno u svijetu građevine. U moru proizvoda i praktičnih rješenja koje Schlüter nudi, pobrinuli smo se da one najvažnije i najčešće tražene imamo dostupne na lageru.

Njemačka kvaliteta uvijek ulijeva povjerenje stoga smo sigurni kako će i ovi proizvodi biti najbolje od najboljeg u vašem domu.

		MPC (€) MPC (Kn)	Šifra artikla	Dostupnost	Mjerna jedinica
	Ditra 25 polietilenska folija s funkcijom hidroizolacije, odvajanja i otpuštanja tlaka pare, distribucijom opterećenja i homogenom difuzijom topline. Širina 1 m, dužina 5 m.	20,78 156,58	433007	Ⓛ	m ²
	Ditra 25 polietilenska folija s funkcijom hidroizolacije, odvajanja i otpuštanja tlaka pare, distribucijom opterećenja i homogenom difuzijom topline. Širina 1 m, dužina 30 m.	17,23 129,85	433006	Ⓛ	m ²
	Ditra-Drain 4 polietilenska folija s funkcijom pasivne kapilarne odvodnje, s mikroventilacijom i funkcijom odvajanja koja omogućava neutraliziranje napetosti do koje dolazi uslijed širenja slojeva. Širina 1 m, dužina 25 m.	22,74 171,37	454966	Ⓛ	m ²
	Kerdi-200 polietilenska hidroizolacijska membrana pogodna za postavljanje na pod i zid, spojevi se brtve ljepljivom Kerdi Coll-L. Širina 1 m, dužina 5 m.	20,88 157,29	554503	Ⓛ	m ²
	Kerdi-200 polietilenska hidroizolacijska membrana pogodna za postavljanje na pod i zid, spojevi se brtve ljepljivom Kerdi Coll-L. Širina 1 m, dužina 30 m.	20,48 154,27	439453	Ⓛ	m ²
	Kerdi-200 polietilenska hidroizolacijska membrana pogodna za postavljanje na pod i zid, spojevi se brtve ljepljivom Kerdi Coll-L. Širina 2 m, dužina 30 m.	19,05 143,50	830449	Ⓛ	m ²
	Kerdi-Keba vodonepropusna traka od polietilena za brtvljenje spojeva. Širina 12,5 cm, dužina 5 m.	4,06 30,60	433009	Ⓛ	mL

		MPC (€) MPC (Kn)	Šifra artikla	Dostupnost	Mjerna jedinica
	Kerdi-Keba vodonepropusna traka od polietilena za brtvljenje spojeva. Širina 12,5 cm, dužina 30 m.	3,51 26,43	433008	Ⓛ	mL
	Kerdi Kereck unutarnji kut, set od dva komada.	15,58 117,35	433013	Ⓛ	set
	Kerdi Kereck vanjski kut, set od dva komada.	18,23 137,32	433014	Ⓛ	set
	Kerdi Coll-L ljepilo prikladno za ljepljenje i brtvljenje preklopa Kerdi-200 te za ljepljenje brtvene trake Kerdi-Keba, 6 kg.	10,14 76,42	1160878	Ⓛ	kg
	Kerdi-Board paneli koji se koriste za oblaganje kade, vodokotlića, izradu pregradnih zidova, niša, pulteva u kupaonici, dimenzija 62,5 x 260 x h 0,5 cm.	28,63 215,75	480866	Ⓛ	m ²
	Kerdi-Board paneli koji se koriste za oblaganje kade, vodokotlića, izradu pregradnih zidova, niša, pulteva u kupaonici, dimenzija 62,5 x 260 x h 0,9 cm.	30,03 226,23	583248	Ⓛ	m ²
	Kerdi-Board paneli koji se koriste za oblaganje kade, vodokotlića, izradu pregradnih zidova, niša, pulteva u kupaonici, dimenzija 62,5 x 260 x h2,8 cm.	42,36 319,17	469296	Ⓛ	m ²
	Kerdi-Board paneli koji se koriste za oblaganje kade, vodokotlića, izradu pregradnih zidova, niša, pulteva u kupaonici, dimenzija 62,5 x 260 x h5 cm.	49,72 374,61	458040	Ⓛ	m ²
	Ditra heat E-Duo S7 električno podno grijanje. Set sadržava razdvojnu membransku ploču, grijači kabel, termostat za zaslon osjetljiv na dodir s WiFi-jem, dvije razvodne kutije i valovito crijevo. Namijenjeno za 3,3 m ² .	733,38 5.525,68	604552	Ⓛ	set
	Ditra heat E-Duo S7 električno podno grijanje. Set sadržava razdvojnu membransku ploču, grijači kabel, termostat za zaslon osjetljiv na dodir s WiFi-jem, dvije razvodne kutije i valovito crijevo. Namijenjeno za 3,8 m ² .	645,80 4.865,81	859549	Ⓛ	set
	Ditra heat E-Duo S7 električno podno grijanje. Set sadržava razdvojnu membransku ploču, grijači kabel, termostat za zaslon osjetljiv na dodir s WiFi-jem, dvije razvodne kutije i valovito crijevo. Namijenjeno za 4,4 m ² .	587,91 4.429,57	859548	Ⓛ	set

Sjedište i prodajni salon Poreč

Mate Vlašića 43a, 52440 Poreč

TEL: +385 52 45 13 48 | FAX: +385 52 43 40 05

Prodajni salon Pula

Jurja Žakna 4a, 52100 Pula

TEL: +385 52 21 90 02 | FAX: +385 52 21 91 18

Prodajni salon Matulji (Rijeka)

Jušići 47d, 51213 Jurdani

TEL: +385 51 74 13 00 | FAX: +385 51 74 12 98

Prodajni salon Zagreb

Ivana Zahara 3, 10000 Zagreb

TEL: +385 1 34 92 552 | FAX: +385 1 34 92 560

Prodajni salon Varaždin

Kučanmarofska ulica 2, 42000 Varaždin

TEL: +385 42 30 37 07 | FAX: +385 42 30 37 09

Prodajni salon Dugopolje (Split)

Sv. Duje 8, 21204 Dugopolje

TEL: +385 21 66 89 80 | FAX: +385 21 66 89 90

www.spina.hr

info@spina.hr

NAKLADNIK

AUTOR TEKSTA

FOTOGRAFIJE

GRAFIČKO OBLIKOVANJE

TISAK

Špina d.o.o.

Špina d.o.o.

dobavljači

Studio Sonda d.o.o.

Sigra grafički obrt

